

02.2025



1964
2024
60
ANNIVERSARY



MACCHINE PER L'AGRICOLTURA
AGRICULTURAL MACHINERY
LANDWIRTSCHAFTLICHE MASCHINEN
MAQUINARIA DE AGRICULTURA
MACHINES AGRICOLES

Cod. C6474010



Consulta i nostri cataloghi online per avere gli ultimi aggiornamenti!

Zanon srl si riserva di apportare variazioni senza alcun preavviso

Check out our online catalogues for the latest updates!

Zanon srl reserves the right to make changes without prior notice

zanon.it



HEADQUARTERS CAMPODARSEGO
Sede centrale di Campodarsego (via Madonnetta, 30)



PRODUCTION FACILITY AND WAREHOUSE
Sede produttiva di Cadoneghe (via Tiepolo, 20)



PRODUCTION FACILITY AND WAREHOUSE
Sede prod. e magazzino di Campodarsego (via Antoniana, 286)



Rete commerciale Italia

Nome	Zona	Telefono	e-mail
Cordero Sergio	Piemonte - Valle D'Aosta	+39 335 5461095	sergiocordero@libero.it
Chiaromonte Giovanni	Lombardia	+39 340 8154190 +39 035 0393440	chiaromonte.gio@gmail.com
Caprioli Mauro	Liguria	+39 335 7353816	caprioli.mauro@libero.it
Volpato Simone	Veneto (prov. Belluno e Venezia escluse) - Trentino (prov. Trento)	+39 348 3762501	commerciale@zanon.it
Venturini Lorenzo	Friuli-Venezia-Giulia - Veneto (prov. Belluno e Venezia)	+39 348 4986685	lorenzo.venturini@libero.it
Giulianini Fabio	Emilia-Romagna	+39 335 242893	fgiulianini@gmail.com
Gagliardi Damiano	Toscana	+39 348 7773803	gagliardid@virgilio.it
Palma Adriano	Lazio (prov. Viterbo, Rieti, Roma) - Umbria	+39 335 5725192	adriano.palma11@gmail.com
Gelosia Nicolò	Lazio	+39 348 8302066	nico.gelosia@gmail.com
Gulinelli Stefano	Lazio (prov. Latina, Frosinone, Roma)	+39 392 4578765	stefano.gulinelli@gmail.com
Di Mascio Vincenzo	Abruzzo e Molise	+39 335 6890841	dimar_v@libero.it
Mazzariello Antonio	Campania - Marche CAPOAREA CENTRO-SUD (Campania/Abruzzo/Molise/Puglia/Basilicata/Calabria/Sardegna)	+39 338 4407853	antonio.mazzariello@zanon.it
Dibello Michele	Puglia	+39 333 6188280	dibellomichele@hotmail.com
Guidi Francesco	Basilicata e Calabria	+39 349 8171790	francescoguidi.1989@gmail.com
Amico Andrea	Sicilia	+39 393 9712624	geoamix@gmail.com
Piras Alessandro	Sardegna	+39 392 2884519	primabase1@gmail.com

Export area manager

Name	Area	Telephone	e-mail
Agustín Javier	Spain (M.A.)	+34 649 547 991	jaugustin@zanon.it
Bellotto Dario	China	+39 342 3804206	dario.b@zanon.it
Cervellati Roberto	Argentina - Bolivia - Brazil - Chile - Colombia - Ecuador - Peru - Uruguay	+57 (310) 438-8213	latam@zanon.it
Giusti Cristina	Bulgaria - Georgia - Azerbaijan - Armenia		export3@zanon.it
Guarnieri Leonardo	Germany - Austria - Switzerland (German canton) South Tyrol (prov. Bolzano)	+39 345 5661837	leonardo.g@zanon.it
Lefter Aurel	Romania - Moldavia	+40 766 358006	lefter_aurel@yahoo.com
Lorenzon Daniela	France - Switzerland (French canton) - Belgium - Netherlands - Denmark Norway - Tunisia - Algeria - UAE - India - Morocco - Jordan - Lebanon	+39 342 1012614	daniela.l@zanon.it
Pretz Hugo	Hungary - Serbia - North Macedonia - Montenegro - Bosnia and Herzegovina Kosovo - Czech Republic - Slovak Republic - Poland	+39 392 0367609 +381 601407999	hugo.p@zanon.it
Zanon Filippo	Slovenia - Croatia		filippo.zanon@zanon.it
Zanon Giada	Ukraine - Russia - Estonia - Latvia - Lithuania - Sweden - Finland		giada.zanon@zanon.it
Zanello José Luis	Spain - Portugal - United Kingdom - Albania - Ireland - Greece - Cyprus Türkiye - Canada - Mexico - USA - South Africa - Israel - Korea - Japan Australia - New Zealand	+39 392 8315554 +34 696 348 891	jzanello@zanon.it

TRINCIA MULCHER MULCHGERÄT TRITURADORA BROYEUR			
TSM MONOLAMA	22		
TSM OFF-ROAD	24		
RYDER	26		
RYDER TRACTOR	28		
TSS	30		
TFL	32		
TFL-S	34		
TFX	36		
TFM/P	38		
TFZ	40		
TFZ-PRO	NEW 42		
IT-M	44		
IT	46		
IT-PRO	48		
DMI	50		
TFG	52		
TFA	54		
TFO	56		
TDR	58		
TSP	60		
LFG	62		
TFB	64		
TMU	66		
TMS	68		
TMS-PRO	NEW 70		
TSF	72		
TSF-PRO	NEW 74		
ZTS	76		
ZTS-DT	78		
ZTS-MEGA	NEW 80		
ZTS TWIN	82		
TRE-PRO	84		
TRL	NEW 86		
TFM/R	88		
TRV-PRO	90		
TRG	92		
RFG	94		
TRP	96		
TMR	98		
TMR-PRO	100		
TCK	102		
TLK	104		
TLK-PRO	NEW 106		
TMK	108		
TMK-PRO	NEW 110		
TPK	NEW 112		
TLP	114		
TMP	116		
TM	118		
TL	120		
TF/DT SPECIAL	122		
TN/DT SPECIAL	124		
TMJ	126		
TMO	128		
TMO-SE	130		
TMC	132		
TMH	134		
TMH-PRO	136		
TMA-S	138		
TPE	140		
KIT FARI WIRELESS WIRELESS LIGHTS KIT KABELLOSES LED-LICHT-KIT KIT LUCES LED TIPO INALÁMBRICO KIT DE FEUX À LED SANS FIL		142	
RASAERBA MOWER RASENMÄHER SEGADORA DE CÉSPED TONDEUSE			
ROBY-PRO 550	NEW 144		
ROBY-PRO 800	NEW 145		
ZRA BILAMA	146		
DISTRUGGI ERBA SHREDDER GRASZERKLEINER TRITURADORA DE HIERBA GIROBROYEUR POUR MTC			
FALK	148		
ARIEGGIATORE AERATOR VERTIKUTIERER ESCARIFICADOR AÉRATEUR			
AR ARIEGGIATORE	150		
FALCIATRICE ROTANTE ROTARY MOWER TROMMELMÄHWER FÜR EINACHSER SEGADORA ROTATIVA ROTOFAUCHEUSE			
ZRF FALCIATRICE	152		
ZRF-T FALCIATRICE	154		
ZRF-TL FALCIATRICE	156		
SPACCALEGNA LOG SPLITTER HOLZSPALTER ASTILLADORA DE TRONCO FENDEUSE À BOIS			
SLE-8	158		
SLS-8	159		
SLE-9	160		
SLT-9.5	161		
SLE-10	162		
SLT-10	164		
SLS-10	166		
SVE-10/12	167		
SVT-10/12	168		
SVE-16 ECOLINE	169		
SVT-16 ECOLINE	170		
SVEK-14/16	171		
SVTK-14/16	172		
SVE-20	173		
SVT-20	174		
SVI-20	175		
SVT-25	176		
BIOTRITURATORI e MINI-DUMPERS WOOD CHIPPER and MINI-DUMPERS HOLZHÄCKSLER und MINIRAUPENDUMPER BIOTRITURADORAS y MINI-DUMPERS BROYEURS DE VÉGÉTAUX et MINI-TOMBREAUX			
CIP 100-S	NEW 180		
CIP 120-S	NEW 182		
BC 30	184		
BC 50-S	185		
BC 50-T	186		
BC 60-E	187		
BC 60-S	188		
BC 60-T	189		
BC 90-S	190		
BC 90-T	191		
BC 90-CINGO	192		
MINI DUMPER DP 300	193		
BIO 8-B	194		
BIO 8-E	195		
BIO 8-T	196		
BIO 10-B	197		
BIO 130-S	NEW 198		
BIO 160-T	200		
DC 300-B	NEW 202		
DC 500-B/DC 500-BH	NEW 203		
Richiesta di primo avviamento Conditions required for initial commissioning Voraussetzungen für die erste Inbetriebnahme Condiciones para la primera puesta en marcha Conditions nécessaires au premier démarrage			204
Condizioni generali di vendita General terms and conditions of sale Allgemeine Verkaufsbedingungen Condiciones generales de venta Conditions générales de vente			207



1964
2024
60
ANNIVERSARY



	Attacco motocoltivatore Two-wheel tractor connection Einachser Adapter Acople a motocultor Montage sur motoculteur		Dimensioni macchina Machine dimensions Abmessungen der Maschine Dimensiones de la máquina Dimensions de la machine		Requisiti del trattore (larghezza cm) Tractor requirements (width in cm) Traktor Anforderungen ((Breite in cm) Requisitos del tractor (anchura en cm) Exigences relatives au tract. (largeur cm)		Lama per biotrituratore Blades for wood chipper Messer für Holzhäcksler Cuchilla para biotrituradora Lames pour broyeur de végétaux
	Attacco a cardano Pto shaft connection Anschluss Gelenkwelle Acoplamiento a cardán Entraînement par cardan		Dimensioni trincia Mulcher dimensions Abmessungen Mulcher Dimensiones de la trituradora Dimensions du broyeur		Giri al minuto PTO Revolutions per minute PTO Umdrehungen pro Minute PTO Zapfwelle Revoluciones por minuto TDF Révolutions par minute PDF		Controlama per biotrituratore Counterblade for wood chipper Gegenmesser für Holzhäcksler Contracuchilla para biotrituradora Contre-lames pour broyeur de végétaux
	Attacco alle prese idrauliche Hydraulic tractor connection Hydraulischer Traktoranschluss Tomas hidráulicas del tractor Entraînement hydraulique		Dimensioni biotrituratore Wood chipper dimensions Abmessungen der Holzhäcksler Dimensiones de la biotrituradora Dimensions du broyeur de végétaux		Senso di rotazione PTO Direction of PTO rotation Drehrichtung der Zapfwelle Dirección de rotación de la TDF Sens de rotation de la PDF		Aste di raccolta sarmanti Twig rakes Holzaufnahmezinken Astas de cosecha Tiges de ramassage
	Alimentazione motore a scoppio Combustion engine Angetrieben durch Verbrennungsmotor Alimentado por motor a explosión Entraînement par moteur thermique		Modello macchina Machine model Maschinenmodell Modelo de la máquina Modèle de la machine		Cardano PTO drive shaft Gelenkwelle Transmisión cardanica Cardan		Alette spargitrici Spreading wings Verteilerflügel Aletas esparciadoras Ailettes de dispersion
	Alimentazione motore elettrico Powered electric motor Angetriebener Elektromotor Alimentado por motor eléctrico Entraînement par moteur électrique		Codice macchina Machine code Maschinencode Código máquina Code de la machine		Cardano con frizione PTO drive shaft with friction Gelenkwelle mit Rutschkupplung Transmisión cardanica con embrague Cardan avec embrayage à friction		Spuntoni di raccolta TCK Harvesting spikes for TCK Ripperzähne für TCK Púas de recogida TCK Dents de ramassage TCK
	Direzione di lavoro macchina Working direction machine Maschinenarbeitsrichtung Dirección trabajo máquina Sens de travail de la machine		Codice macchina versione destra Machine code - right version Maschinencode - Rechte Version Código máquina - versión derecha Code machine - version droit		Numero/modello cinghie Number-model of belts Anzahl-Modell der Riemen Cantidad-modelo de correas Nombre-modelle de courroies		Spuntoni di raccolta TF/TN Harvesting spikes for push frame TF/TN Ripperzähne Druckevorrichtung TF/TN Púas de recogida TF/TN Dents de ramassage TF/TN
	Direzione di lavoro macchina Working direction machine Maschinenarbeitsrichtung Dirección trabajo máquina Sens de travail de la machine		Codice macchina versione sinistra Machine code - left version Maschinencode - linke Version Código máquina - versión izquierda Code machine - version gauche		Gruppo spostamento Idraulico Hydraulic side shift Hydraulische Verschiebung Kit desplazador hidráulico Groupe de déplacement latéral		Diametro massimo di taglio Maximum cutting diameter Maximaler Schnittdurchmesser Diámetro máximo de corte Diamètre maximum de coupe
	Direzione di lavoro macchina Working direction machine Maschinenarbeitsrichtung Dirección trabajo máquina Sens de travail de la machine		Codice macchina a coltelli Machine code - blades version Maschinencode - Messer Version Código máquina - versión cuchillas Code machine - version couteaux		Dimensioni rotore trincia Dimensions rotor mulcher Abmessungen Rotormulcher Dimensiones de rotor de la trituradora Dimensions du rotor broyeur		Altezza massima di taglio Maximum cutting height Maximale Schnitthöhe Altura máxima de corte Hauteur de coupe maximale
	Direzione di lavoro macchina Working direction machine Maschinenarbeitsrichtung Dirección trabajo máquina Sens de travail de la machine		Codice macchina a mazze Machine code - hammers version Maschinencode - Hammer Version Código máquina - versión martillos Code machine - version marteaux		Coltelli per rasaerba Blades for lawn mower Messer für Rasenmäher Cuchillos de siega Couteaux de tonte		Giri al minuto rotore Rotor revolutions per minute Rotorumdrehungen pro Minute Revoluciones por minuto rotor Vitesse du rotor
	Direzione di lavoro macchina Working direction machine Maschinenarbeitsrichtung Dirección trabajo máquina Sens de travail de la machine		Peso macchina Machine weight Gewicht der Maschine Peso de la máquina Poids de la machine		Coltelli per trincia Blades for mulcher Messer für Mulchgeräte Cuchillos para trituradoras Couteaux pour broyeurs		Giri al minuto rotore Rotor revolutions per minute Rotorumdrehungen pro Minute Revoluciones por minuto rotor Vitesse du rotor
	Direzione di lavoro macchina Working direction machine Maschinenarbeitsrichtung Dirección trabajo máquina Sens de travail de la machine		Larghezza di lavoro rasaerba Lawnmower working width Arbeitsbreite des Rasenmähers Ancho de trabajo de la segadora Largeur de travail de la tondeuse		Coltello "arieggiatore" Straight aeration blade Vertikutierer Messer Cuchilla "escarificador" Couteau "scarificateur"		Produzione oraria Hourly production Stündliche Produktion Producción horaria Rendement horaire
	Spostamento macchina Lateral side shift Seitliche Seitenverschiebung Desplazamiento de la máquina Déplacement de la machine		Larghezza di lavoro Working width Arbeitsbreite Ancho de trabajo Largeur de travail		Mazza per trincia Hammer for mulcher Hammer für Mulchgeräte Martillo para trituradora Marteau pour broyeur		Spinta cilindro spaccalegna Thrust cylinder log-splitter Spaltkraft Holzspaltzylinder Presion de trabajo cilindro astilladora Poussée vérin de fendeuse
	Spostamento macchina Lateral side shift Seitliche Seitenverschiebung Desplazamiento de la máquina Déplacement de la machine		Potenza Power Leistung Potencia Puissance		Dente - W Utensils - W Werkzeug - W Utensillos - W Utensils - W		Capacità serbatoio dell'olio Oil tank capacity Fassungsvermögen des Öltanks Capacidad del tanque de aceite Capacité du réservoir d'huile
	Spostamento macchina Lateral side shift Seitliche Seitenverschiebung Desplazamiento de la máquina Déplacement de la machine		Potenza richiesta motocoltivatore Power required two-wheel tractor Leistungsbedarf Einachser Potencia requerida motorcultivador Puissance requise motorcultivateur		Ø vite per utensile Ø screw for tool Ø Schraube für Werkzeug Ø tornillo para herramienta Ø vis pour outil		Quantità di olio necessaria Quantities of oil required Benötigte Ölmenge Cantidades de aceite requerida Quantité d'huile nécessaire
	Ingombro macchina in lavoro Dimensions machine in work Abmessungen Maschine in Arbeit Dimensiones de la máquina en trabajo Encombrement de la machine au travail		Potenza richiesta alla trattrice Power required from the tractor Benötigte Leistung vom Traktor Potencia requerida del tractor Puissance requise du tracteur		Peso utensile Tool weight Werkzeuggewicht Peso de la herramienta Poids de l'outil		Larghezza di lavoro Working width Arbeitsbreite Ancho de trabajo Largeur de travail
	Ingombro macchina in lavoro Dimensions machine in work Abmessungen Maschine in Arbeit Dimensiones de la máquina en trabajo Encombrement de la machine au travail		Requisiti del trattore (HP-kg) Tractor requirements (HP-kg) Traktor Anforderungen (HP-kg) Requisitos del tractor (HP-kg) Exigences relatives au tracteur (HP-kg)		Coltelli per biotrituratore Blades for wood chipper Klingen für Holzhäcksler Martillo para biotrituradora Marteau pour broyeur de végétaux		Pressione olio Oil pressure Öldruck Presión del aceite Pression d'huile



1964
2024
60
ANNIVERSARY



La Storia... Continua...

L'autentico
"made in Italy"
per chi ama
la professionalità!

Orientata al continuo miglioramento ed alla piena soddisfazione della propria clientela, negli ultimi anni ZANON ha realizzato una serie di investimenti nei settori produttivo, tecnico e commerciale volti all'ottimizzazione dei processi con impianti di ultimissima generazione, innovativi e di recente installazione.

Abbiamo accolto le più avanzate tecnologie produttive con le quali siamo riusciti a ridurre al minimo gli sprechi e i difetti di fabbricazione, migliorando sensibilmente gli standard qualitativi e conferendo ai nostri prodotti quel valore aggiunto che li contraddistingue nel mercato mondiale.

Trattiamo esclusivamente materiali affidabili, certificati, attentamente selezionati presso i migliori fornitori.

La nostra professionalità trova poi conferma in tutti i test di qualità eseguiti in azienda prima della consegna, nell'accurata assistenza e gestione del servizio post-venta.

The authentic
"made in Italy" for
those who love
professionalism!

Oriented towards continuous improvement and full customer satisfaction, in recent years ZANON has made a series of investments in the production, technical and commercial sectors aimed at process optimization with the latest generation, innovative and recently installed systems.

We have adopted the most advanced production technologies with which we have managed to reduce waste and manufacturing defects to a minimum, significantly improving quality standards and giving our products the added value that sets them apart on the world market.

We deal exclusively with reliable, certified, carefully selected materials from the best suppliers.

Our professionalism is then confirmed in all the quality tests carried out in the company before delivery, in the accurate assistance and after-sales service management.

Das authentische
"made in Italy" für alle,
die Professionalität
lieben!

Orientiert an kontinuierlicher Verbesserung und voller Kundenzufriedenheit, hat ZANON in den letzten Jahren eine Reihe von Investitionen im Produktions, technischen und kommerziellen Bereich getätigt, die auf eine Prozessoptimierung mit innovativen und kürzlich installierten Systemen der neuesten Generation abzielen.

Wir haben die fortschrittlichsten Produktionstechnologien eingesetzt, mit denen es uns gelungen ist, Abfall und Herstellungsfehler auf ein Minimum zu reduzieren, die Qualitätsstandards deutlich zu verbessern und unseren Produkten den Mehrwert zu verleihen, der sie auf dem Weltmarkt auszeichnet.

Wir handeln ausschließlich mit zuverlässigen, zertifizierten, sorgfältig ausgewählten Materialien von den besten Lieferanten.

Unsere Professionalität wird dann in allen im Unternehmen vor der Auslieferung durchgeführten Qualitätstests, in der sorgfältigen Betreuung und im Kundendienstmanagement bestätigt.

¡El auténtico
"hecho en Italia"
para los amantes de
la profesionalidad!

Orientada hacia la mejora continua y la plena satisfacción de los clientes, ZANON ha realizado una serie de inversiones en los sectores productivos, técnicos y comerciales, para la optimización de los procesos, contando con sistemas de última generación, innovadores y de reciente instalación.

Hemos adoptado las tecnologías de producción más avanzadas, lo que nos ha permitido optimizar la producción, garantizar un elevado nivel de calidad cumpliendo los estándares de calidad más rigurosos a nivel mundial lo que facilita la competitividad de nuestros productos a nivel mundial.

Tratamos única y exclusivamente materiales fiables, certificados, cuidadosamente seleccionados entre los mejores proveedores.

Nuestra profesionalidad encuentra una confirmación adicional en los test de calidad realizados antes de la entrega, así como en la cuidadosa asistencia y gestión del servicio posventa.

L'authentique
"made in Italy" pour
ceux qui aiment le
professionnalisme!

Orientée vers l'amélioration continue et la pleine satisfaction de ses clients, ZANON a réalisé ces dernières années une série d'investissements dans les secteurs de la production, technique et commercial visant à optimiser les processus avec des systèmes de dernière génération, innovants et récemment installés.

Nous avons mis en œuvre les technologies de production les plus avancées avec lesquelles nous avons été en mesure de minimiser les déchets et les défauts de fabrication, en améliorant considérablement les normes de qualité et en donnant à nos produits la valeur ajoutée qui les distingue sur le marché mondial.

Nous ne travaillons qu'avec des matériaux fiables et certifiés, soigneusement sélectionnés parmi les meilleurs fournisseurs.

Notre professionnalisme est ensuite confirmé dans tous les tests de qualité effectués dans l'entreprise avant la livraison, dans l'assistance attentive et la gestion du service après-vente.





Equilibratura dei rotori: perché è importante?

Dove si trovano parti in rotazione, anche un lieve squilibrio può portare ad elevate vibrazioni e a gravi danni dei componenti.

Alla lunga, questa vibrazione può portare alla rottura dei rotori.

Per questo motivo eseguiamo quotidianamente l'equilibratura dinamica di tutti i rotori delle nostre trincia, finalizzata a rimuovere ogni vibrazione, ridurre la rumorosità, i consumi energetici e permettere al rotore un lavoro lineare.

L'equilibratura dei rotori è quindi molto importante, poiché ne va della qualità e della durata operativa della macchina, nonché della sicurezza dell'operatore.

Rotor balancing: why is it important?

Where rotating parts are found, even a slight imbalance can lead to high vibrations and serious damage to the components.

In the long run, this vibration can lead to rotor failure.

For this reason we perform daily dynamic balancing of all rotors of our mulchers, aimed at removing all vibrations, reducing noise, energy consumption and allowing the rotor to work linearly.

The balancing of the rotors is therefore very important, as it affects the quality and operating life of the machine, as well as the safety of the operator.

Rotorauswuchten: Warum ist es wichtig?

Wo sich rotierende Teile befinden, kann schon eine geringe Unwucht zu hohen Vibrationen und schwerwiegenden Schäden an den Komponenten führen. Auf lange Sicht können diese Vibrationen zum Ausfall des Rotors führen. Aus diesem Grund führen wir täglich ein dynamisches Auswuchten aller Rotoren unserer Mulchgeräte durch, mit dem Ziel, alle Vibrationen zu beseitigen, den Lärm und Energieverbrauch zu reduzieren und den Rotor linear arbeiten zu lassen. Das Auswuchten der Rotoren ist daher sehr wichtig, da es sich auf die Qualität und Lebensdauer der Maschine sowie auf die Sicherheit des Bedieners auswirkt.

Equilibrado del rotor: ¿porque es importante?

Donde se encuentran partes en rotación, a las velocidades a la que giran los rotores, un desequilibrio leve puede generar una alta vibración, generando daños a los componentes de la maquina, por ejemplo, grietas en soldadura, rotura de rodamientos, etc.

Por el motivo arriba mencionado es que nuestros rotores están equilibrados con la más extrema precisión posible, lo que se traduce en una mayor vida útil de los elementos en movimiento, como son los rodamientos. El equilibrado del rotor, es sumamente importante, debería de ser efectuado a cada cambio de juego de martillos, lo que garantiza una vida prolongada del equipo en cuestión.

Équilibrage du rotor: pourquoi est-ce important?

Là où il y a des pièces en rotation, même un léger déséquilibre peut entraîner des vibrations élevées et de graves dommages aux composants. A long terme, cette vibration peut conduire à la casse des rotors.

Pour cette raison, nous effectuons un équilibrage dynamique systématique de tous les rotors de nos broyeur, visant ainsi à éliminer toute vibration, réduire le bruit, la consommation d'énergie et permettre au rotor de fonctionner de manière fluide.

L'équilibrage des rotors est donc très important, car il affecte la qualité et la durée de vie de la machine, ainsi que la sécurité de l'opérateur »



Processo:
**SABBIATURA +
VERNICIATURA A POLVERE**

Sabbiatura: Sa2^{1/2}

Finitura: in polvere poliesteri ACE
alta durabilità

Polimerizzazione:
a 180° per 20'

Spessore finale secco:
60-80 µm

Colore: giallo, blu e varie
colorazioni speciali

**Classe di corrosività UNI EN ISO
12944:** C3-High

**Resistenza in nebbia salina ISO
9227 - ASTM B117:**
500 ore

Process:
**SANDBLASTING +
POWDER COATING**

Sandblasting: Sa2^{1/2}

Finish: high durability ACE
polyester powder

Polymerization:
at 180° for 20'

Thickness final dry:
60-80 µm

Color: yellow, blue and various
special colors

**Corrosivity class UNI EN ISO
12944:** C3-High

**Salt spray resistance ISO 9227 -
ASTM B117:**
500 hours

Verfahren:
**SANDSTRAHLEN +
PULVERBESCHICHTUNG**

Sandstrahlen: Sa2^{1/2}

Fertigstellung: ACE-Polyesterpulver
mit hoher Strapazierfähigkeit

Polymerisation:
bei 180° für 20'

Dicke Endtrocknung:
60-80 µm

Farbe: gelb, blau und verschiedene
Sonderfarben

**Korrosivitätsklasse UNI EN ISO
12944:** C3-Hoch

**Beständigkeit gegen
Salzsprühnebel ISO 9227 -
ASTM B117:** 500 Stunden

Proceso:
**CHORRO DE ARENA +
RECUBRIMIENTO EN POLVO**

Chorro de arena: Sa2^{1/2}

Acabado: polvo de poliéster ACE
de alta durabilidad

Polimerización:
a 180° por 20'

Espesor final seco:
60-80 µm

Color: amarillo, azul y varios
colores especiales

**Clase de corrosividad UNI EN
ISO 12944:** C3-Alta

**Resistencia a la niebla salina
ISO 9227 - ASTM B117:**
500 horas

Traiter:
**SABLAGE +
ÉREVÊTEMENT EN POUVRE**

Sablage: Sa2^{1/2}

Finition: poudre de polyester ACE
haute durabilité

Polymérisation:
à 180° pendant 20'

Épaisseur finale à sec:
60-80 µm

Couleur: jaune, bleu et diverses
couleurs spéciales

**Classe de corrosivité UNI EN ISO
12944:** C3-High

**Résistance au brouillard salin
ISO 9227 - ASTM B117:**
500 heures

PREMIUM COATING QUALITY



ZOCCARATO
INDUSTRIAL COATINGS



Superficie verniciata blu
Blue painted surface
Blau lackierte Fläche
Superficie pintada de azul
Surface peinte en bleu



Lamiera grezza
Raw sheet metal
Rohes Metallblech
Chapa en bruto
Tôle brute

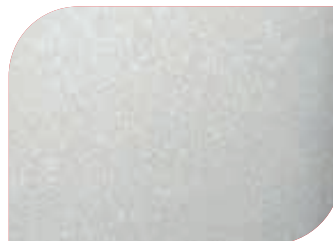

Lamiera sabbiata
Sandblasted sheet
Sandgestrahltes Blech
Chapa arenada
Tôle sablée



Superficie verniciata giallo
Yellow painted surface
Gelb lackierte Fläche
Superficie pintada de amarillo
Surface peinte en jaune



Processo:
SABBIATURA +
CATAFORESI +
VERNICIATURA A POLVERE

Process:
SANDBLASTING +
CATAPHORESIS +
POWDER COATING

Verfahren:
SANDSTRAHLEN +
KATAPHORESE +
PULVERBESCHICHTUNG

Proceso:
CHORRO DE ARENA +
CATAFORESIS +
RECUBRIMIENTO EN POLVO

Traiter:
SABLAGE +
CATAPHORESE +
REVÊTEMENT EN POUDRE

Sabbatura: Sa2^{1/2}
Fosfatazione ai sali di zinco
ISO9717
Fondo cataforesi epossidica
POWERCRON® 6000HE
Spessore fondo cataforesi:
20 µm
Finitura: in polvere poliestere ACE
alta durabilità
Polimerizzazione:
a 180° per 20'
Spessore finale secco:
80-120 µm
Colore: giallo, blu e varie
colorazioni speciali
Classe di corrosività UNI EN ISO
12944: C5-Medium
Resistenza in nebbia salina ISO
9227 - ASTM B117:
superiore a 1.000 ore

Sandblasting: Sa2^{1/2}
ISO9717
zinc salts phosphating
POWERCRON® 6000HE epoxy
cataphoresis primer
Cataphoresis bottom thickness:
20 µm
Finish: high durability ACE
polyester powder
Polymerization:
at 180° for 20'
Thickness final dry:
80-120 µm
Color: yellow, blue and various
special colors
Corrosivity class UNI EN ISO
12944: C5-Medium
Salt spray resistance ISO 9227 -
ASTM B117:
more than 1,000 hours

Sandstrahlen: Sa2^{1/2}
ISO9717
Zinksalze Phosphatierung
POWERCRON® 6000HE Epoxid-
Kataphorese-Grundierung
Dicke des Kataphoresebodens:
20 µm
Fertigstellung: ACE-Polyesterpulver
mit hoher Strapazierfähigkeit
Polymerisation:
bei 180° für 20'
Dicke Endtrocknung:
80-120 µm
Farbe: gelb, blau und verschiedene
Sonderfarben
Korrosivitätsklasse UNI EN ISO
12944: C5-Mittel
Beständigkeit gegen
Salzsprühnebel ISO 9227 -
ASTM B117:
mehr als 1.000 Stunden

Chorro de arena: Sa2^{1/2}
Fosfatación de sales de zinc
ISO9717
Imprimación de cataforesis
epoxi POWERCRON® 6000HE
Grosor del fondo de cataforesis:
20 µm
Acabado: polvo de poliéster ACE
de alta durabilidad
Polimerización:
a 180° por 20'
Espesor final seco:
80-120 µm
Color: amarillo, azul y varios
colores especiales
Clase de corrosividad UNI EN
ISO 12944: C5-Medio
Resistencia a la niebla salina
ISO 9227 - ASTM B117:
más de 1.000 horas

Sablage: Sa2^{1/2}
Phosphatation des sels de zinc
ISO9717
Primaire époxyde cataphorese
POWERCRON® 6000HE
Épaisseur du fond de
cataphorese: 20 m
Finition: poudre de polyester ACE
haute durabilité
Polymérisation:
à 180° pendant 20'
Épaisseur finale à sec:
80-120 µm
Couleur: jaune, bleu et diverses
couleurs spéciales
Classe de corrosivité UNI EN ISO
12944: C5-Medium
Résistance au brouillard salin
ISO 9227 - ASTM B117:
plus de 1 000 heures

PREMIUM COATING QUALITY



ZOCCARATO
INDUSTRIAL COATINGS



Superficie verniciata blu
Blue painted surface
Blau lackierte Fläche
Superficie pintada de azul
Surface peinte en bleu



Lamiera grezza
Raw sheet metal
Rohes Metallblech
Chapa en bruto
Tôle brute



Lamiera sabbiata
Sandblasted sheet
Sandgestrahltes Blech
Chapa arenada
Tôle sablée

























Fondo cataforesi
Cataphoresis base
Kataphorese-Basis
Fondo de cataforesis
Fonds de cataphorese

















Superficie verniciata giallo
Yellow painted surface
Gelb lackierte Fläche
Superficie pintada de amarillo
Surface peinte en jaune







MACCHINE MACHINES		LARGHEZZA DI LAVORO WORKING WIDTH	POTENZA TRATTORE TRACTOR POWER	PESO WEIGHT	ATTACCO AL TRATTORE LINKAGE TO THE LIFTER		
Modello Model		cm	HP	kg	Frontale Front	Posteriore Rear	Reversibile Reversible
	TSM	62	7 - 11	88	●	●	
		92	12 - 18	104	●	●	
		110	14 - 25	120	●	●	
	TSM-T	92	12 - 18	110		●	
		110	14 - 25	125		●	
	TSM OFF-ROAD	100	QUAD RIDER ATV	155		●	
		125		170		●	
	RYDER	140	15 - 45	210	●		
		160	15 - 45	250	●		
	RYDER TRACTOR	140	30 - 40	260	●		
		160	30 - 40	290	●		
	TSS	100	12 - 30	105		●	
		125	15 - 30	115		●	
	TFL	100	12 - 40	190		●	
		115	12 - 40	205		●	
		130	15 - 40	220		●	
		150	20 - 40	235		●	
	TFL-S	130	15 - 40	250		●	
		150	20 - 40	265		●	
	TFX	130	25 - 60	310		●	
		150	30 - 60	335		●	
		170	35 - 60	365		●	
		190	35 - 80	395		●	
	TFM/P	130	25 - 60	265		●	
		150	30 - 60	305		●	
		170	35 - 60	345		●	
		190	35 - 80	386		●	
	TFZ	140	30 - 100	415		●	
		160	30 - 100	445		●	
		190	40 - 100	500		●	
	TFZ-PRO	160	30 - 100	485		●	
		190	40 - 100	565		●	
		225	50 - 100	605		●	
		250	60 - 100	660		●	
		270	80 - 120	690		●	
	TFG	85	15 - 60	320		●	
		100	15 - 60	380		●	
		120	20 - 60	420		●	
	TFA	130	30 - 70	420		●	
		140	30 - 70	450		●	
		160	40 - 70	510		●	
		180	40 - 70	550		●	
		200	50 - 90	620		●	
		220	60 - 90	690		●	





MACCHINE MACHINES		LARGHEZZA DI LAVORO	POTENZA TRATTORE	PESO	ATTACCO AL TRATTORE		
		WORKING WIDTH	TRACTOR POWER	WEIGHT	LINKAGE TO THE LIFTER		
Modello Model		cm	HP	kg	Frontale Front	Posteriore Rear	Reversibile Reversible
	TF0	160	40 - 70	560		•	
		180	40 - 70	625		•	
		200	50 - 70	685		•	
		220	60 - 90	750		•	
		240	60 - 90	815		•	
	TDR	140	35 - 70	680	•	•	•
		160	40 - 70	750	•	•	•
		180	50 - 70	820	•	•	•
		200	60 - 90	890	•	•	•
		220	70 - 90	960	•	•	•
		240	80 - 100	1030	•	•	•
		260	90 - 130	1100	•	•	•
		280	90 - 130	1170	•	•	•
300	110 - 150	1240	•	•	•		
	TSP	140	30 - 90	490		•	
		160	35 - 90	540		•	
		180	40 - 90	590		•	
		200	50 - 90	640		•	
		220	60 - 90	690		•	
		240	60 - 130	740		•	
		260	70 - 130	790		•	
		280	80 - 150	840		•	
300	90 - 150	890		•			
	LFG	240	70 - 130	795		•	
		260	70 - 130	825		•	
		280	80 - 130	880		•	
		300	100 - 150	915		•	
	TFB	120	30 - 90	505		•	
		140	40 - 90	550		•	
		150	40 - 90	600		•	
		160	50 - 90	610		•	
		180	50 - 90	650		•	
		200	50 - 90	705		•	
		220	60 - 90	760		•	
		240	60 - 130	805		•	
		260	60 - 130	860		•	
		280	80 - 130	905		•	
300	100 - 130	930		•			
	TMU	165	50 - 90	665		•	
		185	60 - 90	695		•	
		210	70 - 130	760		•	
		230	80 - 130	820		•	
		250	80 - 130	900		•	
	TMS	140	60 - 110	785		•	
		205	70 - 130	975		•	
		8	90 - 150	1110		•	
	TMS-PRO	155	50 - 150	880		•	
		185	60 - 150	1020		•	
		205	70 - 150	1130		•	
		230	80 - 150	1210		•	
		260	90 - 150	1350		•	
	TSF	200	70 - 150	865		•	
		230	80 - 150	945		•	
		270	80 - 150	1055		•	
		310	110 - 150	1190		•	

MACCHINE MACHINES		LARGHEZZA DI LAVORO WORKING WIDTH	POTENZA TRATTORE TRACTOR POWER	PESO WEIGHT	ATTACCO AL TRATTORE LINKAGE TO THE LIFTER		
Modello Model		cm	HP	kg	Frontale Front	Posteriore Rear	Reversibile Reversible
	ZSF-PRO	120	35 - 70	750		•	
		180	50 - 130	890		•	
		200	60 - 130	955		•	
		230	70 - 130	1055		•	
		250	80 - 150	1135		•	
		280	80 - 150	1240		•	
		310	100 - 150	1380		•	
	ZTS	180	50 - 130	890		•	
		200	60 - 130	955		•	
		230	70 - 130	1055		•	
		310	100 - 150	1380		•	
	ZTS-DT	320	90 - 210	1520		•	
	ZTS-MEGA	460	120 - 180	2400		•	
	ZTS TWIN	460	100 - 280	2700		•	
		620	120 - 280	3100		•	
	TRE-PRO	210	70 - 130	1045		•	
		230	80 - 130	1095		•	
		250	90 - 130	1145		•	
	TRL	130	25 - 60	230	•	•	•
		150	30 - 60	240	•	•	•
		170	35 - 60	290	•	•	•
		190	35 - 80	310	•	•	•
	TFM-R	130	30 - 60	340	•	•	•
		150	35 - 60	350	•	•	•
		170	40 - 60	400	•	•	•
		190	40 - 80	430	•	•	•
	TRV-PRO	160	40 - 70	445	•	•	•
		190	50 - 70	525	•	•	•
		225	70 - 100	590	•	•	•
		250	70 - 100	650	•	•	•
	TRG	100	30 - 60	470	•	•	•
		120	30 - 60	525	•	•	•
		140	35 - 60	550	•	•	•
		160	40 - 90	635	•	•	•
		180	50 - 90	675	•	•	•
		200	50 - 90	720	•	•	•
		220	60 - 90	780	•	•	•
	RFG	240	70 - 130	905	•	•	•
		260	70 - 130	935	•	•	•
		280	80 - 130	990	•	•	•
		300	90 - 130	1025	•	•	•

MACCHINE MACHINES		LARGHEZZA DI LAVORO WORKING WIDTH	POTENZA TRATTORE TRACTOR POWER	PESO WEIGHT	ATTACCO AL TRATTORE LINKAGE TO THE LIFTER		
Modello Model		cm	HP	kg	Frontale Front	Posteriore Rear	Reversibile Reversible
	TRP	165	50 - 120	750	•	•	•
		185	50 - 120	790	•	•	•
		210	60 - 120	875	•	•	•
		230	60 - 120	930	•	•	•
		250	70 - 130	1050	•	•	•
		280	80 - 130	1150	•	•	•
	TMR	140	50 - 110	860	•	•	•
		260	90 - 130	1170	•	•	•
	TMR-PRO	155	50 - 150	945	•	•	•
		185	60 - 150	1065	•	•	•
		205	70 - 150	1149	•	•	•
		230	80 - 150	1230	•	•	•
		260	90 - 150	1370	•	•	•
	TCK	100	50 - 100	450		•	
		130	60 - 120	650		•	
		150	70 - 120	750		•	
		180	80 - 120	850		•	
		210	90 - 120	950		•	
	TLK TLK-PRO	130	70 - 130	810	•	•	•
		155	70 - 130	1050	•	•	•
		180	73 - 130	1150	•	•	•
	TMK TMK-PRO	155	90 - 150		•	•	•
		180	90 - 150		•	•	•
		210	100 - 150		•	•	•
	TPK	180	120 - 180	1750	•		•
		210	120 - 200	1950	•		•
		240	130 - 200	2100	•		•
	TLP	165	50 - 100	768		•	•
		185	60 - 100	825		•	•
		210	80 - 130	885		•	•
	TMP	155	50 - 130	945		•	•
		185	60 - 130	1015		•	•
		205	70 - 130	1100		•	•
		230	80 - 130	1190		•	•
	TM	120	60 - 120	865	•	•	•
		140	90 - 120	1115	•	•	•
		160	90 - 120	1170	•	•	•
		180	100 - 160	1230	•	•	•
		200	100 - 160	1270	•	•	•
		225	120 - 160	1330	•	•	•

CAMPI DI IMPIEGO AREAS OF APPLICATION									DIAMETRO SARMENTI PRUNING DIAMETER
Erba e campo aperto <i>Grass and open field</i>	Vigneto, frutteto e oliveto <i>Vineyard orchard and olive grove</i>	Stocchi <i>Maize stalks</i>	Argini <i>Embankments</i>	Forestale <i>Forestry</i>	Coltelli <i>Blades</i>	Mazze <i>Hammers</i>	Martelli <i>Hammers</i>	Dente Widia <i>Utensils Widia</i>	Ø cm max.
	•				•	•			8
	•				•	•			8
	•				•	•			8
	•				•	•			8
	•				•	•			8
	•				•	•			8
	•					•			8 - 10
	•					•			8 - 10
	•					•			8 - 10
	•					•			8 - 10
	•					•			8 - 10
	•					•			8 - 10
	•					•			6
	•					•			6
	•					•			6
	•					•			6
	•					•			6
	•						•		8 - 10
	•						•		8 - 10
	•						•		8 - 10
	•						•		10 - 12
	•						•		10 - 12
	•						•		10 - 12
	•						•		12 - 15
	•						•		12 - 15
	•						•		12 - 15
	•					•			8 - 10
	•					•			8 - 10
	•					•			8 - 10
	•					•			10 - 12
	•					•			10 - 12
	•					•			10 - 12
	•					•			10 - 12
	•			•		•			
	•			•		•			
	•			•		•			
	•			•		•			
	•			•		•			
	•			•		•			

MACCHINE MACHINES		LARGHEZZA DI LAVORO	POTENZA TRATTORE	PESO	ATTACCO AL TRATTORE		
		WORKING WIDTH	TRACTOR POWER	WEIGHT	LINKAGE TO THE LIFTER		
Modello Model		cm	HP	kg	Frontale Front	Posteriore Rear	Reversibile Reversible
	TL	120	60 - 120	850	•	•	•
		140	90 - 120	985	•	•	•
		160	90 - 120	1055	•	•	•
		180	100 - 160	1145	•	•	•
		200	100 - 160	1240	•	•	•
		225	120 - 160	1285	•	•	•
	TF/DT Special	210	130 - 260	2680		•	•
		250	130 - 260	2880		•	•
	TN/DT Special	210	130 - 260	2480		•	•
		250	130 - 260	2650		•	•
	TMJ	120	25-35	295		•	
		140	25-35	310		•	
	TMO	130	35-70	360		•	
		150	35-70	390		•	
		170	35-70	410		•	
	TMO-SE	130	35-70	360		•	
		150	35-70	390		•	
		170	35-70	410		•	
	TMC	130	50 - 100	610		•	
		160	60 - 100	640		•	
		190	70 - 120	690		•	
		225	90 - 150	760		•	
	TMH	130	60-100	630		•	
		160	60-100	680		•	
		190	60-100	710		•	
		225	60-100	790		•	
	TMH-PRO	140	70-120	680		•	
		160	70-120	735		•	
		180	70-120	790		•	
		200	70-120	820		•	
		220	70-120	840		•	
	TMA-S	210	100-150	1095		•	
		230	100-150	1130		•	
		250	100-150	1200		•	
	TPE	200	90 - 150	1100		•	
		220	100 - 150	1170		•	

CAMPI DI IMPIEGO AREAS OF APPLICATION									DIAMETRO SARMENTI PRUNING DIAMETER
Erba e campo aperto <i>Grass and open field</i>	Vigneto, frutteto e oliveto <i>Vineyard orchard and olive grove</i>	Stocchi <i>Maize stalks</i>	Argini <i>Embankments</i>	Forestale <i>Forestry</i>	Coltelli <i>Blades</i>	Mazze <i>Hammers</i>	Martelli <i>Hammers</i>	Dente Widia <i>Utensils Widia</i>	Ø cm max.
	•			•				•	
	•			•				•	
	•			•				•	
	•			•				•	
	•			•				•	
	•			•				•	
				•		•			
				•		•			
				•				•	
				•				•	
•			•		•	•			
•			•		•	•			
•			•		•	•			3 - 4
•			•		•	•			3 - 4
•			•		•	•			3 - 4
•			•		•	•			3 - 4
•			•		•	•			3 - 4
•			•		•	•			3 - 4
•			•		•	•			5 - 6
•			•		•	•			5 - 6
•			•		•	•			5 - 6
•			•		•	•			5 - 6
•			•		•	•			5 - 6
•			•		•	•			5 - 6
•			•		•	•			5 - 6
•			•		•	•			5 - 6
•			•		•	•			6
•			•		•	•			6
•			•		•	•			6
•			•		•	•			6
•			•		•	•			6
•			•		•	•			6 - 8
•			•		•	•			6 - 8
•			•		•	•			6 - 8
•			•		•	•			6 - 8
•			•		•	•			6 - 8

Impiego **Use** **Verwendung** **Uso** **Utilisation**

Questo modello è indicato per la trinciatura di erba o residui di potatura, nelle coltivazioni ortofrutticole, nei vigneti, nei vivai, e in tutte le piantagioni in genere. Si adatta a qualsiasi tipo di terreno, pianeggiante o collinare, e non richiede particolare manutenzione. Può essere applicato a motocoltivatori e trattorini fino a 25 HP di potenza.

The TSM knife mulcher is ideal for mulching grass and pruning waste in fruit and vegetable gardens, vineyards, plant nurseries, and crops in general. It adapts easily to all kinds of terrain, flat or sloping, and does not require any special maintenance. The TSM mulcher can be mounted on cultivators and garden tractors of up to 25 HP.

Das TSM Mulchgerät mit Y-Messern ist ideal zum Mulchen von Gras und Schnittresten in Obst- und Gemüseärten, Weinbergen, Baumschulen und Nutzpflanzen im Allgemeinen. Es passt sich leicht an alle Arten von Gelände an, egal ob flach oder geneigt. Das TSM Mulchgerät kann auf Einachser und Gartentraktoren mit bis zu 25 HP montiert werden.

Este modelo es indicado para la trituración de hierba y restos de poda, en cultivos hortofrutícolas, viñedos, viveros y en todas las plantaciones en general. Se adapta a cualquier tipo de suelo, en plano o en colina, y no requiere un mantenimiento particular. Puede ser aplicada en motocultivadores y tractores hasta 25 HP de potencia.

Ce modèle est indiqué pour le broyage d'herbe ou de déchets d'élagage, dans les cultures maraîchères, les vignes, les pépinières et toutes les plantations en général. Il s'adapte à tous les types de terrains, plats ou en pente, et ne demande pas d'entretien particulier. Il peut être appliqué sur des motoculteurs et des tracteurs jusqu'à 25 HP de puissance.

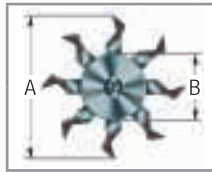
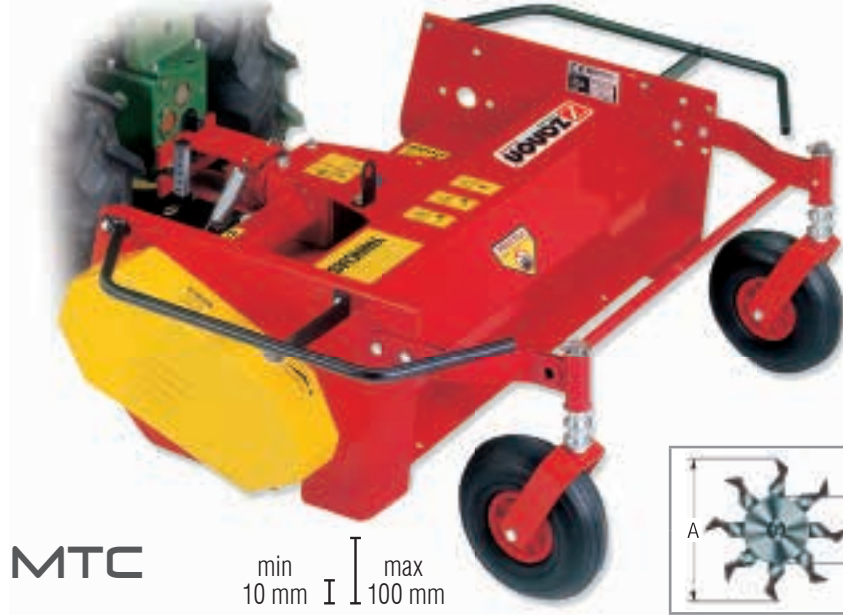

Ø A	280 mm
Ø B	60 mm

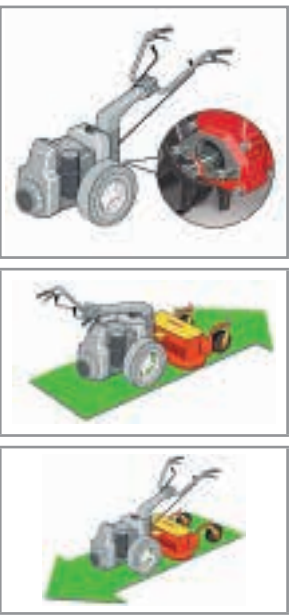
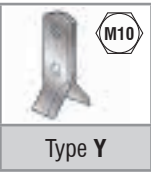



SCAN ME!



















mod.	cod. dx	cod. sx	cm	HP	rpm/min	nr (type)	cm	kg	nr
TSM 600	1002050 (ant.)	1002052 (ant.)	62	7 - 11	800/1000	1 (BX 36 1/2)	96×96×40	88	18
TSM 900	1002051 (ant.)	1002053 (ant.)	92	12 - 18	800/1000	2 (BX 36 1/2)	126×96×40	104	28
TSM 1100	1002264 (ant.)	1002265 (ant.)	110	14 - 25	800/1000	2 (BX 36 1/2)	144×96×40	120	34

Versione anteriore - Front version - Front-Version - Versión frontal - Version avant

mod.	cod. dx	cod. sx	cm	HP	rpm/min	nr (type)	cm	kg	nr
TSM 600	1002048 (post.)	1002054 (post.)	62	7 - 11	800/1000	1 (BX 36 1/2)	96×96×40	88	18
TSM 900	1002049 (post.)	1002055 (post.)	92	12 - 18	800/1000	2 (BX 36 1/2)	126×96×40	104	28
TSM 1100	1002266 (post.)	1002267 (post.)	110	14 - 25	800/1000	2 (BX 36 1/2)	144×96×40	120	34

Versione posteriore - Rear version - Hintere-Version - Versión trasera - Version arrière

Per la TSM da applicare al motocoltivatore specificare il modello.

If the TSM mulcher is to be attached to a cultivator, please state the model.

Bei den TSM-Versionen für Anbau an Einachsschlepper bitte das Modell angeben.

Para las trituradora de sarmientos TSM para motocultivador especificar el modelo.

Pour les broyeur à fléaux TSM à appliquer au motoculteur, préciser le modèle.

Di serie	Standard equipment	Serienmässig	Estándar	De série
<ul style="list-style-type: none"> Rotore con sistema di taglio lineare Coltelli in acciaio fissati con viti autobloccanti Trasmissione a cinghie trapezoidali con tendicinghia regolabile Attacco al motocoltivatore snodabile e registrabile con ruota libera e bullone di sicurezza Ruote anteriori registrabili Gomma di protezione 	<ul style="list-style-type: none"> Rotor with linear cutting system Steel knives secured by self-locking bolts V-belt drive with tension adjustment Adjustable, pivoting cultivator attachment with freewheel and safety bolt Adjustable front wheels Protection rubber 	<ul style="list-style-type: none"> Rotor mit linear Schnittsystem Keilriemnantrieb mit einstellbarem Riemenspanner Verstellbarer Gelenkanschluss an die Motorhackmaschine, mit Freilauf und Sicherheitsschraube Stahlmesser, mit selbstsichernden Schrauben befestigt 2 einstellbare Vorderräder Heck- und Frontschutzgummi 	<ul style="list-style-type: none"> Rotor con sistema de corte lineal Cuchillas de acero fijadas con tornillos de seguridad Transmisión por correas trapezoidales con tensor de correa regulable Enganche al motocultivador articulado y ajustable con rueda libre y perno de seguridad Ruedas delanteras regulables Protección de goma 	<ul style="list-style-type: none"> Rotor avec système de coupe linéaire Fléaux en acier fixés par des vis autobloquantes Transmission à courroies trapézoïdales avec tendeur de courroie réglable Raccord au motoculteur articulé et réglable avec roue libre et boulon de cisaillement Roues antérieures réglables Protection en caoutchouc

TSM	MULCHER FOR TWO-WHEEL TRACTORS AND GARDEN TRACTORS
TSM	MULCHGERÄT FÜR KLEINTRAKTOREN UND EINACHSER
TSM	TRITURADORA DE SARMIENTOS PARA MOTOCULTIVADOR Y TRACTOR
TSM	BROYEUR À FLÉAUX POUR MOTOCULTEUR ET MICRO-TRACTEURS

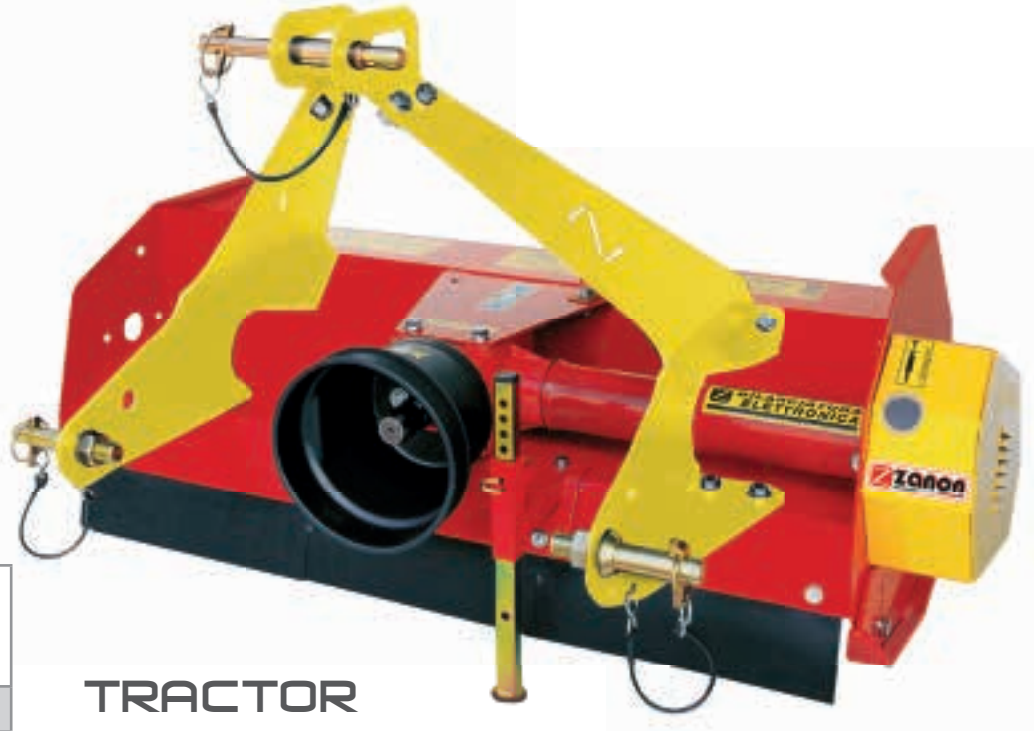
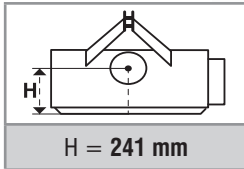
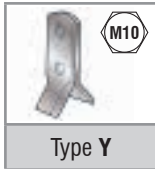
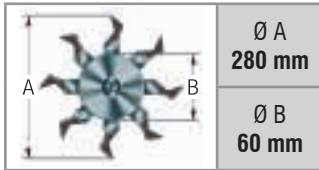

TSM MONOLAMA

TRACTOR

mod.	cod. dx / sx	cm	HP	rpm/min	type	nr (type)	cm	kg	nr
TSM 900 T	1002260 / 61	92	12 - 18	800/1000	T-20	2 (BX 36 ½)	106×88×69	110	28
TSM 1100 T	1002262 / 63	110	14 - 25	800/1000	T-20	2 (BX 36 ½)	125×88×69	125	34

Versione per trattore - Tractor version - Traktorversion - Versión tractor - Version tracteur

Per la TSM da trattorino specificare il verso di rotazione della PDF.

If the TSM mulcher is to be attached to a garden tractor, please state the direction of rotation of the PTO.

Bei den TSM-Versionen für Kleintraktoren bitte den Drehsinn der Zapfwelle angeben.

Para las trituradora de sarmientos TSM para tractor especificar el sentido de rotación de la Toma de Fuerza.

Pour les broyeur à fléaux TSM destinés à un tracteur, préciser le sens de rotation de la PDF.

cod.	Ricambi	Spare parts	Ersatzteile	Recambios	Pièces de rechange
5354001	Cinghia BX-36½	Cug belt BX-36½	Keilriemen BX-36½	Correa BX-36½	Courroie BX-36½
5315007	Vite M10 per utensile	M10 screw for tool	M10 Schraube für Werkzeug	Tornillo M10 para herramienta	Vis M10 pour outil
5323015	Dado M10 per utensile	M10 nut for tool	M10 Mutter für Werkzeug	Tuerca M10 para herramienta	Ecrou M10 pour outil
3350012	Coltello "Y"	Y blade	Y Messer	Cuchilla "Y"	Couteau "Y"
5130018	Cardano T-20	Joint T-20	Gelenkwelle T-20	Cardan T-20	Cardan T-20
2020023	Scatola trasmissione dx	Gear box rh	Getriebe R	Caja de engranajes dcha	Boîtier de transmission droite
2020026	Scatola trasmissione sx	Gear box lf	Getriebe L	Caja de engranajes izq.	Boîtier de transmission gauche
5400012	Protez. ant. in gomma mod.600	Front protection mod.600	Frontschutz mod.600	Proteccion frontal en goma mod.600	Protection arrière mod.600
5400013	Protez. ant. in gomma mod.900	Front protection mod.900	Frontschutz mod.900	Proteccion frontal en gomamod.900	Protection arrière mod.900
5400210	Protez. ant. in gomma mod.1100	Front protection mod.1100	Frontschutz mod.1100	Proteccion frontal en gomamod.1100	Protection arrière mod.1100
(*)	Attacco P.D.F.	P.T.O. Attachment	Anschluss	Acoplamiento T.D.F. en fundición	Attelage de P.D.F. en fonte
(**)	Bussola innesto P.D.F.	P.T.O. Engagement bushing	Kompaß das propfen	Casquillo acoplamiento T.D.F.	Bague abre d'enclenchement P.D.F.

(*) (**) codici variabili a seconda del modello | varying codes according to the model | Unterschiedliche Codes je nach modell | códigos variables según el modelo | codes variables d'après le modèle



Coltelli in acciaio
Steel blades
Stahlmesser
Cuchillas de acero
Couteaux en acier

Impiego **Use** **Verwendung** **Uso** **Utilisation**

La nuova trinciaerba-arieggiatore polivalente può essere impiegata per lavori di trinciatura di erba e arbusti o, più semplicemente, per arieggiare il terreno e consentire così un'adeguata manutenzione del manto erboso.

This new, multi-purpose mulcher and aerator can be used for mulching grass and shrubs or simply to aerate the soil and help maintain a healthy lawn.

Das TSM Off-Road Mulchgerät kann zum Mulchen von Gras und Sträuchern oder einfach zur Belüftung des Bodens und zur Erhaltung eines gesunden Rasens eingesetzt werden.

La nueva trituradora de hierba-esca-rificadora polivalente puede emplearse para labores de trituración de hierba y arbustos o, sencillamente, para oxigenar el suelo y permitir su adecuado mantenimiento del césped.

Le nouveau broyeur-aérateur polyvalent peut être utilisé pour le broyage d'herbe et d'arbustes ou, plus simplement, pour aérer le sol et permettre ainsi un entretien adéquat du gazon.



POWERED by **HONDA**



Arresto d'emergenza
Emergency stop
Nothalt
Parada de emergencia
Arrêt d'urgence



Coltelli in acciaio
Steel blades
Stahlmesser
Cuchillas de acero
Couteaux en acier



SCAN ME!

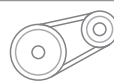

mod.	cod.	HP	nr (type)	cm	kg
TSM OFF-ROAD 1000	1002623	13 (HONDA GX 390)	2 (AX 37)	155×89×75	155
TSM OFF-ROAD 1250	1002624	16 (VANGUARD GROSS)	2 (AX 37)	180×88×86	170

È ideata per l'applicazione posteriore su QUAD, Rider e Atv.

Grazie ad un semplice "manettino" è possibile regolare l'altezza di taglio.

È possibile utilizzarla in spazi pubblici, come prati e aree sportive, grazie alle dotazioni antinfortunistiche delle quali è munito.

Nota: Non può essere trainata su strada.

It is designed to be towed behind a quad, ride-on garden tractor or ATV.

Cutting height can be adjusted easily by means of a handle.

Various safety devices allow this mulcher to be used in public areas like parks and sports grounds.

Note: This product cannot be towed on a public road.

Das TSM Off-Road Mulchgerät ist dafür ausgelegt, hinter einem Quad, Gartentraktor oder ATV gezogen zu werden. Die Schnitthöhe lässt sich mit einem Handgriff leicht einstellen. Verschiedene Sicherheitsvorrichtungen ermöglichen den Einsatz dieses Mulchgeräts in öffentlichen Bereichen wie Parks und Sportplätzen.

Hinweis: Dieses Produkt kann nicht auf einer öffentlichen Straße gezogen werden.

Ha sido diseñada para ser montada detrás de QUAD, Tractores compactos y Cuatrimotos.

Gracias a una "palanca" es posible regular la altura de corte. Es posible utilizarla en espacios públicos, como prados y áreas deportivas, gracias a los equipos de seguridad que monta.

Nota: No puede ser remolcada por la vía pública.

Il est conçu pour l'application arrière sur quad, tondeuse frontale et VTT. Une simple manette permet de régler la hauteur de coupe. Ce broyeur peut être utilisé dans les espaces publics, tels que les pelouses des parcs et zones sportives, grâce aux équipements de protection contre les accidents dont il est équipé.

Note: Il ne peut pas être traîné pour la circulation sur route.

Di serie	Standard equipment	Serienmässig	Estándar	De série
<ul style="list-style-type: none"> Rotore con sistema di taglio elicoidale Tendinghia registrabile Frizione centrifuga Autostop in caso di emergenza al posto di guida Gancio traino a standard europeo Gomma di protezione Protezioni antinfortunistiche conformi alla normativa CE 	<ul style="list-style-type: none"> Rotor with helical cutting system Adjustable belt tensioner Centrifugal clutch Automatic emergency stop accessible from driving position European standard towing hitch Protection rubber Protective equipment as per EC safety rules 	<ul style="list-style-type: none"> Spiralrotor Einstellbarer Riemenpanner Fliehkraftkupplung "Trampen" im Notfall mit einer Fahrt Europäische Norm Anhängerkupplung Heck- und Frontschutzgummi Unfallschutz nach EU-Vorschriften 	<ul style="list-style-type: none"> Rotor con sistema de corte helicoidal Tensor de correa ajustable Embrague centrifugo Parada automática en caso de emergencia en el puesto de conducción Gancho de remolque según estándar europeo Protección de goma Protecciones de seguridad de acuerdo con la norma CE 	<ul style="list-style-type: none"> Rotor avec système de coupe hélicoïdal Tendeur de courroie réglable Embrayage centrifuge Arrêt automatique en cas d'urgence au poste de conduite Crochet d'attelage aux normes européennes Protection en caoutchouc Protections contre les accidents aux normes CE

TSM OFF-ROAD	MULCHER FOR QUADS, RIDE-ON GARDEN TRACTORS AND ATV
TSM OFF-ROAD	MULCHGERÄTE FÜR QUAD, RIDER UND ATV
TSM OFF-ROAD	TRITURADORA DE SARMIENTOS PARA QUAD, TRACTOR Y CUATRIMOTO
TSM OFF-ROAD	BROYEUR À FLÉAUX POUR MOTOCULTEUR ET MICRO-TRACTEURS



ORIGINAL MADE IN ITALY

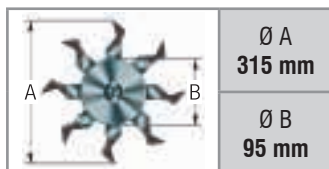

Ø A
315 mm
Ø B
95 mm

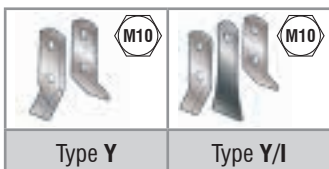

Type Y

Type Y/I



Sistema di taglio elicoidale
Helical cutting system
Spiralrotor
Sistema de corte helicoidal
Système de coupe hélicoïdal



MOVEMENT MACHINE

MOD

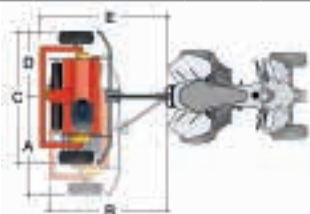

	WORKING WIDTH	Standard	On request
--	----------------------	----------	------------

MOD



mod.	A cm	B cm	C cm	D cm	E cm
TSM OFF-ROAD 1000	180	180	155	35	200
TSM OFF-ROAD 1250	205	180	180	35	200

mod.	cm	nr	nr
TSM OFF-ROAD 1000	100	40	20
TSM OFF-ROAD 1250	125	52	26

cod.	A richiesta	On request	Auf Anfrage	Opcionales	Sur demande
5350141	Coltello "I" vers. "arieggiatore"	Straight aeration "I" blade	Vertikutierer "I" Messer	Cuchilla "I" vers. "escarificador"	Couteau "I" vers. "scarificateur"

cod	Ricambi	Spare parts	Ersatzteile	Recambios	Pièces de rechange
5354077	Cinghia AX-37	Cug belt AX-37	Keilriemen AX-37	Correa AX-37	Courroie AX-37
5315007	Vite M10 per utensile	M10 screw for tool	M10 Schraube für Werkzeug	Tomillo M10 para herramienta	Vis M10 pour outil
5323015	Dado M10 per utensile	M10 nut for tool	M10 Mutter für Werkzeug	Tuerca M10 para herramienta	Ecrou M10 pour outil
5350059	Coltello "Y"	"Y" blade	"Y" Messer	Cuchilla "Y"	Couteau "Y"
5023077	Motore HONDA 13 HP	Motor HONDA 13 HP	Motor HONDA 13 HP	Motor HONDA 13 HP	Moteur HONDA 13 HP
5023106	Motore VANGUARD GROSS 16 HP	Motor VANGUARD GROSS 16 HP	Motor VANGUARD GROSS 16 HP	Motor VANGUARD GROSS 16 HP	Moteur VANGUARD GROSS 16 HP



Doppia regolazione di taglio
Two cutting setting
Doppel arbeits Einstellung
Double regulación de corte
Double régulation de coupe



TSM OFF-ROAD

Impiego Use Verwendung Uso Utilisation

Le trincia RYDER sono adattabili ad una grande varietà di trattorini frontali (JD, Kubota, Iseki, Gianni Ferrari,...). Si possono equipaggiare indifferentemente di coltelli a Y, di mazze o di coltelli per la versione aereggiatore.

The RYDER mulcher adapts easily to a wide range of garden tractors, including JD, Kubota, Iseki, Gianni Ferrari, and many other makes besides. The rotor can be fitted with Y blades, hammers or aerating blades.

Das RYDER Mulchgerät lässt sich problemlos an eine Vielzahl von Traktoren mit Frontanbau anpassen, wie John Deere, Kubota, Iseki, Gianni Ferrari und viele andere mehr. Der Rotor kann mit Y-Messern, Hämmern oder Belüftungsmessern ausgestattet werden.

La trituradora de hierba RYDER se adapta fácilmente a una enorme variedad de minitractores frontales, tales como JD, Kubota, Iseki, Gianni Ferrari y muchos más. Se puede equipar con cuchillas en Y, martillos o cuchillas para escarificar.

Le broyeur RYDER est facilement adaptable à un grand nombre de tondeuses frontales, des marques JD, Kubota, Iseki, Gianni Ferrari ainsi que de nombreux autres modèles. Il peut être équipé de fléaux en Y, mar-teaux ou fléaux scarificateurs.

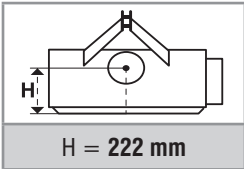

mod.	cod.	cod.	HP	rpm/min	type	nr (type)	cm	kg
RYDER 1400 Kubota	1002720	1002719	15 - 45	2000	T-20	4 (BX 37)	160×110×50	210
RYDER 1600 Kubota	1002713	1002712	15 - 45	2000	T-20	4 (BX 37)	180×110×50	250
RYDER 1400 Iseki	1002718	1002717	15 - 45	2000	T-20	4 (BX 36 1/4)	160×110×50	210
RYDER 1600 Iseki	1002711	1002710	15 - 45	2000	T-20	4 (BX 36 1/4)	180×110×50	250
RYDER 1400 John Deere	1002715	1002716	15 - 45	2000	T-20	4 (BX 36 1/4)	160×110×50	210
RYDER 1600 John Deere	1002709	1002708	15 - 45	2000	T-20	4 (BX 36 1/4)	180×110×50	250
RYDER 1400 G. Ferrari	1002722	1002721	15 - 45	2000	T-20	4 (BX 35 3/4)	160×110×50	210
RYDER 1600 G. Ferrari	1002724	1002723	15 - 45	2000	T-20	4 (BX 35 3/4)	180×110×50	250
RYDER 1400 Shibaura	1003102	1003077	15 - 45	2000	T-20	4 (BX 36 1/4)	160×110×50	210
RYDER 1600 Shibaura	1003103	1003078	15 - 45	2000	T-20	4 (BX 36 1/4)	180×110×50	250
RYDER 1400 Grillo	1003083	1003075	15 - 45	2000	T-20	4 (BX 35 3/4)	160×110×50	210
RYDER 1600 Grillo	1003084	1003076	15 - 45	2000	T-20	4 (BX 35 3/4)	180×110×50	250

Specificare il mod. di trattorino Specify mod. of garden tractor Modell des Traktors angeben Especificar el modelo de tractor Précisez le modèle de tracteur



Regolazione altezza taglio
Cutting height adjustment
Schnitthöhe
Ajuste de altura de corte
Réglage hauteur de coupe



Regolazione altezza ruota
Height adjustment wheels
Höhenverstellung Räder
Ruedas de ajuste de altura
Molettes de réglage de la hauteur

RYDER	FRONT MOWER FOR COMPACT TRACTORS
RYDER	SCHLEGELMULCHER FRONTANBAU FÜR RASENTRAKTOR
RYDER	TRITURADORA DE HIERBA PARA MINITRACTORES FRONTALES
RYDER	BROYEUR POUR TONDEUSES FRONTALES

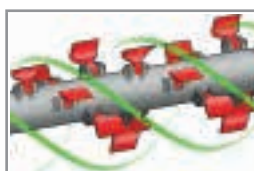
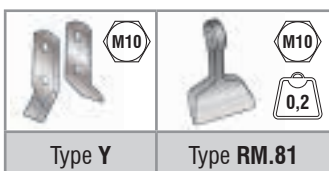
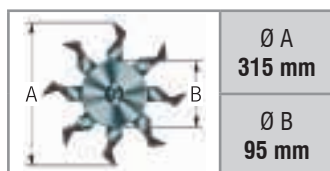

Sistema di taglio elicoidale
Helical cutting system
Spiralrotor
Sistema de corte helicoidal
Système de coupe hélicoïdal

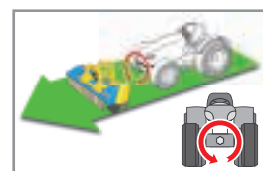

MOD	MOVEMENT MACHINE		WORKING WIDTH		Standard		On request	
	mod.	cm	cm	nr	nr	nr	nr	
RYDER 1400	80	80	140	88	44	44	44	
RYDER 1600	90	90	160	100	50	50	50	

Di serie	Standard equipment	Serienmässig	Estándar	De série
<ul style="list-style-type: none"> Scatola di trasmissione con ruota libera PTO 1 3/8" Z6 Cardano Kit ruote anteriori in gomma pivotanti Rotore con sistema di taglio elicoidale Castello fisso Angolare rompitore Slitte d'appoggio fisse Pattino slitta in lamiera antiusura Tendinghia registrabile Rullo ozioso posteriore regolabile in altezza (114 mm) Raschiafango per pulizia rullo ozioso Scarico anteriore rullo ozioso Protezione anteriore in gomma Protezione posteriore in gomma Protezioni antinfortunistiche conformi alla normativa CE 	<ul style="list-style-type: none"> Gearbox with freewheel clutch PTO 1 3/8" Z6 PTO drive shaft Front pivoting rubber wheels kit Rotor with helical cutting system 3-point linkage fixed Corner reinforcement for shredding material Fixed skids Skids protections in anti-wearing plate Belt adjuster Rear levelling roller height adjustable (114 mm) Scraper for rear levelling roller Discharge of the material over the levelling roller Front protection with rubber Rear protection with rubber Protective equipment as per EC safety rules 	<ul style="list-style-type: none"> Getriebe mit integriertem Freilauf PTO 1 3/8" Z6 Gelenkwelle Satz schwenkbare Gummiräder vorne Spiralrotor Anbaubock fest Eckenverstärkung für Zerkleinerungsmaterial Stützkufen fest Verschleißschutzplatten für Stützkufen Riemenspannung Hintere Stützwalze höhenverstellbar (114 mm) Walzenabstreifer Entladung des Materials über die Walze Frontschutz mit Gummileiste Hinterer Gummischutz Unfallschutz nach EU-Vorschriften 	<ul style="list-style-type: none"> Caja de engranajes con rueda libre TDF 1 3/8" Z6 Transmisión cardanica Kit de ruedas delanteras, en goma, pivotantes Rotor con sistema de corte helicoidal Arco de tercer punto fijo Rompedor angular Patines de apoyo fijos Suplemento patín en acero anti desgaste Tensor de correas regulable Rodillo nivelador trasero (114 mm), con regulación en altura Limpiador montado en el rodillo nivelador trasero Descarga anterior al rodillo nivelador Protección frontal en goma Protección posterior en goma Protecciones de seguridad de acuerdo con la norma CE 	<ul style="list-style-type: none"> Boîtier de transmission avec roue libre PDF 1 3/8" Z6 Cardan Kit roues antérieures pivotantes en caoutchouc Rotor avec système de coupe hélicoïdal Châssis fixe Barre brisante Patins d'appui fixes Plaques anti-usure Tendeur de courroie réglable Rouleau d'appui arrière réglable en hauteur (114 mm) Racleur pour le rouleau d'appui Ejection devant le rouleau d'appui Protection avant en caoutchouc Protection arrière en caoutchouc Protections contre les accidents aux normes CE

cod.	A richiesta	On request	Auf Anfrage	Opcionales	Sur demande
5350141	Coltello "I" vers. "arieggiatore"	Straight aeration "I" blade	Vertikutierer "I" Messer	Cuchilla "I" vers. "escarificador"	Couteau "I" vers. "scarificateur"
5223355	Lamiera antiusura mod. 1400	Wear plate mod. 1400	Verschleißplatte mod. 1400	Placa anti desgaste mod. 1400	Plaque d'usure mod. 1400
5223356	Lamiera antiusura mod. 1600	Wear plate mod. 1600	Verschleißplatte mod. 1600	Placa anti desgaste mod. 1600	Plaque d'usure mod. 1600

cod.	Ricambi	Spare parts	Ersatzteile	Recambios	Pièces de rechange
5354100	Cinghia BX 35 3/4	Cug belt BX 35 3/4	Keilriemen BX 35 3/4	Correa BX 35 3/4	Courroie BX 35 3/4
5354099	Cinghia BX 36 1/4	Cug belt BX 36 1/4	Keilriemen BX 36 1/4	Correa BX 36 1/4	Courroie BX 36 1/4
5354080	Cinghia BX 37	Cug belt BX 37	Keilriemen BX 37	Correa BX 37	Courroie BX 37
5315007	Vite M10 per utensile	M10 screw for tool	M10 Schraube für Werkzeug	Tornillo M10 para herramienta	Vis M10 pour outil
5323015	Dado M10 per utensile	M10 nut for tool	M10 Mutter für Werkzeug	Tuerca M10 para herramienta	Ecrou M10 pour outil
5350114	Mazza RM.81	Hammer RM.81	Hammer RM.81	Martillo RM.81	Marteau RM.81
5350059	Coltello "Y"	"Y" blade	"Y" Messer	Cuchilla "Y"	Couteau "Y"



Attacco a 3 punti cat. I
3-point linkage cat. I
Dreipunktanbaubock Kat. I
Enganche de 3 puntos cat. I
Attelage à 3 points cat. I

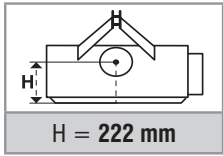

Attacco a 3 punti cat. 0 (attacco rapido a triangolo)
3-point linkage cat. 0 (quick triangle connection)
Dreipunktanbaubock Kat. 0 (Kuppeldreieck)
Enganche de 3 puntos cat. 0 (conexión rápida)
Attelage à 3 points cat. 0 (triangle à connexion rapide)



SCAN ME!



mod.	cat.	cod.	cod.	HP	rpm	dx/sx	type	nr (type)	cm	kg
RYDER TRACTOR 1400	0	--	1002790	30 - 40	1000	dx	T-20	(BX 36 ¼)	160×80×64	260
RYDER TRACTOR 1400	0	--	1002791	30 - 40	1000	sx	T-20	(BX 36 ¼)	160×80×64	260
RYDER TRACTOR 1400	0	--	1002792	30 - 40	2000	dx	T-20	(BX 35 ¾)	160×80×64	260
RYDER TRACTOR 1400	0	--	1002793	30 - 40	2000	sx	T-20	(BX 35 ¾)	160×80×64	260
RYDER TRACTOR 1400	1	--	1002802	30 - 40	1000	dx	T-20	(BX 36 ¼)	160×80×64	260
RYDER TRACTOR 1400	1	--	1002803	30 - 40	1000	sx	T-20	(BX 36 ¼)	160×80×64	260
RYDER TRACTOR 1400	1	--	1002804	30 - 40	2000	dx	T-20	(BX 35 ¾)	160×80×64	260
RYDER TRACTOR 1400	1	--	1002805	30 - 40	2000	sx	T-20	(BX 35 ¾)	160×80×64	260
RYDER TRACTOR 1600	0	--	1002796	30 - 40	1000	dx	T-20	(BX 36 ¼)	180×80×64	290
RYDER TRACTOR 1600	0	--	1002797	30 - 40	1000	sx	T-20	(BX 36 ¼)	180×80×64	290
RYDER TRACTOR 1600	0	--	1002798	30 - 40	2000	dx	T-20	(BX 35 ¾)	180×80×64	290
RYDER TRACTOR 1600	0	--	1002799	30 - 40	2000	sx	T-20	(BX 35 ¾)	180×80×64	290
RYDER TRACTOR 1600	1	1002807	--	30 - 40	1000	dx	T-20	(BX 36 ¼)	180×80×64	290
RYDER TRACTOR 1600	1	--	1002808	30 - 40	1000	dx	T-20	(BX 36 ¼)	180×80×64	290
RYDER TRACTOR 1600	1	--	1002809	30 - 40	1000	sx	T-20	(BX 36 ¼)	180×80×64	290
RYDER TRACTOR 1600	1	--	1002810	30 - 40	2000	dx	T-20	(BX 35 ¾)	180×80×64	290
RYDER TRACTOR 1600	1	--	1002811	30 - 40	2000	sx	T-20	(BX 35 ¾)	180×80×64	290
RYDER TRACTOR 1600	1	1002854	--	30 - 40	2000	sx	T-20	(BX 35 ¾)	180×80×64	290

All'ordine specificare sempre:

To order, always specify:

Bestellen sie immer:

Al ordenar, siempre especificque:

Pour commander spécifiez toujours:

<input checked="" type="checkbox"/> Cat. I 	<input checked="" type="checkbox"/> Cat. 0 	<input checked="" type="checkbox"/>  <input checked="" type="checkbox"/> 	<input checked="" type="checkbox"/> PTO <input checked="" type="checkbox"/> 1000 rpm <input checked="" type="checkbox"/> 2000 rpm	<input checked="" type="checkbox"/>  <input checked="" type="checkbox"/> 
CAT. ATTACHMENT		TOOLS	RPM PTO	ROTATION

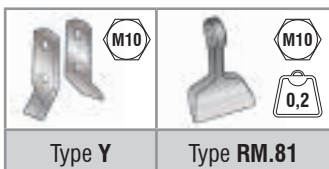
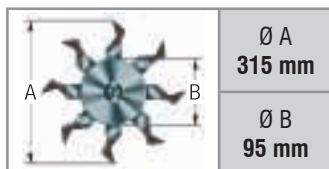

Sistema di taglio elicoidale
Helical cutting system
Spiralrotor
Sistema de corte helicoidal
Système de coupe hélicoïdal

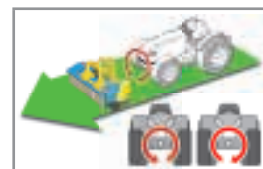

MOD	MOVEMENT MACHINE		WORKING WIDTH	Standard		On request
	mod.	cm	cm	nr	nr	nr
RYDER TRACTOR 1400	80	80	140	88	44	44
RYDER TRACTOR 1600	90	90	160	100	50	50

Di serie	Standard equipment	Serienmässig	Estándar	De série
<ul style="list-style-type: none"> Pattino slitta in lamiera antiusura Cardano Kit ruote anteriori in gomma pivottanti Rotore con sistema di taglio elicoidale Tendicinghia registrabile Rullo ozioso posteriore regolabile in altezza (114 mm) Raschifango per pulizia rullo ozioso Scarico anteriore rullo ozioso Protezione anteriore in gomma Protezione posteriore in gomma Protezioni antinfortunistiche conformi alla normativa CE 	<ul style="list-style-type: none"> Skids protections in anti-wearing plate PTO drive shaft Front pivoting rubber wheels kit Rotor with helical cutting system Belt adjuster Rear levelling roller height adjustable (114 mm) Scraper for rear levelling roller Discharge of the material over the levelling roller Front protection with rubber Rear protection with rubber Protective equipment as per EC safety rules 	<ul style="list-style-type: none"> Verschleißschutzplatten für Stützkufen Gelenkwelle Satz schwenkbare Gummiräder vorne Spiralrotor Riemenspannung Hinterer Stützwalze höhenverstellbar (114 mm) Walzenabstreifer Entladung des Materials über die Walze Frontschutz mit Gummileiste Hinterer Gummischutz Unfallschutz nach EU-Vorschriften 	<ul style="list-style-type: none"> Suplemento patin en acero anti desgaste Transmisión cardanica Kit de ruedas delanteras, en goma, pivotantes Rotor con sistema de corte helicoidal Tensor de correas regulable Rodillo nivelador trasero (114 mm), con regulación en altura Limpiador montado en el rodillo nivelador trasero Descarga anterior al rodillo nivelador Protección frontal en goma Protección posterior en goma Protecciones de seguridad de acuerdo con la norma CE 	<ul style="list-style-type: none"> Plaques anti-usure pour patins Cardan Kit roues antérieures pivotantes en caoutchouc Rotor avec système de coupe hélicoïdal Tendeur de courroie réglable Rouleau d'appui arrière réglable en hauteur (114 mm) Racleur pour le rouleau d'appui Ejection devant le rouleau d'appui Protection antérieures en caoutchouc Protection arrière en caoutchouc Protections contre les accidents aux normes CE

cod.	A richiesta	On request	Auf Anfrage	Opcionales	Sur demande
5350141	Coltello "I" vers. "arieggiatore"	Straight aeration "I" blade	Vertikutierer "I" Messer	Cuchilla "I" vers. "escarificador"	Couteau "I" vers. "scarificateur"
5223355	Lamiera antiusura mod. 1400	Wear plate mod. 1400	Verschleissplatte mod. 1400	Placa anti desgaste mod. 1400	Plaque d'usure mod. 1400
5223356	Lamiera antiusura mod. 1600	Wear plate mod. 1600	Verschleissplatte mod. 1600	Placa anti desgaste mod. 1600	Plaque d'usure mod. 1600

cod.	Ricambi	Spare parts	Ersatzteile	Recambios	Pièces de rechange
5354100	Cinghia BX 35 3/4 - 2000 rpm	Cug belt BX 35 3/4 - 2000 rpm	Keilriemen BX 35 3/4 - 2000 rpm	Correa BX 35 3/4 - 2000 rpm	Courroie BX 35 3/4 - 2000 rpm
5354099	Cinghia BX 36 1/4 - 1000 rpm	Cug belt BX 36 1/4 - 1000 rpm	Keilriemen BX 36 1/4 - 1000 rpm	Correa BX 36 1/4 - 1000 rpm	Courroie BX 36 1/4 - 1000 rpm
5315007	Vite M10 per utensile	M10 screw for tool	M10 Schraube für Werkzeug	Tornillo M10 para herramienta	Vis M10 pour outil
5323015	Dado M10 per utensile	M10 nut for tool	M10 Mutter für Werkzeug	Tuerca M10 para herramienta	Ecrou M10 pour outil
5350114	Mazza RM.81	Hammer RM.81	Hammer RM.81	Martillo RM.81	Marteau RM.81
5350059	Coltello "Y"	"Y" blade	"Y" Messer	Cuchilla "Y"	Couteau "Y"



Regolazione altezza ruota
Height adjustment wheels
Höhenverstellung Räder
Ruedas de ajuste de altura
Molletes de réglage de la hauteur



Regolazione altezza taglio
Cutting height adjustment
Schnitthöhe
Ajuste de altura de corte
Réglage hauteur de coupe



Impiego

La trinciaerba TSS è studiata per essere applicata posteriormente all'attacco a tre punti di trattori a potenza ridotta (dai 12 ai 30 HP). Garantisce un taglio perfetto del manto erboso grazie all'elevato numero di giri del rotore e alle numerose lame a palette. Favorisce, inoltre, una perfetta azione di trinciatura: ottimo risultato su giardini, prati ed aree urbane.

Use

The TSS mulcher is designed for mounting on the three point linkage of low power tractors (12 to 30 HP). It guarantees perfect grass cutting thanks to a high rotor speed and a large number of blades. Its mulching action proves highly effective on lawns, parkland and urban green areas.

Verwendung

Das TSS Mulchegerät ist für den Heckanbau an Kompakttraktoren mit niedriger Leistung (12 bis 30 HP) ausgelegt. Ideal für den privaten Gebrauch zur Rasenreinigung. Garantiert einen perfekten Grasschnitt dank einer hohen Rotordrehzahl und einer großen Anzahl von Hammern.





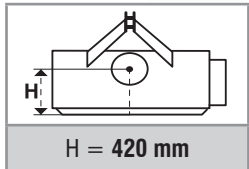

Uso

La trituradora de hierba TSS ha sido estudiada para ser montada detrás del enganche de tres puntos de tractores de baja potencia (de 12 a 30 HP). Por las revoluciones altas del rotor y las numerosas cuchillas acodadas, garantiza un corte perfecto del césped. Asimismo, favorece una perfecta acción de cubrición ("mulching"): un excelente resultado en jardines, parques y zonas urbanas.

Utilisation

Le broyeur d'herbe TSS est conçu pour être appliqué à l'arrière à l'attelage trois points de tracteurs à puissance réduite (de 12 à 30 HP). Il garantit une coupe parfaite du gazon grâce au régime élevé du rotor et aux nombreux fléaux. Il favorise également une parfaite action de broyage: excellent résultat dans les jardins, les pelouses et les espaces verts.

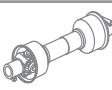
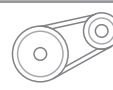

							
mod.	cod.	HP	rpm/min	type	nr (type)	cm	kg
TSS 1000	1002460	12 - 30	540	T-20	2 (BX 39)	113×65×74	105
TSS 1250	1002461	15 - 30	540	T-20	2 (BX 39)	140×65×74	115

Di serie	Standard equipment	Serienmässig	Estándar	De série
<ul style="list-style-type: none"> Scatola di trasmissione con ruota libera PTO 1 3/8" Z6 Rotore con sistema di taglio elicoidale Castello fisso Angolare rompitore Slitte d'appoggio fisse Pattino slitta in lamiera antiusura Tendinghia registrabile Rullo ozioso posteriore regolabile in altezza (114 mm) Raschifango per pulizia rullo ozioso Scarico anteriore rullo ozioso Protezione anteriore in gomma Protezioni antinfortunistiche conformi alla normativa CE 	<ul style="list-style-type: none"> Gearbox with freewheel clutch PTO 1 3/8" Z6 Rotor with helical cutting system 3-point linkage fixed Corner reinforcement for shredding material Fixed skids Skids protections in anti-wearing plate Belt adjuster Rear levelling roller height adjustable (114 mm) Scraper for rear levelling roller Discharge of the material over the levelling roller Front protection with rubber Protective equipment as per EC safety rules 	<ul style="list-style-type: none"> Getriebe mit integriertem Freilauf PTO 1 3/8" Z6 Spiralrotor Anbaubock fest Eckenverstärkung für Zerkleinerungsmaterial Stützkufen fest Verschleißschutzplatten für Stützkufen Riemenspannung Hintere Stützwalze höhenverstellbar (114 mm) Walzenabstreifer Entladung des Materials über die Walze Frontschutz mit Gummileiste Unfallschutz nach EU-Vorschriften 	<ul style="list-style-type: none"> Caja de engranajes con rueda libre TDF 1 3/8" Z6 Rotor con sistema de corte helicoidal Arco de tercer punto fijo Rompedor angular Patines de apoyo fijos Suplemento patín en acero anti desgaste Tensor de correas regulable Rodillo nivelador trasero (114 mm), con regulación en altura Limpiador montado en el rodillo nivelador trasero Descarga anterior al rodillo nivelador Protección frontal en goma Protecciones de seguridad de acuerdo con la norma CE 	<ul style="list-style-type: none"> Boîtier de transmission avec roue libre PDF 1 3/8" Z6 Rotor avec système de coupe hélicoïdal Châssis fixe Barre brisante Patins d'appui fixes Plaques anti-usure Tendeur de courroie réglable Rouleau d'appui arrière réglable en hauteur (114 mm) Racleur pour le rouleau d'appui Ejection devant le rouleau d'appui Protection avant en caoutchouc Protections contre les accidents aux normes CE

TSS MULCHER FOR COMPACT TRACTORS
TSS SCHLEGELMULCHER FÜR KLEINTRAKTOREN
TSS TRITURADORA DE HIERBA PARA TRACTORES PEQUEÑOS
TSS BROYEUR D'HERBE POUR MICRO-TRACTEURS



ORIGINAL MADE IN ITALY

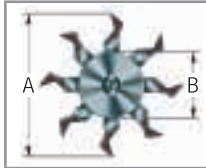

Ø A
280 mm
Ø B
60 mm

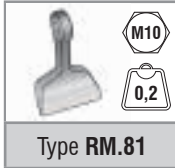

Sistema di taglio elicoidale
Helical cutting system
Spiralrotor
Sistema de corte helicoidal
Système de coupe hélicoïdal



	MOVEMENT MACHINE	
MOD		
mod.	cm	
TSS 1000	59	54
TSS 1250	72	68

	WORKING WIDTH	Standard
	cm	nr
	100	20
	125	26



TSS

cod.	A richiesta	On request	Auf Anfrage	Opcionales	Sur demande
5130018	Cardano T-20	PTO shaft T-20	Gelenkwelle T-20	Cardán T-20	Cardan T-20

cod.	Ricambi	Spare parts	Ersatzteile	Recambios	Pièces de rechange
5354012	Cinghia BX 39	Cug belt BX 39	Keilriemen BX 39	Correa BX 39	Courroie BX 39
5315007	Vite M10 per utensile	M10 screw for tool	M10 Schraube für Werkzeug	Tornillo M10 para herramienta	Vis M10 pour outil
5323015	Dado M10 per utensile	M10 nut for tool	M10 Mutter für Werkzeug	Tuerca M10 para herramienta	Ecrou M10 pour outil
5350114	Mazza RM.81	Hammer RM.81	Hammer RM.81	Martillo RM.81	Marteau RM.81
2020030	Scatola trasmissione TSS	Gear box TSS	Getriebe TSS	Caja de engranajes TSS	Boîtier de transmission TSS



Impiego

La trinciaerba e sarmenti TFL è una macchina studiata per essere applicata a trattori di potenza ridotta (12-40 HP). Si presta in modo ottimale per la triturazione di sarmenti, erba, sterpaglie, paglia, e molto altro.

Use

The TFL mulcher is designed for mounting on low power tractors (12 to 40 HP). It is ideal for mulching twigs, grass, brushwood, hay and more besides.

Verwendung

Das TFL Mulchgerät ist für den Heckanbau an Traktoren mit niedriger Leistung (12 bis 40 HP) ausgelegt. Es eignet sich ideal zum mulchen von Gras, Zweigen und Gestrüpp.

Uso

La trituradora de hierba y sarmientos TFL es una máquina diseñada para su aplicación en tractores de baja potencia (12-40 HP). Es excelente para triturar sarmientos, hierba, malezas, paja y mucho más.

Utilisation

Le broyeur d'herbe et de sarments TFL est une machine conçue pour être appliquée sur des tracteurs de puissance réduite (12-40 HP). Il est particulièrement indiqué pour le broyage de sarments, herbe, broussailles, paille et de nombreux autres végétaux.

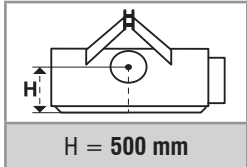

mod.	cod.	cod.	HP	rpm/min	type	nr (type)	cm	kg
TFL 100	1002873	1002872	12 - 40	540/1000	T-40	2 (BX 39)	119×78×80	190
TFL 115	1002879	1002878	12 - 40	540/1000	T-40	2 (BX 39)	130×78×80	205

Versione fissa - Fixed version - Feste Version - Versión fija - Version fixe

mod.	cod.	cod.	min-max	rpm/min	type	nr (type)	cm	kg
TFL 130	1002881	1002880	15 - 40	540/1000	T-40	2 (BX 39)	145×78×80	220
TFL 150	1003004	1003003	20 - 40	540/1000	T-40	2 (BX 39)	167×78×80	235

Versione con spostamento su due posizioni (10 cm) - Version with side shift on two positions (10 cm) - Version mit Seitenverschiebung mit zwei Positionen (10 cm) - Desplazamiento lateral en dos posiciones fijas, centrada o desplazado el arco 10 cm - Version avec déport latéral sur deux positions (10 cm)

Di serie	Standard equipment	Serienmässig	Estándar	De série
<ul style="list-style-type: none"> Scatola di trasmissione con ruota libera PTO 1 3/8" Z6 Rotore con sistema di taglio elicoidale Castello fisso Angolare rompitore Slitte d'appoggio regolabili in altezza Tendinghia registrabile Rullo ozioso posteriore regolabile in altezza (114 mm) Raschifango per pulizia rullo ozioso Scarico anteriore rullo ozioso Cofano apribile (solo per ispezione) Protezione anteriore in gomma Protezione posteriore in gomma Protezioni antinfortunistiche conformi alla normativa CE 	<ul style="list-style-type: none"> Gearbox with freewheel clutch PTO 1 3/8" Z6 Rotor with helical cutting system 3-point linkage fixed Corner reinforcement for shredding material Height-adjustable skids Belt adjuster Rear levelling roller height adjustable (114 mm) Scraper for rear levelling roller Discharge of the material over the levelling roller Opening hood (for inspection only) Front protection with rubber Rear protection with rubber Protective equipment as per EC safety rules 	<ul style="list-style-type: none"> Getriebe mit integriertem Freilauf PTO 1 3/8" Z6 Spiralrotor Anbaubock fest Eckenverstärkung für Zerkleinerungsmaterial Höhenverstellbare Stützkufen Riemenspannung Hintere Stützwalze höhenverstellbar (114 mm) Walzenabstreifer Entladung des Materials über die Walze Heckhaube (darf nur für Wartungsarbeiten geöffnet werden) Frontschutz mit Gummileiste Hinterer Gummischutz Unfallschutz nach EU-Vorschriften 	<ul style="list-style-type: none"> Caja de engranajes con rueda libre TDF 1 3/8" Z6 Rotor con sistema de corte helicoidal Arco de tercer punto fijo Rompedor angular Patines de apoyo regulable en altura Tensor de correas regulable Rodillo nivelador trasero (114 mm), con regulación en altura Limpiador montado en el rodillo nivelador trasero Descarga anterior al rodillo nivelador Portón trasero aperturable (solo para inspección) Protección frontal en goma Protección posterior en goma Protecciones de seguridad de acuerdo con la norma CE 	<ul style="list-style-type: none"> Boîtier de transmission avec roue libre PDF 1 3/8" Z6 Rotor avec système de coupe hélicoïdal Châssis fixe Barre brisante Patins d'appui réglables en hauteur Tendeur de courroie réglable Rouleau d'appui arrière réglable en hauteur (114 mm) Racleur pour le rouleau d'appui Ejection devant le rouleau d'appui Capot ouvrant (pour inspection seulement) Protection avant en caoutchouc Protection arrière en caoutchouc Protections contre les accidents aux normes CE

TFL	MULCHER LIGHT DUTY
TFL	MULCHGERÄTE: LEICHTE AUSFÜHRUNG
TFL	TRITURADORA DE HIERBA Y SARMIENTOS
TFL	BROYEUR D'HERBE ET DE SARMENTS

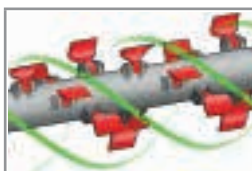
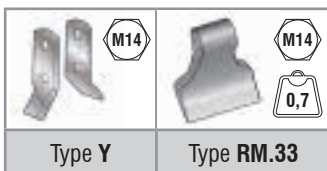
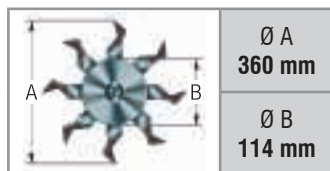

Sistema di taglio elicoidale
Helical cutting system
Spiralrotor
Sistema de corte helicoidal
Système de coupe hélicoïdal

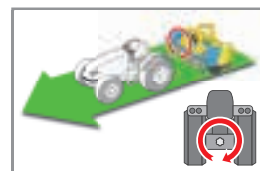

MOD	MOVEMENT MACHINE				WORKING WIDTH		
					Standard		
mod.	cm	cm	cm	cm	nr	nr	nr
TFL 100	61	58	--	--	100	28	14
TFL 115	70	60	--	--	115	32	16
TFL 130	75	70	65	80	130	36	18
TFL 150	86	81	76	91	150	44	22

cod.	A richiesta	On request	Auf Anfrage	Opcionales	Sur demande
5130003	Cardano T-40	PTO shaft T-40	Gelenkwelle T-40	Cardán T-40	Cardan T-40
2050650	Kit di conversione con spostamento laterale idraulico	Conversion kit with hydraulic side-shift	Umrüstsatz mit Hydraulische Verschiebung	Kit de conversión con desplazador lateral hidráulico	Kit de conversion avec déplacement latéral hydraulique

cod.	Ricambi	Spare parts	Ersatzteile	Recambios	Pièces de rechange
5354012	Cinghia BX 39	Cug belt BX 39	Keilriemen BX 39	Correa BX 39	Courroie BX 39
5315011	Vite M14 per utensile	M14 screw for tool	M14 Schraube für Werkzeug	Tornillo M14 para herramienta	Vis M14 pour outil
5323016	Dado M14 per utensile	M14 nut for tool	M14 Mutter für Werkzeug	Tuerca M14 para herramienta	Ecrou M14 pour outil
5350047	Mazza RM.33	Hammer RM.33	Hammer RM.33	Martillo RM.33	Marteau RM.33
5350040	Coltello "Y"	"Y" blade	"Y" Messer	Cuchilla "Y"	Couteau "Y"
2020030	Scatola trasm. TFL100	Gear box TFL100	Getriebe TFL100	Caja de engranajes TFL100	Boîtier de transm. TFL100
2020120	Scatola trasm. TFL115-130	Gear box TFL115-130	Getriebe TFL115-130	Caja de engranajes TFL115-130	Boîtier de transm. TFL115-130
2020162	Scatola trasm. TFL150	Gear box TFL150	Getriebe TFL150	Caja de engranajes TFL150	Boîtier de transm. TFL150

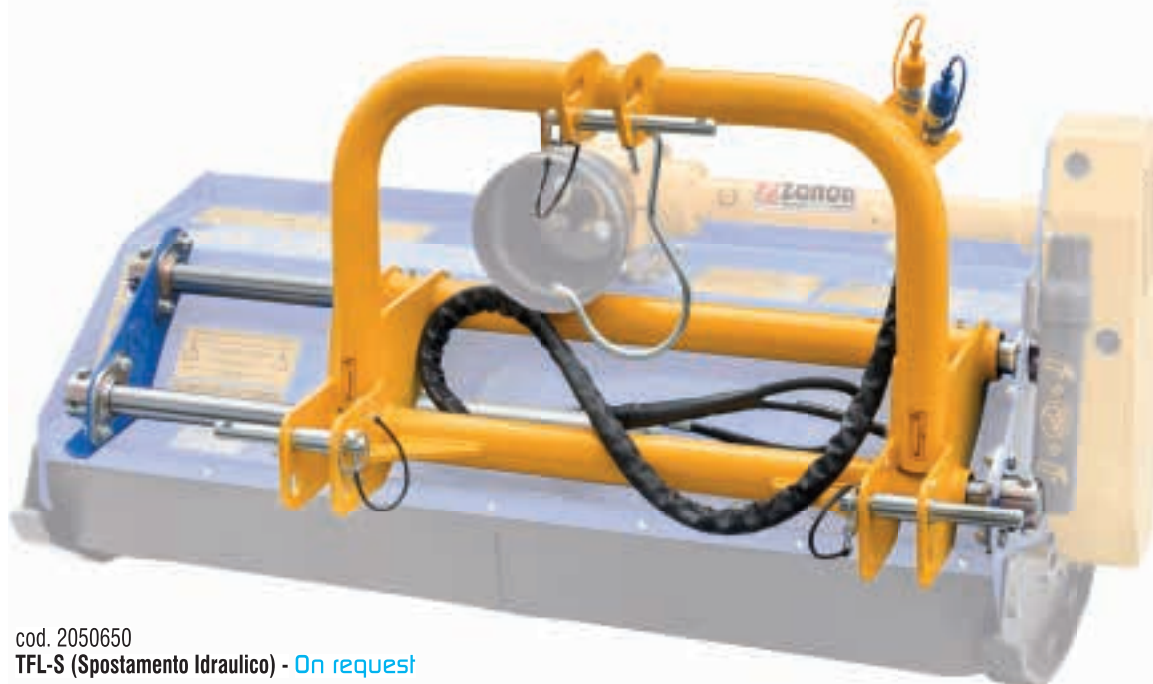

cod. 2050650

TFL-S (Spostamento Idraulico) - On request

Kit di conversione con spostamento laterale idraulico

Conversion kit with hydraulic side-shift

Umrüstsatz mit Hydraulische Verschiebung

Kit de conversión con desplazador lateral hidráulico

Kit de conversion avec déplacement latéral hydraulique

Impiego Use Verwendung Uso Utilisation

La trinciaerba e sarmenti TFL-S è una macchina studiata per essere applicata a trattori di potenza ridotta (12-40 HP). Si presta in modo ottimale per la triturazione di sarmenti, erba, sterpaglie, paglia, e molto altro.





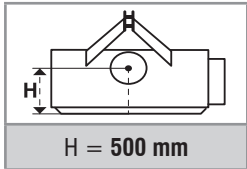

The TFL-S mulcher is designed for mounting on low power tractors (12 to 40 HP). It is ideal for mulching twigs, grass, brushwood, hay and more besides.

Das TFL-S Mulchgerät ist für den Heckanbau an Traktoren mit niedriger Leistung (12 bis 40 HP) ausgelegt. Es eignet sich ideal zum mulchen von Gras, Zweigen und Gestrüpp.

La trituradora de hierba y sarmientos TFL-S es una máquina diseñada para su aplicación en tractores de baja potencia (12-40 HP). Es excelente para triturar sarmientos, hierba, malezas, paja y mucho más.

Le broyeur d'herbe et de sarments TFL-S est une machine conçue pour être appliquée sur des tracteurs de puissance réduite (12-40 HP). Il est particulièrement indiqué pour le broyage de sarments, herbe, broussailles, paille et de nombreux autres végétaux.

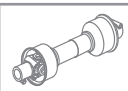
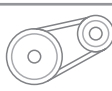

								
mod.	cod.	cod.	HP	rpm/min	type	nr (type)	cm	kg
TFL-S 130	1003035	1003036	15 - 40	540/1000	T-40	2 (BX 39)	145×78×80	250
TFL-S 150	1003037	1003038	20 - 40	540/1000	T-40	2 (BX 39)	167×78×80	265

Versione con spostamento su barre cromate - Version with side shift on chrome bars - Version mit Seitenverschiebung aus vollen Chromstangen
 Versión con desplazamiento lateral mecánico a través de barras cromadas - Version avec déport latéral sur les barres chromées

Di serie	Standard equipment	Serienmässig	Estándar	De série
<ul style="list-style-type: none"> Scatola di trasmissione con ruota libera PTO 1 3/8" Z6 Rotore con sistema di taglio elicoidale Castello fisso Angolare rompitore Slitte d'appoggio regolabili in altezza Tendinghia registrabile Rullo ozioso posteriore regolabile in altezza (114 mm) Raschiafango per pulizia rullo ozioso Scarico anteriore rullo ozioso Cofano apribile (solo per ispezione) Protezione anteriore in gomma Protezione posteriore in gomma Protezioni antinfortunistiche conformi alla normativa CE 	<ul style="list-style-type: none"> Gearbox with freewheel clutch PTO 1 3/8" Z6 Rotor with helical cutting system 3-point linkage fixed Corner reinforcement for shredding material Height-adjustable skids Belt adjuster Rear levelling roller height adjustable (114 mm) Scraper for rear levelling roller Discharge of the material over the levelling roller Opening hood (for inspection only) Front protection with rubber Rear protection with rubber Protective equipment as per EC safety rules 	<ul style="list-style-type: none"> Getriebe mit integriertem Freilauf PTO 1 3/8" Z6 Spiralrotor Anbaubock fest Eckenverstärkung für Zerkleinerungsmaterial Höhenverstellbare Stützkufen Riemenspannung Hintere Stützwalze höhenverstellbar (114 mm) Walzenabstreifer Entladung des Materials über die Walze Heckhaube (darf nur für Wartungsarbeiten geöffnet werden) Frontschutz mit Gummileiste Hinterer Gummischutz Unfallschutz nach EU-Vorschriften 	<ul style="list-style-type: none"> Caja de engranajes con rueda libre TDF 1 3/8" Z6 Rotor con sistema de corte helicoidal Arco de tercer punto fijo Rompedor angular Patines de apoyo regulable en altura Tensor de correas regulable Rodillo nivelador trasero (114 mm), con regulación en altura Limpiador montado en el rodillo nivelador trasero Descarga anterior al rodillo nivelador Portón trasero aperturable (solo para inspección) Protección frontal en goma Protección posterior en goma Protecciones de seguridad de acuerdo con la norma CE 	<ul style="list-style-type: none"> Boîtier de transmission avec roue libre PDF 1 3/8" Z6 Rotor avec système de coupe hélicoïdal Châssis fixe Barre brisante Patins d'appui réglables en hauteur Tendeur de courroie réglable Rouleau d'appui arrière réglable en hauteur (114 mm) Racleur pour le rouleau d'appui Ejection devant le rouleau d'appui Capot ouvrant (pour inspection seulement) Protection avant en caoutchouc Protection arrière en caoutchouc Protections contre les accidents aux normes CE

TFL-S	MULCHER LIGHT DUTY
TFL-S	MULCHGERÄTE: LEICHTE AUSFÜHRUNG
TFL-S	TRITURADORA DE HIERBA Y SARMIENTOS
TFL-S	BROYEUR D'HERBE ET DE SARMENTS

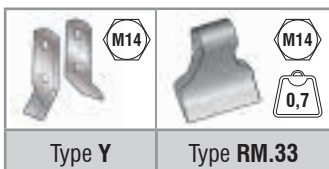
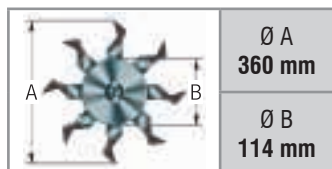

Sistema di taglio elicoidale
Helical cutting system
Spiralrotor
Sistema de corte helicoidal
Système de coupe hélicoïdal



MOD	MOVEMENT MACHINE				WORKING WIDTH	Standard		
mod.	cm	cm	cm	cm	cm	nr	nr	
TFL 130-S	85	60	55	90	30	130	36	18
TFL 150-S	85	82	55	112	30	150	44	22

cod.	A richiesta	On request	Auf Anfrage	Opcionales	Sur demande
5130003	Cardano T-40	PTO shaft T-40	Gelenkwelle T-40	Cardán T-40	Cardan T-40
2050010	Gruppo spost. idraulico 30 cm	Hydraulic side shift 30 cm	Hydraulische Verschiebung 30 cm	Kit desplazador hidr. 30 cm	Groupe de dépl. lat. hydr. 30 cm

cod.	Ricambi	Spare parts	Ersatzteile	Recambios	Pièces de rechange
5354012	Cinghia BX 39	Cug belt BX 39	Keilriemen BX 39	Correa BX 39	Courroie BX 39
5315011	Vite M14 per utensile	M14 screw for tool	M14 Schraube für Werkzeug	Tornillo M14 para herramienta	Vis M14 pour outil
5323016	Dado M14 per utensile	M14 nut for tool	M14 Mutter für Werkzeug	Tuerca M14 para herramienta	Ecrou M14 pour outil
5350047	Mazza RM.33	Hammer RM.33	Hammer RM.33	Martillo RM.33	Marteau RM.33
5350040	Coltello "Y"	"Y" blade	"Y" Messer	Cuchilla "Y"	Couteau "Y"
2020030	Scatola trasm. TFL100	Gear box TFL100	Getriebe TFL100	Caja de engranajes TFL100	Boîtier de transm. TFL100
2020120	Scatola trasm. TFL115-130	Gear box TFL115-130	Getriebe TFL115-130	Caja de engranajes TFL115-130	Boîtier de transm. TFL115-130
2020162	Scatola trasm. TFL150	Gear box TFL150	Getriebe TFL150	Caja de engranajes TFL150	Boîtier de transm. TFL150

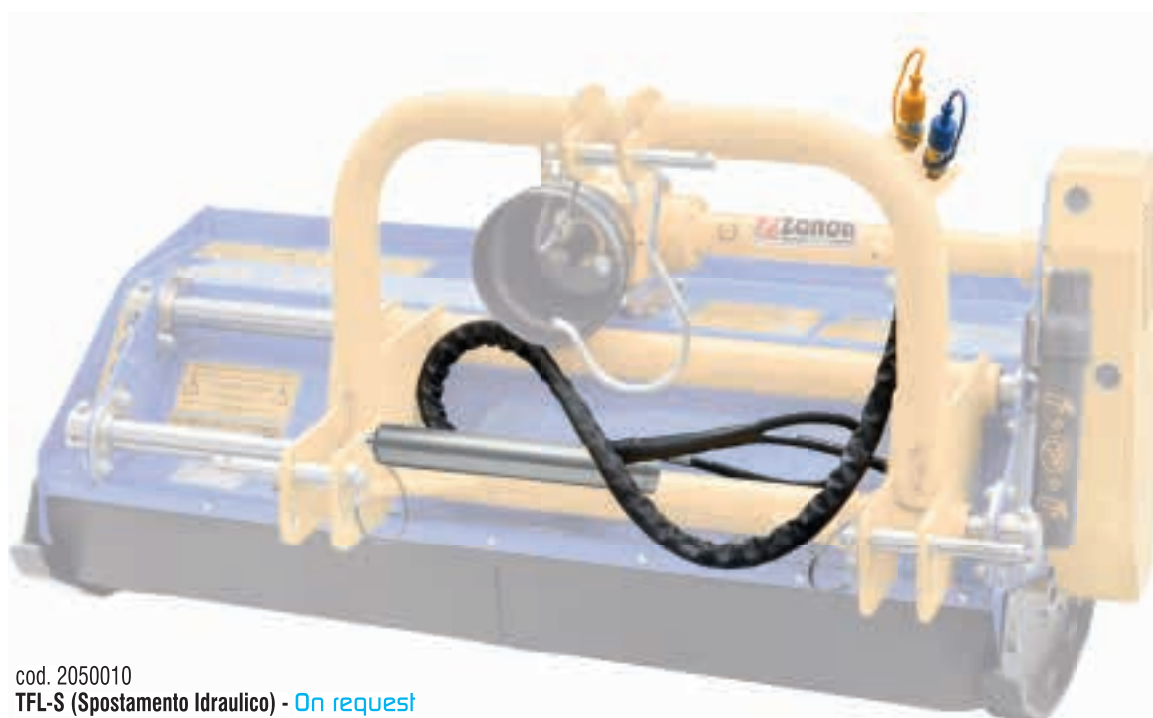

cod. 2050010
TFL-S (Spostamento Idraulico) - On request
Gruppo spostamento laterale idraulico 30 cm
Hydraulic side shift 30 cm
Hydraulische Verschiebung 30 cm
Kit desplazador lateral hidráulico 30 cm
Groupe de déport latéral hydraulique 30 cm

Impiego

La trinciaerba e sarmenti TFX è una macchina studiata per essere applicata a trattori di medio-bassa potenza (25-80 HP). Si presta in modo ottimale per la triturazione di sarmenti, erba, sterpaglie, paglia, e molto altro.

Use

The TFX mulcher is designed for mounting on low to medium power tractors (25-80 HP). It is ideal for mulching twigs, grass, brushwood, hay and more besides.

Verwendung

Das TFX Mulchgerät ist für den Heckanbau an Traktoren mit niedriger bis mittlerer Leistung (25 bis 80 PS) vorgesehen. Es eignet sich ideal zum mulchen von Gras, Zweigen und Gestrüpp.

Uso

La trituradora de hierba y sarmentos TFX es una máquina diseñada para ser aplicada en los tractores de potencia medio baja (25-80 HP). Es excelente para triturar sarmentos, hierba, malezas, paja y mucho más.

Utilisation

Le broyeur d'herbe et de sarments TFX est conçu pour être monté sur des tracteurs de moyenne-basse puissance (25-80 HP). Il est particulièrement indiqué pour le broyage de sarments, herbe, broussailles, paille et de nombreux autres végétaux.

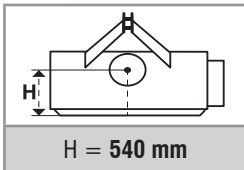

mod.	cod.	cod.	HP	rpm/min	type	nr (type)	cm	kg
TFX 1300	1002448	1002449	25 - 60	540/1000	T-40	3 (BX 45)	145×78×80	310
TFX 1500	1002326	1002327	30 - 60	540/1000	T-40	3 (BX 45)	165×78×80	335
TFX 1700	1002328	1002329	35 - 60	540/1000	T-40	3 (BX 45)	185×78×80	365
TFX 1900	1002452	1002455	35 - 80	540/1000	T-50	3 (BX 45)	205×78×80	395

Di serie	Standard equipment	Serienmässig	Estándar	De série
<ul style="list-style-type: none"> Scatola di trasmissione con ruota libera PTO 1 3/8" Z6 Rotore con sistema di taglio elicoidale Spostamento su rullini in ferro Spostamento laterale meccanico Angolare rompitore Slitte d'appoggio regolabili in altezza Rullo ozioso posteriore regolabile in altezza (114 mm) Raschifango per pulizia rullo ozioso Scarico anteriore rullo ozioso Cofano apribile (solo per ispezione) Protezione anteriore a bandinelle Protezioni antinfortunistiche conformi alla normativa CE 	<ul style="list-style-type: none"> Gearbox with freewheel clutch PTO 1 3/8" Z6 Rotor with helical cutting system Side shift on iron rollers Mechanical side shift Corner reinforcement for shredding material Height-adjustable skids Rear levelling roller height adjustable (114 mm) Scraper for rear levelling roller Discharge of the material over the levelling roller Opening hood (for inspection only) Front protection with metal flaps Protective equipment as per EC safety rules 	<ul style="list-style-type: none"> Getriebe mit integriertem Freilauf PTO 1 3/8" Z6 Spiralrotor Seitenverschiebung über Eisenrollen Mechanische Seitenverschiebung Eckenverstärkung für Zerkleinerungsmaterial Höhenverstellbare Stützkufen Hintere Stützwalze höhenverstellbar (114 mm) Walzenabstreifer Entladung des Materials über die Walze Heckhaube (darf nur für Wartungsarbeiten geöffnet werden) Frontschutz mit Metallklappen Unfallschutz nach EU-Vorschriften 	<ul style="list-style-type: none"> Caja de engranajes con rueda libre TDF 1 3/8" Z6 Rotor con sistema de corte helicoidal Desplazamiento sobre rodillos en acero Desplazamiento lateral mecánico Rompedor angular Patines de apoyo regulable en altura Rodillo nivelador trasero (114 mm), con regulación en altura Limpiador montado en el rodillo nivelador trasero Descarga anterior al rodillo nivelador Portón trasero aperturable (solo para inspección) Protección delantera mediante placas metálicas Protecciones de seguridad de acuerdo con la norma CE 	<ul style="list-style-type: none"> Boîtier de transmission avec roue libre PDF 1 3/8" Z6 Rotor avec système de coupe hélicoïdal Déplacement sur rouleaux métalliques Déport latéral mécanique Barre brisante Patins d'appui réglables en hauteur Rouleau d'appui arrière réglable en hauteur (114 mm) Racleur pour le rouleau d'appui Ejection devant le rouleau d'appui Capot ouvrant (pour inspection seulement) Protection avant avec volets métalliques Protections contre les accidents aux normes CE

TFX	MULCHER LIGHT DUTY
TFX	MULCHGERÄTE: LEICHTE AUSFÜHRUNG
TFX	TRITURADORA DE HIERBA Y SARMIENTOS
TFX	BROYEUR D'HERBE ET DE SARMENTS



ORIGINAL MADE IN ITALY

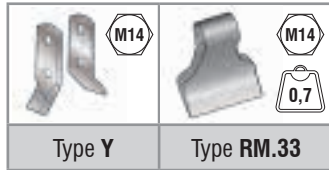
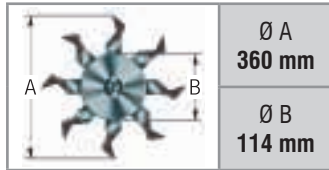

Sistema di taglio elicoidale
Helical cutting system
Spiralrotor
Sistema de corte helicoidal
Système de coupe hélicoïdal



MOD	MOVEMENT MACHINE					WORKING WIDTH	Standard	
	cm		cm		cm		nr	nr
TFX 1300	85	60	55	90	30	130	36	18
TFX 1500	85	80	55	110	30	150	44	22
TFX 1700	85	100	55	130	30	170	48	24
TFX 1900	85	120	55	150	30	190	56	28

cod.	A richiesta	On request	Auf Anfrage	Opcionales	Sur demande
5130003	Cardano T-40	PTO shaft T-40	Gelenkwelle T-40	Cardán T-40	Cardan T-40
5130005	Cardano T-50	PTO shaft T-50	Gelenkwelle T-50	Cardán T-50	Cardan T-50
2050010	Gruppo spost. idr. 30 cm	Hydraulic side shift 30 cm	Hydraulische Verschiebung 30 cm	Kit desplazador hidr. 30 cm	Groupe de dépl. lat. 30 cm

cod.	Ricambi	Spare parts	Ersatzteile	Recambios	Pièces de rechange
5354019	Cinghia BX 45	Cug belt BX 45	Keilriemen BX 45	Correa BX 45	Courroie BX 45
5315011	Vite M14 per utensile	M14 screw for tool	M14 Schraube für Werkzeug	Tornillo M14 para herramienta	Vis M14 pour outil
5323016	Dado M14 per utensile	M14 nut for tool	M14 Mutter für Werkzeug	Tuerca M14 para herramienta	Ecrou M14 pour outil
5350047	Mazza RM.33	Hammer RM.33	Hammer RM.33	Martillo RM.33	Marteau RM.33
5350040	Coltello "Y"	"Y" blade	"Y" Messer	Cuchilla "Y"	Couteau "Y"
2020009	Scatola trasmissione TFX	Gear box TFX	Getriebe TFX	Caja de engranajes TFX	Boîtier de transmission TFX



Impiego Use Verwendung Uso Utilisation

La trinciaerba TFM/P è una macchina studiata per essere applicata a trattori di medio-bassa potenza (25-80 HP). Si presta in modo ottimale per la triturazione di sarmenti, erba, sterpaglie, paglia, e molto altro.

The TFM/P mulcher is designed for mounting on low to medium power tractors (25 to 80 HP). It is ideal for mulching grass, maize, hay, pruning waste (in olive groves, orchards, etc.), brushwood and more besides.

Das TFM/P Mulchgerät ist für den Heckanbau an Traktoren mit niedriger bis mittlerer Leistung (25 bis 80 HP) vorgesehen. Es eignet sich ideal zum mulchen von Wiesen und Weiden dank der Position der hinteren Walze, die eine schnelle und saubere Arbeit ermöglicht.

La trituradora TFM/P es una máquina diseñada para ser aplicada en los tractores de potencia medio baja (25-80 HP). Es excelente para la trituración de hierba, maíz, paja, residuos de poda (en olivares, frutales, etc.), malezas y mucho más

Le broyeur d'herbe TFM/P est conçu pour être monté sur des tracteurs de moyenne-basse puissance (25-80 HP). Il est particulièrement indiqué pour le broyage d'herbe, maïs, paille, déchets d'élagage (dans les oliveraies, les vergers, etc.), de broussailles et autres végétaux.

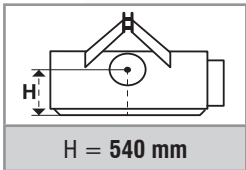

mod.	cod.	cod.	HP	rpm/min	type	nr (type)	cm	kg
TFM/P 1300	1002947	1002943	25 - 60	540/1000	T-40	3 (BX 45)	150×100×80	265
TFM/P 1500	1002948	1002944	30 - 60	540/1000	T-40	3 (BX 45)	170×100×80	305
TFM/P 1700	1002949	1002945	35 - 60	540/1000	T-40	3 (BX 45)	190×100×80	345
TFM/P 1900	1002950	1002946	35 - 80	540/1000	T-50	3 (BX 45)	210×100×80	386

Di serie	Standard equipment	Serienmässig	Estándar	De série
<ul style="list-style-type: none"> Scatola di trasmissione con ruota libera PTO 1 3/8" Z6 Rotore con sistema di taglio elicoidale Spostamento su barre cromate Spostamento laterale meccanico Angolare rompitore Slitte d'appoggio regolabili in altezza Rullo ozioso posteriore regolabile in altezza (114 mm) Scarico posteriore rullo ozioso Protezione posteriore in gomma Protezione anteriore a bandinelle Protezioni antinfortunistiche conformi alla normativa CE 	<ul style="list-style-type: none"> Gearbox with freewheel clutch PTO 1 3/8" Z6 Rotor with helical cutting system Side shift on chrome bars Mechanical side shift Corner reinforcement for shredding material Height-adjustable skids Rear levelling roller height adjustable (114 mm) Discharge of the material before the levelling roller Rear protection with rubber Front protection with metal flaps Protective equipment as per EC safety rules 	<ul style="list-style-type: none"> Getriebe mit integriertem Freilauf PTO 1 3/8" Z6 Spiralrotor Seitenverschiebung über Chromstangen Mechanische Seitenverschiebung Eckenverstärkung für Zerkleinerungsmaterial Höhenverstellbare Stützkufen Hinterer Stützwalze höhenverstellbar (114 mm) Entladung des Materials vor der Walze Hinterer Gummischutz Frontschutz mit Metallklappen Unfallschutz nach EU-Vorschriften 	<ul style="list-style-type: none"> Caja de engranajes con rueda libre TDF 1 3/8" Z6 Rotor con sistema de corte helicoidal Desplazamiento sobre tubo cromado Desplazamiento lateral mecánico Rompedor angular Patines de apoyo regulable en altura Rodillo nivelador trasero (114 mm), con regulación en altura Descarga posterior al rodillo nivelador Protección posterior en goma Protección delantera mediante placas metálicas Protecciones de seguridad de acuerdo con la norma CE 	<ul style="list-style-type: none"> Boîtier de transmission avec roue libre PDF 1 3/8" Z6 Rotor avec système de coupe hélicoïdal Déplacement avec barre chromée Déport latéral mécanique Barre brisante Patins d'appui réglables en hauteur Rouleau d'appui arrière réglable en hauteur (114 mm) Ejection derrière le rouleau d'appui Protection arrière en caoutchouc Protection avant avec volets métalliques Protections contre les accidents aux normes CE

TFM/P	MULCHER LIGHT DUTY WITH DISCHARGE BEHIND THE ROLLER
TFM/P	MULCHGERÄTE LEICHTE AUSFÜHRUNG MIT AUSWURF HINTEN MIT WALZE
TFM/P	TRITURADORA LIGERA CON DESCARGA DETRÁS DEL RODILLO
TFM/P	BROYEUR D'HERBE ET DE SARMENTS



ORIGINAL MADE IN ITALY

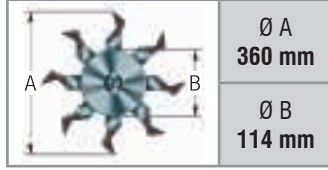

Ø A
360 mm
Ø B
114 mm

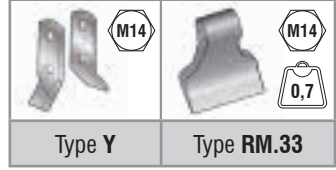

Type Y

Type RM.33



Sistema di taglio elicoidale
Helical cutting system
Spiralrotor
Sistema de corte helicoidal
Système de coupe hélicoïdal



MOD	MOVEMENT MACHINE				
	cm		cm		cm
TFM/P 1300	90	60	60	90	30
TFM/P 1500	90	80	60	110	30
TFM/P 1700	90	100	60	130	30
TFM/P 1900	110	100	90	130	30

WORKING WIDTH	Standard	
	nr	nr
130	36	18
150	44	22
170	48	24
190	56	28

cod.	A richiesta	On request	Auf Anfrage	Opcionales	Sur demande
5130003	Cardano T-40	PTO shaft T-40	Gelenkwelle T-40	Cardán T-40	Cardan T-40
5130005	Cardano T-50	PTO shaft T-50	Gelenkwelle T-50	Cardán T-50	Cardan T-50
2050010	Gruppo spost. idr. 30 cm	Hydraulic side shift 30 cm	Hydraulische Verschiebung 30 cm	Kit desplazador hidr. 30 cm	Groupe de dépl. lat. 30 cm

cod.	Ricambi	Spare parts	Ersatzteile	Recambios	Pièces de rechange
5354019	Cinghia BX 45	Cug belt BX 45	Keilriemen BX 45	Correa BX 45	Courroie BX 45
5315011	Vite M14 per utensile	M14 screw for tool	M14 Schraube für Werkzeug	Tornillo M14 para herramienta	Vis M14 pour outil
5323016	Dado M14 per utensile	M14 nut for tool	M14 Mutter für Werkzeug	Tuerca M14 para herramienta	Ecrou M14 pour outil
5350047	Mazza RM.33	Hammer RM.33	Hammer RM.33	Martillo RM.33	Marteau RM.33
5350040	Coltello "Y"	"Y" blade	"Y" Messer	Cuchilla "Y"	Couteau "Y"
2020009	Scatola trasmissione (*)	Gear box (*)	Getriebe (*)	Caja de engranajes (*)	Boîtier de transmission (*)
2020155	Scatola trasmissione (**)	Gear box (**)	Getriebe (**)	Caja de engranajes (**)	Boîtier de transmission (**)

(*) mod. 1300/1500/1700, (**) mod. 1900

Scarico posteriore al rullo
The cut material is distributed over the top of the roller
Das geschnittene Material wird über die Oberseite der Walze verteilt
Descarga detrás del rodillo
Évacuation à l'arrière du rouleau

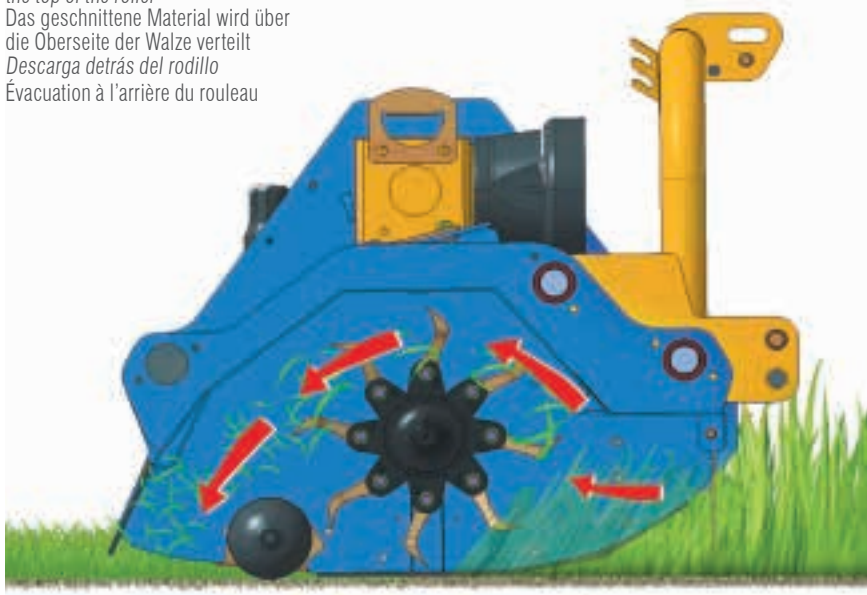

Impiego

Use

Verwendung

Uso

Utilisation

La trinciaerba e sarmenti media TFZ si presta in modo ottimale per la triturazione di sarmenti, mais, erba, sterpaglie, paglia, e molto altro.

The TFZ mulcher medium duty is ideal for mulching twigs, grass, brushwood, hay and more besides.

Das TFZ Mulchgerät ist eines der beliebtesten Modelle in unserem Sortiment. Es eignet sich optimal zum Zerkleinern von Gras, Gehölzschnitt, Mais, Reisig, Ästen, Stroh und vielem mehr.

La trituradora de hierba y sarmentos TFZ es excelente para triturar sarmentos, hierba, malezas, paja y mucho más.

Le broyeur d'herbe et de sarments TFZ est particulièrement indiqué pour le broyage de sarments, herbe, broussailles, paille et de nombreux autres végétaux.

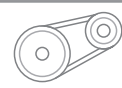
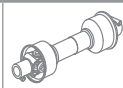
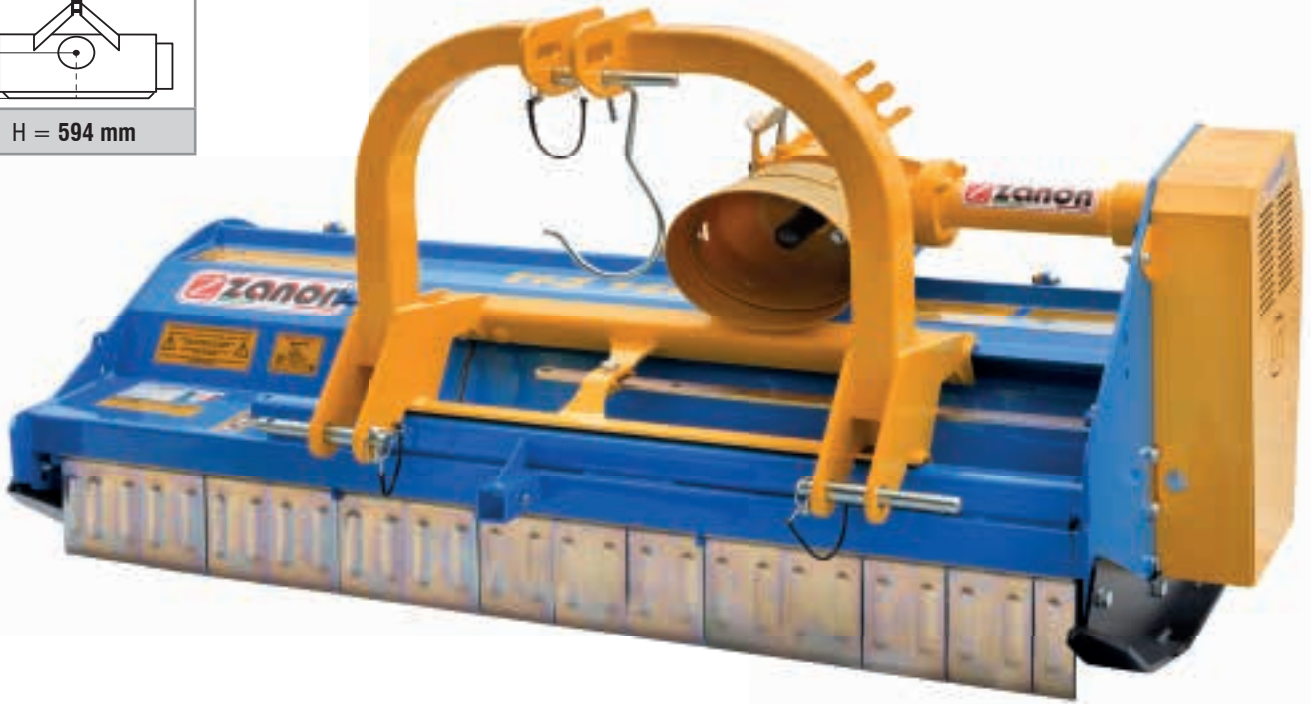
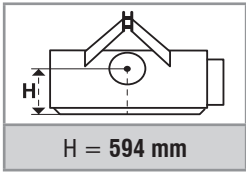

mod.	cod.	cod.	HP	rpm/min	type	nr (type)	cm	kg
TFZ 1400	1002172	1002173	30 - 100	540/1000	T-40	3 (XPB 1250)	160×95×100	415
TFZ 1600	1002152	1002157	30 - 100	540/1000	T-40	3 (XPB 1250)	180×95×100	445
TFZ 1900	1002153	1002158	40 - 100	540/1000	T-50	4 (XPB 1250)	210×95×100	500

Di serie	Standard equipment	Serienmässig	Estándar	De série
<ul style="list-style-type: none"> Scatola di trasmissione con ruota libera PTO 1 3/8" Z6 Rotore con sistema di taglio lineare Spostamento su rullini in ferro Spostamento laterale meccanico Angolare rompitore Slitte d'appoggio regolabili in altezza Rullo ozioso posteriore regolabile in altezza (140 mm) Raschifango per pulizia rullo ozioso Scarico anteriore rullo ozioso Cofano apribile (solo per ispezione) Protezione anteriore a bandinelle Protezioni antinfortunistiche conformi alla normativa CE 	<ul style="list-style-type: none"> Gearbox with freewheel clutch PTO 1 3/8" Z6 Rotor with linear cutting system Side shift on iron rollers Mechanical side shift Corner reinforcement for shredding material Height-adjustable skids Rear levelling roller height adjustable (140 mm) Scraper for rear levelling roller Discharge of the material over the levelling roller Opening hood (for inspection only) Front protection with metal flaps Protective equipment as per EC safety rules 	<ul style="list-style-type: none"> Getriebe mit integriertem Freilauf PTO 1 3/8" Z6 Rotor mit linear Schnittsystem Seitenverschiebung über Eisenrollen Mechanische Seitenverschiebung Eckenverstärkung für Zerkleinerungsmaterial Höhenverstellbare Stützkufen Hintere Stützwalze höhenverstellbar (140 mm) Walzenabstreifer Entladung des Materials über die Walze Heckhaube (darf nur für Wartungsarbeiten geöffnet werden) Frontschutz mit Metallklappen Unfallschutz nach EU-Vorschriften 	<ul style="list-style-type: none"> Caja de engranajes con rueda libre TDF 1 3/8" Z6 Rotor con sistema de corte lineal Desplazamiento sobre rodillos en acero Desplazamiento lateral mecánico Rompedor angular Patines de apoyo regulable en altura Rodillo nivelador trasero (140 mm), con regulación en altura Limpiador montado en el rodillo nivelador trasero Descarga anterior al rodillo nivelador Portón trasero aperturable (solo para inspección) Protección delantera mediante placas metálicas Protecciones de seguridad de acuerdo con la norma CE 	<ul style="list-style-type: none"> Boîtier de transmission avec roue libre PDF 1 3/8" Z6 Rotor avec système de coupe linéaire Déplacement sur rouleaux métalliques Déport latéral mécanique Barre brisante Patins d'appui réglables en hauteur Rouleau d'appui arrière réglable en hauteur (140 mm) Racleur pour le rouleau d'appui Ejection devant le rouleau d'appui Capot ouvrant (pour inspection seulement) Protection avant avec volets métalliques Protections contre les accidents aux normes CE

TFZ	MULCHER MEDIUM DUTY
TFZ	MULCHGERÄTE: MITTELSCHWERE AUSFÜHRUNG
TFZ	TRITURADORA DE HIERBA Y SARMIENTOS
TFZ	BROYEUR D'HERBE ET DE SARMENTS



ORIGINAL MADE IN ITALY

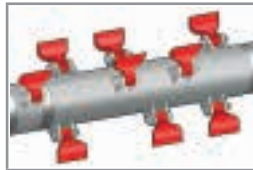
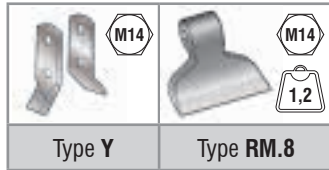
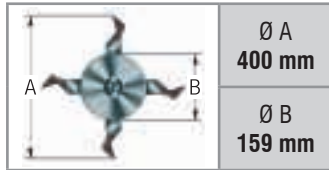

Sistema di taglio lineare
Linear cutting system
Linearrotor
Sistema de corte lineal
Système de coupe linéaire



MOD	MOVEMENT MACHINE					WORKING WIDTH	Standard		On request	
	cm		cm		cm		nr	nr	nr	nr
TFZ 1400	80	80	50	110	30	140	36	18	12	2 + 2
TFZ 1600	87	93	57	123	30	160	40	20	15	3 + 3
TFZ 1900	97	113	57	153	40	190	48	24	18	3 + 3

cod.	A richiesta	On request	Auf Anfrage	Opcionales	Sur demande
5130003	Cardano T-40	PTO shaft T-40	Gelenkwelle T-40	Cardán T-40	Cardan T-40
5130005	Cardano T-50	PTO shaft T-50	Gelenkwelle T-50	Cardán T-50	Cardan T-50
2050010	Gruppo spost. idr. 30 cm	Hydraulic side shift 30 cm	Hydraulische Verschiebung 30 cm	Kit desplazador hidr. 30 cm	Groupe de dépl. lat. 30 cm
2050011	Gruppo spost. idr. 40 cm	Hydraulic side shift 40 cm	Hydraulische Verschiebung 40 cm	Kit desplazador hidr. 40 cm	Groupe de dépl. lat. 40 cm
5210142	Aste di raccolta sarmenti	Twig rakes	Holzaufnahmezinken	Astas de cosecha	Tiges de ramassage
5225854	Aletta spargitrice dx	Spreading wing rh	Verteilerfluegel Rechts	Aleta esparciadora dcha	Ailette de dispersion droite
5225855	Aletta spargitrice sx	Spreading wing lf	Verteilerfluegel Links	Aleta esparciadora izq.	Ailette de dispersion gauche
2050012	Kit ruote posteriori in gomma sterzanti	Rear rubber steering wheels kit	Satz hintere Gummilenkräder	Kit de ruedas traseras, en goma, direccionales	Kit roues arrière directrices en caoutchouc

cod.	Ricambi	Spare parts	Ersatzteile	Recambios	Pièces de rechange
5354003	Cinghia SPB-1250	Cug belt SPB-1250	Keilriemen SPB-1250	Correa SPB-1250	Courroie SPB-1250
5315011	Vite M14 per utensile	M14 screw for tool	M14 Schraube für Werkzeug	Tornillo M14 para herramienta	Vis M14 pour outil
5323016	Dado M14 per utensile	M14 nut for tool	M14 Mutter für Werkzeug	Tuerca M14 para herramienta	Ecrou M14 pour outil
5350024	Mazza RM.8	Hammer RM.8	Hammer RM.8	Martillo RM.8	Marteau RM.8
5350040	Coltello "Y"	"Y" blade	"Y" Messer	Cuchilla "Y"	Couteau "Y"
2020024	Scatola tras. TFZ 1400-1600	Gear box TFZ 1400-1600	Getriebe TFZ 1400-1600	Caja de eng. TFZ 1400-1600	Boîtier de transm. TFZ 1400-1600
2020015	Scatola tras. TFZ 1900	Gear box TFZ 1900	Getriebe TFZ 1900	Caja de eng. TFZ 1900	Boîtier de transm. TFZ 1900



cod. 2050012
On request
Kit ruote posteriori
Rear wheel kit
Satz hinterräder
Kit ruedas posteriores
Kit roues arriere



cod. 2050010 (30 cm)
cod. 2050011 (40 cm)
On request
Kit spostamento idraulico
Hydraulic shift kit
Hydraulik-schaltkit
Kit de cambio hidráulico
Kit de changement hydraulique

Impiego Use Verwendung Uso Utilisation

La trinciaerba e sarmenti media TFZ-PRO si presta in modo ottimale per la triturazione di sarmenti, mais, erba, sterpaglie, paglia, e molto altro.

The TFZ-PRO mulcher medium duty is ideal for mulching twigs, grass, brushwood, hay and more besides.

Das TFZ-PRO Mulchgerät ist eines der beliebtesten Modelle in unserem Sortiment. Es eignet sich optimal zum Zerkleinern von Gras, Gehölzschnitt, Mais, Reisig, Ästen, Stroh und vielem mehr.

La trituradora de hierba y sarmientos TFZ-PRO es excelente para triturar sarmientos, hierba, malezas, paja y mucho más.

Le broyeur d'herbe et de sarments TFZ-PRO est particulièrement indiqué pour le broyage de sarments, herbe, broussailles, paille et de nombreux autres végétaux.

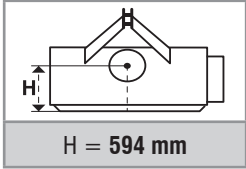

NEW



mod.	cod.	cod.	HP	rpm/min	type	nr (type)	cm	kg
TFZ-PRO 1600	1003292	1003289	30 - 100	540/1000	T-40	3 (XPB 1250)	180×95×100	485
TFZ-PRO 1900	1003293	1003290	40 - 100	540/1000	T-50	4 (XPB 1250)	210×95×100	565
TFZ-PRO 2250	1003294	1003291	50 - 100	540/1000	T-50	5 (XPB 1250)	245×95×100	605
TFZ-PRO 2500	1003295	1003161	60 - 100	540/1000	T-60	5 (XPB 1250)	270×95×100	660
TFZ-PRO 2700	1003071	1003072	80 - 120	540/1000	T-60	5 (XPB 1250)	290×100×100	690

Di serie	Standard equipment	Serienmässig	Estándar	De série
<ul style="list-style-type: none"> Scatola di trasmissione con ruota libera PTO 1 3/8" Z6 Rotore con sistema di taglio lineare Spostamento su barre cromate Spostamento laterale meccanico Angolare rompitore Slitte d'appoggio regolabili in altezza Rullo ozioso posteriore regolabile in altezza (140 mm) Raschiafango per pulizia rullo ozioso Scarico anteriore rullo ozioso Cofano apribile (solo per ispezione) Protezione anteriore a bandinelle Protezioni antinfortunistiche conformi alla normativa CE 	<ul style="list-style-type: none"> Gearbox with freewheel clutch PTO 1 3/8" Z6 Rotor with linear cutting system Side shift on chrome bars Mechanical side shift Corner reinforcement for shredding material Height-adjustable skids Rear levelling roller height adjustable (140 mm) Scraper for rear levelling roller Discharge of the material over the levelling roller Opening hood (for inspection only) Front protection with metal flaps Protective equipment as per EC safety rules 	<ul style="list-style-type: none"> Getriebe mit integriertem Freilauf PTO 1 3/8" Z6 Rotor mit linear Schnittsystem Seitenverschiebung über Chromstangen Mechanische Seitenverschiebung Eckenverstärkung für Zerkleinerungsmaterial Höhenverstellbare Stützkufen Hintere Stützwalze höhenverstellbar (140 mm) Walzenabstreifer Entladung des Materials über die Walze Heckhaube (darf nur für Wartungsarbeiten geöffnet werden) Frontschutz mit Metallklappen Unfallschutz nach EU-Vorschriften 	<ul style="list-style-type: none"> Caja de engranajes con rueda libre TDF 1 3/8" Z6 Rotor con sistema de corte lineal Desplazamiento sobre tubo cromado Desplazamiento lateral mecánico Rompedor angular Patines de apoyo regulable en altura Rodillo nivelador trasero (140 mm), con regulación en altura Limpiador montado en el rodillo nivelador trasero Descarga anterior al rodillo nivelador Portón trasero aperturable (solo para inspección) Protección delantera mediante placas metálicas Protecciones de seguridad de acuerdo con la norma CE 	<ul style="list-style-type: none"> Boîtier de transmission avec roue libre PDF 1 3/8" Z6 Rotor avec système de coupe linéaire Déplacement avec barre chromée Déport latéral mécanique Barre brisante Patins d'appui réglables en hauteur Rouleau d'appui arrière réglable en hauteur (140 mm) Racleur pour le rouleau d'appui Ejection devant le rouleau d'appui Capot ouvrant (pour inspection seulement) Protection avant avec volets métalliques Protections contre les accidents aux normes CE

TFZ-PRO	MULCHER MEDIUM DUTY
TFZ-PRO	MULCHGERÄTE: MITTELSCHWERE AUSFÜHRUNG
TFZ-PRO	TRITURADORA DE HIERBA Y SARMIENTOS
TFZ-PRO	BROYEUR D'HERBE ET DE SARMENTS

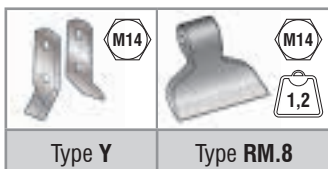
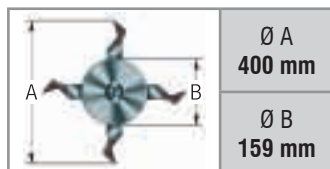

Sistema di taglio lineare
Linear cutting system
Linearrotor
Sistema de corte lineal
Système de coupe linéaire



MOD	MOVEMENT MACHINE				WORKING WIDTH	Standard		On request		
	mod.	cm	cm	cm		cm	nr	nr	nr	nr
TFZ-PRO 1600	110	70	70	110	40	160	40	20	15	3 + 3
TFZ-PRO 1900	110	100	70	140	40	190	48	24	18	3 + 3
TFZ-PRO 2250	125	120	85	160	40	225	56	28	21	3 + 3
TFZ-PRO 2500	135	135	95	175	40	250	64	32	24	4 + 4
TFZ-PRO 2700	149	141	109	181	40	270	68	34	25	4 + 4

cod.	A richiesta	On request	Auf Anfrage	Opcionales	Sur demande
5130003	Cardano T-40	PTO shaft T-40	Gelenkwelle T-40	Cardán T-40	Cardan T-40
5130005	Cardano T-50	PTO shaft T-50	Gelenkwelle T-50	Cardán T-50	Cardan T-50
5130009	Cardano T-60	PTO shaft T-60	Gelenkwelle T-60	Cardán T-60	Cardan T-60
2050011	Gruppo spost. idr. 40 cm	Hydraulic side shift 40 cm	Hydraulische Verschiebung 40 cm	Kit desplazador hidr. 40 cm	Groupe de dépl. lat. 40 cm
5210142	Aste di raccolta sarmenti	Twig rakes	Holzaufnahmezinken	Astas de cosecha	Tiges de ramassage
5225854	Aletta spargitrice dx	Spreading wing rh	Verteilerfluegel Rechts	Aleta esparciadora dcha	Ailette de dispersion droite
5225855	Aletta spargitrice sx	Spreading wing lf	Verteilerfluegel Links	Aleta esparciadora izq.	Ailette de dispersion gauche
2050012	Kit ruote posteriori in gomma sterzanti	Rear rubber steering wheels kit	Satz hintere Gummilenkräder	Kit de ruedas traseras, en goma, direccionales	Kit roues arrière directrices en caoutchouc

cod.	Ricambi	Spare parts	Ersatzteile	Recambios	Pièces de rechange
5354003	Cinghia SPB-1250	Cug belt SPB-1250	Keilriemen SPB-1250	Correa SPB-1250	Courroie SPB-1250
5315011	Vite M14 per utensile	M14 screw for tool	M14 Schraube für Werkzeug	Tornillo M14 para herramienta	Vis M14 pour outil
5323016	Dado M14 per utensile	M14 nut for tool	M14 Mutter für Werkzeug	Tuerca M14 para herramienta	Ecrou M14 pour outil
5350024	Mazza RM.8	Hammer RM.8	Hammer RM.8	Martillo RM.8	Marteau RM.8
5350040	Coltello "Y"	"Y" blade	"Y" Messer	Cuchilla "Y"	Couteau "Y"
2020015	Scatola tras. TFZ-PRO 1600-2250	Gear box TFZ-PRO 1600-2250	Getriebe TFZ-PRO 1600-2250	Caja de eng. TFZ-PRO 1600-2250	Boîtier de transm. TFZ-PRO 1600-2250
2020055	Scatola tras. TFZ-PRO 2500	Gear box TFZ-PRO 2500	Getriebe TFZ-PRO 2500	Caja de engr. TFZ-PRO 2500	Boîtier de transm. TFZ-PRO 2500
2020170	Scatola tras. TFZ-PRO 2700	Gear box TFZ-PRO 2700	Getriebe TFZ-PRO 2700	Caja de engr. TFZ-PRO 2700	Boîtier de transm. TFZ-PRO 2700

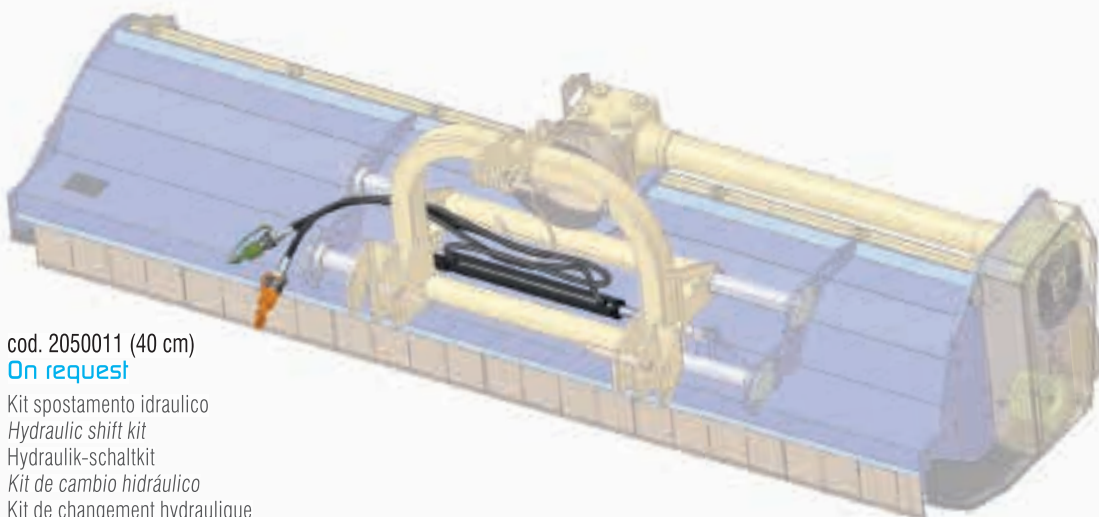

cod. 2050011 (40 cm)
On request

Kit spostamento idraulico
Hydraulic shift kit
Hydraulik-schaltkit
Kit de cambio hidráulico
Kit de changement hydraulique



cod. 2050012
On request

Kit ruote posteriori
Rear wheel kit
Satz hinterräder
Kit ruedas posteriores
Kit roues arriere

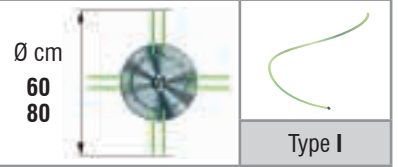
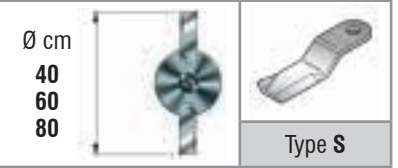

Sistema BREVETTATO di fissaggio del filo
Wire fixing PATENTED system
PATENTIERTES System zur Drahtbefestigung
Sistema PATENTADO de fijación de hilo
Système BREVETÉ de fixation du fil

Versione con lame
Version with blades - Version mit Messern
Versión con cuchillas - Version avec lames

Versione con filo
Wire version - Version mit Faden
Versión con hilo - Version avec fil

mod.	Ø cm	kg	l/min	cod.	nr	Versione con filo		
						cod.	nr	
IT-M / TFZ	40	75	35	1003305	2	--	--	--
IT-M / TMU	40	75	35	1003306	2	--	--	--
IT-M / LFG	40	75	35	1003307	2	--	--	--
IT-M / TFB	40	75	35	1003308	2	--	--	--
IT-M / TFA / TFO	40	75	35	1003309	2	--	--	--
IT-M / TRE-PRO	40	75	35	1003310	2	--	--	--
mod.	Ø cm	kg	l/min	cod.	nr	cod.	nr	
IT-M / TFZ	60	90	35	1003219	2	1003811	4	
IT-M / TMU	60	90	35	1003220	2	1003800	4	
IT-M / LFG	60	90	35	1003221	2	1003801	4	
IT-M / TFB	60	90	35	1003222	2	1003802	4	
IT-M / TFA / TFO	60	90	35	1003223	2	1003803	4	
IT-M / TRE-PRO	60	90	35	1003224	2	1003804	4	
mod.	Ø cm	kg	l/min	cod.	nr	cod.	nr	
IT-M / TFZ	80	110	35	1003225	2	1003805	4	
IT-M / TMU	80	110	35	1003226	2	1003806	4	
IT-M / LFG	80	110	35	1003227	2	1003807	4	
IT-M / TFB	80	110	35	1003228	2	1003808	4	
IT-M / TFA / TFO	80	110	35	1003229	2	1003809	4	
IT-M / TRE-PRO	80	110	35	1003230	2	1003810	4	

IT-M	INTER-ROW DISC FOR MULCHER WITH RETURN SPRING
IT-M	SCHWENKSCHIBE FÜR MULCHER FEDERBELASTET
IT-M	CABEZAL INTERFILAR CON RETORNO A MUELLE
IT-M	TÊTE INTER-RANGS AVEC RETOUR AU RESSORT



Impiego	Use	Verwendung	Uso	Utilisation
---------	-----	------------	-----	-------------

Il disco interfilare a molla IT-M viene applicato alle nostre trincia e permette il taglio dell'erba nell'interceppo senza l'uso di tastatori. Grazie ad una molla di richiamo, quando il disco entra a contatto con il fusto della pianta rientra senza causare danni alla stessa. Il disco interfilare è montato su un sistema di parallele che lo rende flottante, consentendogli di adattarsi ad eventuali irregolarità del terreno. È inoltre possibile regolare l'inclinazione del disco interfilare, così da poter lavorare anche su dirupi o scoli. L'attrezzo richiede una coppia di prese idrauliche al trattore (il trattore deve essere dotato di scarico libero) e minimo 35 lt/min di olio dal trattore.

The IT-M spring-loaded inter-row disc is fitted to our mulchers and allows the grass to be cut in the inter-row without the use of sensors. The inter-row disc, thanks to a return spring, returns when it comes into contact with the plant stem without causing damage to the plant. The inter-row cutter disk is mounted on a parallel guide system that leaves it float and follow the surface of uneven ground. The angle of the inter-row cutter disk can be adjusted to cut the edges of embankments and drainage channels. The implement requires a pair of hydraulic connections to the tractor (the tractor must be equipped with free drainage) and a minimum of 35 l/min of oil from the tractor.

Die federbelastete IT-M Zwischenreihen-Scheibe ist an unseren Mulchern angebracht und ermöglicht das Schneiden des Grases in der Zwischenreihe ohne den Einsatz von Sensoren. Die Zwischenreihenscheibe kehrt dank einer Rückholfeder zurück, wenn sie mit dem Pflanzstamm in Berührung kommt, ohne die Pflanze zu beschädigen. Die Mähscheibe ist auf einem System von Parallelen montiert, das sie schwimmend macht, so dass sie sich an alle Unebenheiten des Bodens anpassen kann. Es ist auch möglich, die Neigung der Scheibe einzustellen. Das Gerät benötigt ein Paar hydraulische Anschlüsse zum Traktor (der Traktor muss mit freiem Abfluss ausgestattet sein) und eine Mindestölmenge von 35 l/min vom Traktor.

El disco interfilare IT-M accionado mediante muelle, se puede aplicar a la gama de desbrozadoras/trituradoras no reversibles disponibles, permitiendo el corte de la broza entre los centros de las plantas. El disco interfilare, gracias a su muelle regulable en tensión, al entrar en contacto con el tronco de la planta, se retira del centro de la misma, cortando la broza en torno a ella y no efectúa daños en ella. El disco interlíneas está montado en un sistema de paralelas y es flotante para permitirle seguir las irregularidades del terreno. También es posible regular la inclinación del disco interlíneas, para poder trabajar en canales y pendientes. El interfilare va acoplado al hidráulico del tractor, por lo tanto se requieren un distribuidor doble y con la descarga directa al tanque, la capacidad mínima de aceite necesaria para el accionamiento del interfilare es de 35 litros.

Le disque interligne IT-M avec retour à ressort monté sur nos broyeurs permet de couper l'herbe entre les interceps sans l'utilisation de le palpeur hydraulique. Le disque interligne, grâce à sa ressort speciale, pendant le contact avec la plante ne cause aucun dégât à la même. Le disque inter-rangs est monté sur un système de guidages parallèles qui le rend flottant, en lui permettant de s'adapter aux éventuelles irrégularités du sol. Il est possible également de régler l'inclinaison du disque inter-rangs de manière à pouvoir travailler aussi sur les pentes raides ou les fossés. L'outil exige deux prises hydrauliques côté tracteur (le tracteur doit avoir le décharge libre) et au moins 35 lt/min d'huile de le circuit du tracteur.

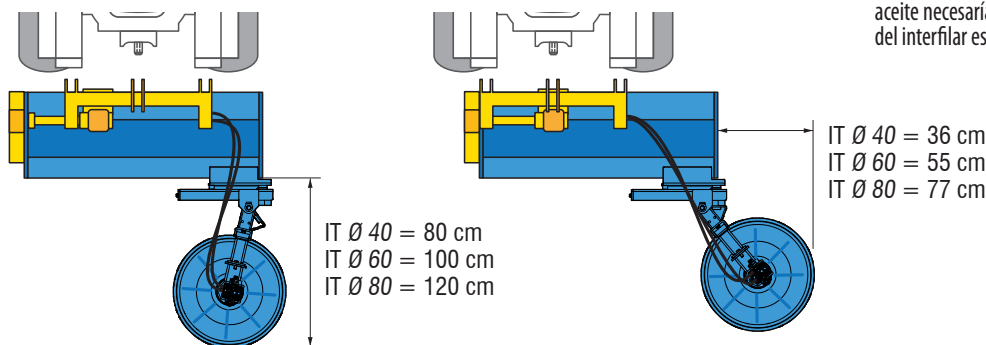

MOVIMENTO 1 / MOVEMENT 1

Inclinazione testata
Inter-row disc inclination
Zwischenreihenscheibe neigung
Inclinación de disco entre hileras
Disque inter-rangée



MOVIMENTO 2 / MOVEMENT 2

Regolazione meccanica altezza asse
Arm's height mechanical adjustment
Mechanische Einstellung Arbeitsposition
Regulación de altura
Réglage hauteur axe

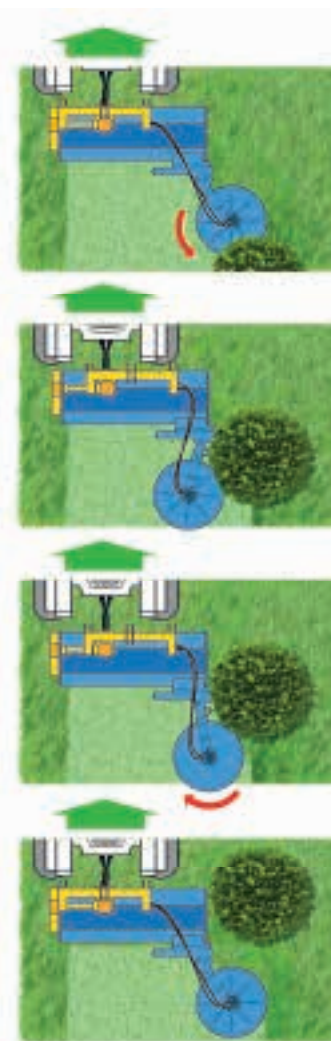

cod.	A richiesta	On request	Auf Anfrage	Opcionales	Sur demande
2051250	Kit trasformazione da lame a filo per IT-M Ø60/Ø80	Conversion kit from blades to wire for IT-M Ø60/Ø80	Umrüstsatz von Klingen auf Draht für IT-M Ø60/Ø80	Kit de conversión de cuchillas a hilo para IT-M Ø60/Ø80	Kit de conversion de lames à fil pour IT-M Ø60/Ø80

















cod.	Ricambi	Spare parts	Ersatzteile	Recambios	Pièces de rechange
5421033	Motore testata	Inter-row motor	Zwischenreihen-Vorsatzgerät Motor	Motor de cabezal	Moteur tete
5350165	Lama	Blade	Messer	Cuchilla	Couteau
5335070	Molla rientro testata	Return spring	Rückholfeder	Muelle de retorno	Ressort de rappel

Impiego	Use	Verwendung	Uso	Utilisation
La testata interfilare IT è un accessorio applicabile alla trincia ed è utile per la pulizia attorno al fusto delle piante e dell'interfila, senza provocare danni alla corteccia.	The IT inter-row head accessory fits on the mulcher and cleans around the stems of crop plants and in alleyways without damaging the crop plants themselves.	Die IT Mähscheibe passt auf den Mulcher und ist so konstruiert, dass sie das Gras um die Bäume herum mäht, ohne die Ernte zu beschädigen.	El cabezal interlíneas IT es un accesorio que se monta en la trituradora y que sirve para limpiar alrededor de las plantas y las interlíneas sin dañar la corteza.	La tête inter-rangs IT est un accessoire applicable au broyeur, utile pour le nettoyage autour du tronc des plants et dans les espaces inter-rangs, sans endommager l'écorce.



Sistema BREVETTATO di fissaggio del filo
Wire fixing PATENTED system
PATENTIERTES System zur Drahtbefestigung
Sistema PATENTADO de fijación de hilo
Système BREVETÉ de fixation du fil



				Versione con lame Version with blades - Version mit Messern Versión con cuchillas - Version avec lames			Versione con filo Wire version - Version mit Faden Versión con hilo - Version avec fil		
Ø 50									
mod.	cm	lt	kg	cod.	nr	cod.	nr		
IT / TFZ	50	40	120	1002546	2	1003207	4		
IT / TMU	50	40	120	1002563	2	1003799	4		
IT / LFG	50	40	120	1002594	2	1003208	4		
IT / TFB	50	40	120	1002625	2	1003209	4		
IT / TFA / TFO	50	40	120	1002821	2	1003210	4		
IT / TRE-PRO	50	40	120	1002951	2	1003211	4		
Ø 70									
mod.	cm	lt	kg	cod.	nr	cod.	nr		
IT / TFZ	70	40	135	1002909	2	1003212	4		
IT / TMU	70	40	135	1002911	2	1003213	4		
IT / LFG	70	40	135	1002913	2	1003214	4		
IT / TFB	70	40	135	1002914	2	1003215	4		
IT / TFA / TFO	70	40	135	1002915	2	1003216	4		
IT / TRE-PRO	70	40	135	1002952	2	1003101	4		

Di serie	Standard equipment	Serienmässig	Estándar	De série
<ul style="list-style-type: none"> Distributore di esclusione della testata interfilare Distributore accensione del gruppo lame Serbatoio di olio da 40 litri Kit attacco pompa Protezioni antinfortunistiche conformi alla normativa CE 	<ul style="list-style-type: none"> Inter-row head retraction distributor Cutter drive distributor 40 liters hydraulic fluid tank Pump drive kit Protective equipment as per EC safety rules 	<ul style="list-style-type: none"> Ausschlussverteilergetriebe des interfilaren Kopfs Verteilergetriebe und Einschalten Schnittblattgruppe 40 l - Ölbehälter Pumpenanschluss Unfallschutz nach EU-Vorschriften 	<ul style="list-style-type: none"> Distribuidor de desactivación del cabezal interlíneas Distribuidor y encendido del grupo de cuchillas Depósito de aceite de 40 litros Kit de conexión de bomba Protecciones de seguridad de acuerdo con la norma CE 	<ul style="list-style-type: none"> Distributeur d'exclusion de la tête inter-rangs Distributeur et allumage du groupe des lames Réservoir d'huile de 40 litres Kit de raccord pompe Protections contre les accidents aux normes CE

IT	INTER-ROW DISC FOR MULCHER
IT	HYDRAULISCHE SCHWENKSCHIBE FÜR MULCHER
IT	CABEZAL INTERFILAR CON PALPADOR HIDRÁULICO
IT	TÊTE INTER-RANGS AVEC PALPEUR HYDRAULIQUE



Il disco interfilare è montato su un sistema di parallele che lo rende flottante, consentendogli di adattarsi ad eventuali irregolarità del terreno. È, inoltre, possibile regolare l'inclinazione del disco interfilare, così da poter lavorare anche su dirupi o scoli.

The inter-row cutter disk is mounted on a parallel guide system that leaves it float and follow the surface of uneven ground. The angle of the inter-row cutter disk can be adjusted to cut the edges of embankments and drainage channels.

Die Mähscheibe ist auf einem System von Parallelen montiert, das sie schwimmend macht, so dass sie sich an alle Unebenheiten des Bodens anpassen kann. Es ist auch möglich, die Neigung der Scheibe einzustellen.

El disco interlíneas está montado en un sistema de paralelas y es flotante para permitirle seguir las irregularidades del terreno. También es posible regular la inclinación del disco interlíneas, para poder trabajar en canales y pendientes.

Le disque inter-rangs est monté sur un système de guidages parallèles qui le rend flottant, en lui permettant de s'adapter aux éventuelles irrégularités du sol. Il est possible également de régler l'inclinaison du disque inter-rangs de manière à pouvoir travailler aussi sur les pentes raides ou les fossés.

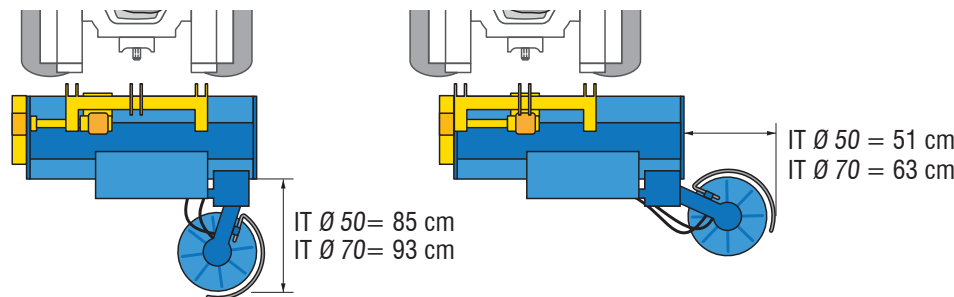

MOVIMENTO 1 / MOVEMENT 1

Inclinazione testata
Inter-row disc inclination
Zwischenreihenscheibe neigung
Inclinación de disco entre hileras
Disque inter-rangée



MOVIMENTO 2 / MOVEMENT 2

Regolazione meccanica altezza asse
Arm's height mechanical adjustment
Mechanische Einstellung Arbeitsposition
Regulación de altura
Réglage hauteur axe

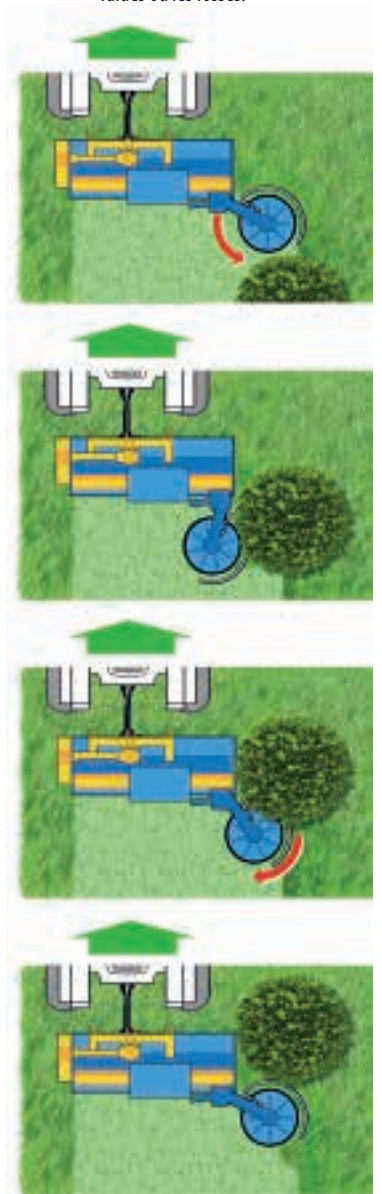

cod.	A richiesta	On request	Auf Anfrage	Opcionales	Sur demande
5444295	Kit richiamo testata meccanico direttamente dal trattore	Mechanical head recall kit directly from the tractor	Mechanischer Kopf-Rücklaufsatz direkt vom Traktor	Kit de accionamiento del cabezal directamente del tractor	Kit arret tete mecanique directement de le tracteur
2051251	Kit trasformazione da lame a filo per IT $\varnothing 50 / \varnothing 70$	Conversion kit from blades to wire for IT $\varnothing 50 / \varnothing 70$	Umrüstsatz von Klingen auf Draht für IT $\varnothing 50 / \varnothing 70$	Kit de conversión de cuchillas a hilo para IT $\varnothing 50 / \varnothing 70$	Kit de conversion de lames à fil pour IT $\varnothing 50 / \varnothing 70$

cod.	Ricambi	Spare parts	Ersatzteile	Recambios	Pièces de rechange
5110025	Semigiunto	Half coupling	Kupplungshälfte	Mitad de acoplamiento	Demi-accouplement
5421016	Pompa doppia	Double pump	Doppelpumpe	Bomba doble	Pompe double
5421015	Motore testata ($\varnothing 70$)	Inter-row motor ($\varnothing 70$)	Zwischenreihen-Vorsatzgerät Mot. ($\varnothing 70$)	Motor de cabezal ($\varnothing 70$)	Moteur tete ($\varnothing 70$)
5421019	Motore testata ($\varnothing 50$)	Inter-row motor ($\varnothing 50$)	Zwischenreihen-Vorsatzgerät Mot. ($\varnothing 50$)	Motor de cabezal ($\varnothing 50$)	Moteur tete ($\varnothing 50$)
5314009	Filtro	Filter	Filter	Filtro	Filtre
5350117	Lama	Blade	Messer	Cuchilla	Couteau
5335027	Tastatore	Hyd. Finger	Schwenkscheibe	Palpador	Palpeur

Impiego	Use	Verwendung	Uso	Utilisation
---------	-----	------------	-----	-------------

La testata interfilare IT-PRO è un accessorio applicabile alla trincia ed è utile per la pulizia attorno al fusto delle piante e dell'interfila, senza provocare danni alla corteccia.

The IT-PRO inter-row head accessory fits on the mulcher and cleans around the stems of crop plants and in alleyways without damaging the crop plants themselves.

Die IT-PRO Mähscheibe passt auf den Mulcher und ist so konstruiert, dass sie das Gras um die Bäume herum mäht, ohne die Ernte zu beschädigen.

El cabezal interlíneas IT-PRO es un accesorio que se monta en la trituradora y que sirve para limpiar alrededor de las plantas y las interlíneas sin dañar la corteza.

La tête inter-rangs IT-PRO est un accessoire applicable au broyeur, utile pour le nettoyage autour du tronc des plants et dans les espaces inter-rangs, sans endommager l'écorce.

Di serie

- Serbatoio olio indipendente 40 lt
- Doppio sistema filtrante
- Kit attacco pompa
- Scambiatore di calore
- Joystick multifunzione
- Regolazione inclinazione, apertura/chiusura testata, on/off rotore, tutto tramite joystick
- Protezioni antinfortunistiche conformi alla normativa CE

Standard equipment

- Independent oil tank 40 lt
- Double filtering system
- Pump connection kit
- Heat exchanger
- Multifunction Joystick
- Tilt adjustment, opening/closing head, on/off rotor, all with joystick
- Protective equipment as per EC safety rules

Estándar

- Depósito de aceite independiente de 40 litros
- Sistema doble filtrante
- Kit acople bomba
- Intercambiador de calor
- Joystick multifunción
- Ajuste de inclinación, apertura/cierre de la cabeza, encendido/apagado rotor, todo con joystick
- Protecciones de seguridad de acuerdo con la norma CE

Serienmässig

- Unabhängiger Öltank 40 lt
- Doppeltes Filtersystem
- Pumpenanschluss-Satz
- Wärmetauscher
- Multifunktions-Joystick
- Neigungsverstellung, Öffnungs-/Schließkopf, Ein/Aus-Rotor, alle mit Joystick
- Unfallschutz nach EU-Vorschriften

De série

- Réservoir d'huile indépendant de 40 l
- Double système de filtration
- Kit connexion pompe
- Echangeur de chaleur
- Joystick multifonction
- Réglage de l'inclinaison, ouverture/fermeture de la tête, marche/arrêt rotor, tout avec joystick
- Protections contre les accidents aux normes CE



Sistema BREVETTATO di fissaggio del filo
Wire fixing PATENTED system
PATENTIERTES System zur Drahtbefestigung
Sistema PATENTADO de fijación de hilo
Système BREVETÉ de fixation du fil



Versione con lame
Version with blades - Version mit Messern
Versión con cuchillas - Version avec lames

Versione con filo
Wire version - Version mit Faden
Versión con hilo - Version avec fil

Ø 50				Ø 70			
mod.	cm	lt	kg	cod.	nr	cod.	nr
IT-PRO / TFZ	50	40	130	1003183	2	1003195	4
IT-PRO / TMU	50	40	130	1003184	2	1003196	4
IT-PRO / LFG	50	40	130	1003185	2	1003197	4
IT-PRO / TFB	50	40	130	1003186	2	1003198	4
IT-PRO / TFA / TFO	50	40	130	1003187	2	1003199	4
IT-PRO / TRE-PRO	50	40	130	1003188	2	1003200	4
IT-PRO / TFZ	70	40	145	1003189	2	1003201	4
IT-PRO / TMU	70	40	145	1003190	2	1003202	4
IT-PRO / LFG	70	40	145	1003191	2	1003203	4
IT-PRO / TFB	70	40	145	1003192	2	1003204	4
IT-PRO / TFA / TFO	70	40	145	1003193	2	1003205	4
IT-PRO / TRE-PRO	70	40	145	1003194	2	1003206	4

IT-PRO	INTER-ROW DISC FOR MULCHER WITH HYDRAULIC PROBE with JOYSTICK
IT-PRO	HYDRAULISCHE SCHWENKSCHIBE FÜR MULCHER mit JOYSTICK
IT-PRO	CABEZAL INTERFILAR CON PALPADOR HIDRÁULICO con JOYSTICK
IT-PRO	TÊTE INTER-RANGS AVEC PALPEUR HYDRAULIQUE avec JOYSTICK

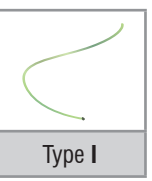
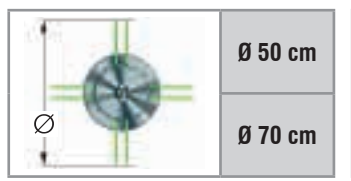
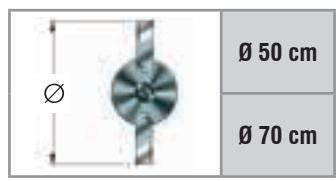

Il disco interfilare è montato su un sistema di parallele che lo rende flottante, consentendogli di adattarsi ad eventuali irregolarità del terreno. È, inoltre, possibile regolare l'inclinazione del disco interfilare, così da poter lavorare anche su dirupi o scoli.

The inter-row cutter disk is mounted on a parallel guide system that leaves it float and follow the surface of uneven ground. The angle of the inter-row cutter disk can be adjusted to cut the edges of embankments and drainage channels.

Die Mähscheibe ist auf einem System von Parallelen montiert, das sie schwimmend macht, so dass sie sich an alle Unebenheiten des Bodens anpassen kann. Es ist auch möglich, die Neigung der Scheibe einzustellen.

El disco interlíneas está montado en un sistema de paralelas y es flotante para permitirle seguir las irregularidades del terreno. También es posible regular la inclinación del disco interlíneas, para poder trabajar en canales y pendientes.

Le disque inter-rangs est monté sur un système de guidages parallèles qui le rend flottant, en lui permettant de s'adapter aux éventuelles irrégularités du sol. Il est possible également de régler l'inclinaison du disque inter-rangs de manière à pouvoir travailler aussi sur les pentes raides ou les fossés.

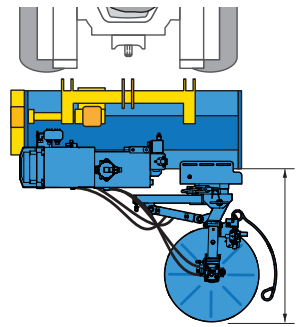

IT Ø 50 = 85 cm
IT Ø 70 = 93 cm

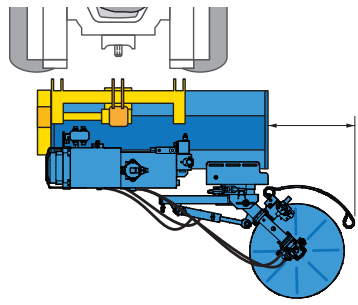

IT Ø 50 = 51 cm
IT Ø 70 = 63 cm

MOVIMENTO 1 / MOVEMENT 1

- Inclinazione testata (con joystick multifunzione)
- Inter-row disc inclination (with multifunction joystick)
- Zwischenreihenscheibe neigung (mit Multifunktions-Joystick)
- Inclinación de disco entre hileras (con joystick multifunción)
- Disque inter-rangée (avec joystick multifonction)



MOVIMENTO 2 / MOVEMENT 2

- Regolazione meccanica altezza asse
- Arm's height mechanical adjustment
- Mechanische Einstellung Arbeitsposition
- Regulación de altura
- Réglage hauteur axe

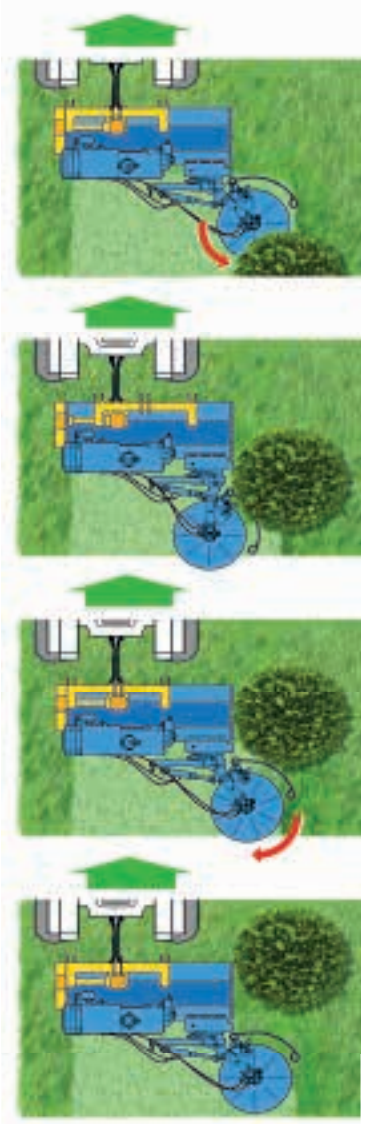

cod.	A richiesta	On request	Auf Anfrage	Opcionales	Sur demande
2051251	Kit trasformazione da lame a filo per IT Ø50/Ø70	Conversion kit from blades to wire for IT Ø50 / Ø70	Umrüstsatz von Klingen auf Draht für IT Ø50 / Ø70	Kit de conversión de cuchillas a hilo para IT Ø50 / Ø70	Kit de conversion de lames à fil pour IT Ø50 / Ø70

cod.	Ricambi	Spare parts	Ersatzteile	Recambios	Pièces de rechange
5110025	Semigiunto	Half coupling	Kupplungshälfte	Mitad de acoplamiento	Demi-accouplement
5421046	Pompa singola	Single pump	Einzelpumpe	Bomba simple	Pompe simple
5421019	Motore testata	Inter-row motor	Zwischenreihen-Vorsatzgerät	Motor de cabezal	Moteur tete
5314020	Filtro	Filter	Filter	Filtro	Filtre
5350117	Lama	Blade	Messer	Cuchilla	Couteau
5450065	Bobina filo 155 mt Ø 6 mm	Wire 155 mt Ø 6 mm	Garnrolle 155 mt Ø 6 mm	Hilo 155 mt Ø 6 mm	Bobine de fil 155 mt Ø 6 mm
5335027	Tastatore	Hyd. Finger	Schwenscheibe	Palpador	Palpeur

IT-PRO

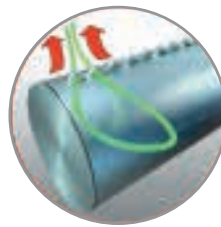
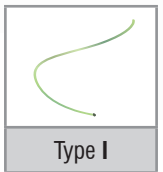



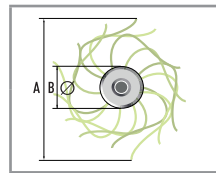

Sistema rapido per il cambio dei fili
Quick and tool-free wire replacement system
 Schnelles und werkzeugloses Drahtwechselsystem
 Sistema cambio de hilo rápido
 Système rapide de remplacement du fil

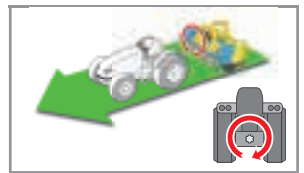

Ø A
450 mm
 Ø B
130 mm



			
SCAN ME!			
mod.	cod.	lt	kg
DMI / TFZ	1002882	40	280
DMI / TMU	1002884	40	280
DMI / LFG	1002886	40	280
DMI / TFB	1002887	40	280
DMI / TFA / TFO	1002888	40	280
DMI / TRE	1003005	40	280

Di serie	Standard equipment	Serienmässig	Estándar	De série
<ul style="list-style-type: none"> Seratoio da 40 litri indipendente Doppio sistema filtrante Kit attacco pompa Raccorderia oleodinamica con attacchi a sgancio rapido per una veloce rimozione della macchina Kit scambiatore di calore Posizioni di lavoro gestite direttamente dalla trattrice tramite Joystick multifunzione removibile Regolazione giri motore Blocco distribuzione gestito elettronicamente Accensione-spegnimento 1 set di fili pre-installato Sistema rapido per il cambio dei fili Protezioni antinfortunistiche conformi alla normativa CE 	<ul style="list-style-type: none"> Independent 40 liters tank Double filtering system Pump connection kit Hydraulic fittings with quick release connections for a quick removal of the machine Heat exchanger kit Working positions managed directly by the tractor using a removable multifunction joystick Engine revolutions adjustment Electronically managed distribution block On-off switching 1 set of pre-installed wires Quick and tool-free wire replacement system Protective equipment as per EC safety rules 	<ul style="list-style-type: none"> Unabhängiger 40Lt Tank Doppeltes Filtersystem Pumpenverbindingssatz Hydraulische Armaturen mit Schnellkupplungen für eine schnelle Demontage der Maschine Wärmetauscher-Kit Direkte Steuerung der Arbeitspositionen durch den Traktor mit einem abnehmbaren Multifunktions-Joystick Einstellung der Motordrehzahl Elektronisch gesteuerter Verteilerblock Ein-Aus-Schaltung 1 Satz vorinstallierter Drähte Schnelles und werkzeugloses Drahtwechselsystem Unfallschutz nach EU-Vorschriften 	<ul style="list-style-type: none"> Tanque de 40 litros independiente Doble sistema de filtrado Kit de conexión de bomba Accesorios hidráulicos con conexiones de liberación rápida para una rápida extracción de la máquina Kit de intercambiador de calor Posiciones de trabajo gestionadas directamente por el tractor mediante un joystick Ajuste de revoluciones del motor Bloque de distribución gestionado electrónicamente Encendido-apagado 1 juego de cables preinstalados Sistema cambio de hilo rápido Protecciones de seguridad de acuerdo con la norma CE 	<ul style="list-style-type: none"> Réservoir indépendant 40 litres Système de double filtration Kit de connexion de pompe Raccords hydrauliques avec raccords rapides pour un retrait rapide de la machine Kit échangeur de chaleur Positions de travail gérées directement par le tracteur à l'aide d'un joystick multifonction amovible Réglage de la rotation du moteur Bloc de distribution géré électroniquement Commutation marche-arrêt 1 jeu de fils pré-installés Système rapide de remplacement du fil Protections contre les accidents aux normes CE

cod.	Ricambi	Spare parts	Ersatzteile	Recambios	Pièces de rechange
5450043	Bobina filo 630 mt Ø 4 mm	Wire 630 mt Ø 4 mm	Garnrolle 630 mt Ø 4 mm	Hilo 630 mt Ø 4 mm	Bobine de fil 630 mt Ø 4 mm

DMI	INTER-ROW WEEDER FOR FLAIL MOWER
DMI	MECHANISCHE UNKRAUTMÄHBÜRSTE FÜR MULCHER
DMI	DESBROZADORA INTERFILA MECÁNICA
DMI	MACHINE À ÉBOURGEONNER AVEC PALPEUR MÉCANIQUE

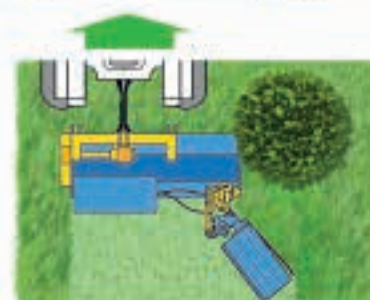
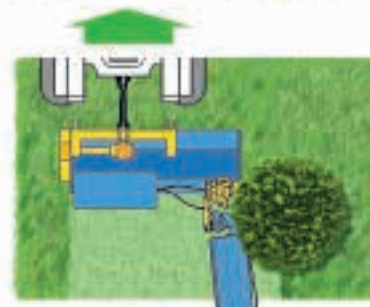
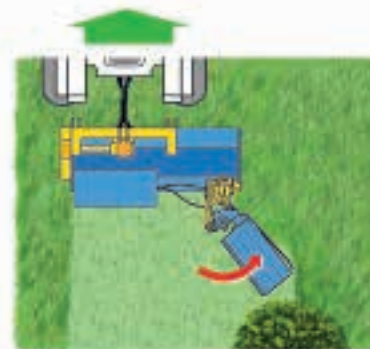
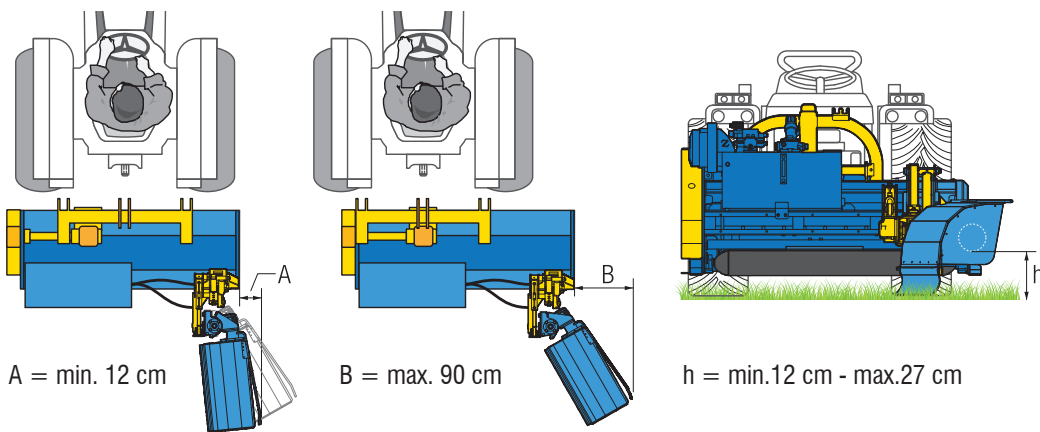

MOVIMENTO 1 / MOVEMENT 1



Apertura e chiusura braccio diserbatrice meccanica
 Arm opening and closing
 Antishock System: Anfahrssicherung
 Apertura y cierre del brazo mecánico
 Ouverture et fermeture du bras

MOVIMENTO 2 / MOVEMENT 2



Regolazione altezza asse rullo
 Arm's height adjustment
 Einstellung Arbeitsposition
 Regulación de altura del rodillo
 Réglage hauteur axe du rouleau



Sistema antishock regolabile per l'attenuazione dell'urto
 Adjustable anti-shock system for shock absorption
 Einstellbares Anfahrssicherung-System zur Stoßdämpfung
 Sistema anti impacto regulable para amortiguar golpe
 Système antichoc réglable pour atténuer l'impact



Rientro testata con sistema a molla
 Movement with spring system
 Schwenkung mit Federsystem
 Cierre y apertura del cabezal con sistema de muelle
 Retour de tête avec système de ressort



Regolazione giri rotore
 Rotor speed control
 Einstellung Rotorgeschwindigkeit
 Regulación vueltas rotor
 Réglage de la vitesse du rotor



DMI

Impiego Use Verwendung Uso Utilisation

La trinciaerba e sarmenti TFG si presta in modo ottimale per la triturazione di sarmenti, mais, erba, sterpaglie, paglia, e molto altro. È studiata particolarmente per lavorazioni in frutteto e in piantagioni a file grazie alla compattezza, alle ridotte misure d'ingombro, e ai carter stretti

The TFG mulcher is ideal for mulching twigs, maize, grass, brushwood, hay and more besides. Its compact design, small size and narrow body make it ideal for work in orchards and between rows.

Der Gras- und Weinbergmulcher TFG ist perfekt zum Häckseln von Ranken, Mais, Gras, Gestrüpp, Stroh und vieles andere mehr. Dank kompakter Bauweise, geringen Abmessungen und schmalen Gehäusen speziell für die Arbeit in Obstplantagen und Reihenkulturen ausgelegt.

La trituradora de hierba y sarmientos TFG es excelente para triturar sarmientos, maíz, hierba, malezas, paja y mucho más. Ha sido diseñada especialmente para los trabajos en frutales y plantaciones lineales gracias a su tamaño compacto, a sus dimensiones reducidas y a los cárteres pequeños.

Le broyeur d'herbe et de sarments TFG est particulièrement indiqué pour le broyage de sarments, maïs, herbe, broussailles, paille et de nombreux autres végétaux. Il est conçu notamment pour travailler dans les vergers et les plantations en rangées grâce à sa compacité, à son encombrement réduit et à ses carter étroits.

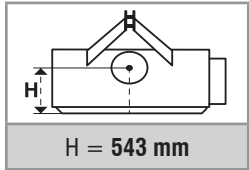

Fiancata inclinata
Side inclined
Geneigte Seite
Hombro máquina inclinada
Inclinée côte



mod.	cod.	cod.	HP	rpm/min	type	nr (type)	cm	kg
TFG 850 *	1002697	1002696	15 - 60	540/1000	T-40	2 (SPB 1500)	102×115×89	320
TFG 1000	1002770	1002767	15 - 60	540/1000	T-40	2 (SPB 1500)	119×115×89	380
TFG 1200	1002783	1002768	20 - 60	540/1000	T-40	2 (SPB 1500)	138×115×89	420

(*) Versione fissa - Fixed version - Feste Version - Versión fija - Version fixe

Di serie	Standard equipment	Serienmässig	Estándar	De série
<ul style="list-style-type: none"> Scatola di trasmissione con ruota libera PTO 1 3/8" Z6 Rotore con sistema di taglio elicoidale Spostamento su barre cromate Spostamento laterale meccanico Doppia fila di pettini rompitori Slitte d'appoggio regolabili in altezza Carter stretto Rullo ozioso posteriore regolabile in altezza (140 mm) Raschiafango per pulizia rullo ozioso Scarico anteriore rullo ozioso Cofano apribile (solo per ispezione) Protezione anteriore a bandinelle Protezioni antinfortunistiche conformi alla normativa CE 	<ul style="list-style-type: none"> Gearbox with freewheel clutch PTO 1 3/8" Z6 Rotor with helical cutting system Side shift on chrome bars Mechanical side shift Double row counter-blades Height-adjustable skids Narrow belt guard Rear levelling roller height adjustable (140 mm) Scraper for rear levelling roller Discharge of the material over the levelling roller Opening hood (for inspection only) Front protection with metal flaps Protective equipment as per EC safety rules 	<ul style="list-style-type: none"> Getriebe mit integriertem Freilauf PTO 1 3/8" Z6 Spiralrotor Seitenverschiebung über Chromstangen Mechanische Seitenverschiebung 2 Reihen Gegenschneide Höhenverstellbare Stützkufen Schmalere Keilriemenschutz Hinterer Stützwalze höhenverstellbar (140 mm) Walzenabstreifer Entladung des Materials über die Walze Heckhaube (darf nur für Wartungsarbeiten geöffnet werden) Frontschutz mit Metallklappen Unfallschutz nach EU-Vorschriften 	<ul style="list-style-type: none"> Caja de engranajes con rueda libre TDF 1 3/8" Z6 Rotor con sistema de corte helicoidal Desplazamiento sobre tubo cromado Desplazamiento lateral mecánico Doble fila de rompedores Patines de apoyo regulable en altura Carter angosto Rodillo nivelador trasero (140 mm), con regulación en altura Limpiador montado en el rodillo nivelador trasero Descarga anterior al rodillo nivelador Portón trasero aperturable (solo para inspección) Protección delantera mediante placas metálicas Protecciones de seguridad de acuerdo con la norma CE 	<ul style="list-style-type: none"> Boîtier de transmission avec roue libre PDF 1 3/8" Z6 Rotor avec système de coupe hélicoïdal Déplacement avec barre chromée Déport latéral mécanique Double rangée de peignes Patins d'appui réglables en hauteur Carter étroit Rouleau d'appui arrière réglable en hauteur (140 mm) Racleur pour le rouleau d'appui Ejection devant le rouleau d'appui Capot ouvrant (pour inspection seulement) Protection avant avec volets métalliques Protections contre les accidents aux normes CE

TFG	MULCHER MEDIUM DUTY WITH COMPACT DESIGN
TFG	MULCHGERÄTE: MITTELSCHWERE AUSFÜHRUNG MIT SCHMALEM KASTEN
TFG	TRITURADORA DE HIERBA Y SARMIENTOS CON TAMAÑO COMPACTO
TFG	BROYEUR AVEC CARTER PROTECTION COURROIES ÉTROIT



ORIGINAL MADE IN ITALY

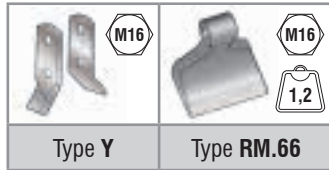
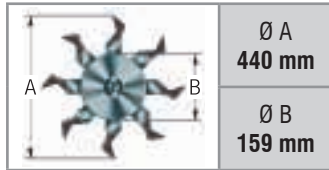

Sistema di taglio elicoidale
Helical cutting system
Spiralrotor
Sistema de corte helicoidal
Système de coupe hélicoïdal



MOD	MOVEMENT MACHINE					WORKING WIDTH	Standard		On request
	cm		cm		cm		nr	nr	
TFG 850	52	50	--	--	--	85	20	10	8
TFG 1000	69	50	39	80	30	100	24	12	9
TFG 1200	69	69	39	99	30	120	32	16	10

cod.	A richiesta	On request	Auf Anfrage	Opcionales	Sur demande
5130003	Cardano T-40	PTO shaft T-40	Gelenkwelle T-40	Cardán T-40	Cardan T-40
2050010	Gruppo spost. idr. 30 cm	Hydraulic side shift 30 cm	Hydraulische Verschiebung 30 cm	Kit desplazador hidr. 30 cm	Groupe de dépl. lat. 30 cm
5210292	Aste di raccolta sarmenti	Twig rakes	Holzaufnahmezinken	Astas de cosecha	Tiges de ramassage
2050005	Kit ruote posteriori in gomma sterzanti	Rear rubber steering wheels kit	Satz hintere Gummilenkräder	Kit de ruedas traseras, en goma, direccionales	Kit roues arrière directrices en caoutchouc
5228867	Lam. antiusura ant. TFG 850	Front anti-wear plate TFG 850	Verschleißplatte TFG 850	Placa anti desgaste del. TFG 850	Plaque avant anti-usure TFG 850
5227908	Lam. antiusura ant. TFG 1000	Front anti-wear plate TFG 1000	Verschleißplatte TFG 1000	Placa anti desgaste del. TFG 1000	Plaque avant anti-usure TFG 1000
5227909	Lam. antiusura ant. TFG 1200	Front anti-wear plate TFG 1200	Verschleißplatte TFG 1200	Placa anti desgaste del. TFG 1200	Plaque avant anti-usure TFG 1200

cod.	Ricambi	Spare parts	Ersatzteile	Recambios	Pièces de rechange
5354044	Cinghia SPB-1500	Cug belt SPB-1500	Keilriemen SPB-1500	Correa SPB-1500	Courroie SPB-1500
5315446	Vite M16 per utensile	M16 screw for tool	M16 Schraube für Werkzeug	Tornillo M16 para herramienta	Vis M16 pour outil
5323017	Dado M16 per utensile	M16 nut for tool	M16 Mutter für Werkzeug	Tuerca M16 para herramienta	Ecrou M16 pour outil
5350121	Mazza RM.66	Hammer RM.66	Hammer RM.66	Martillo RM.66	Marteau RM.66
5350127	Coltello "Y"	"Y" blade	"Y" Messer	Cuchilla "Y"	Couteau "Y"
2020089	Scatola trasmissione	Gear box	Getriebe	Caja de engranajes	Boîtier de transmission



cod. 2050005
On request
Kit ruote posteriori
Rear wheel kit
Satz hinterräder
Kit ruedas posteriores
Kit roues arriere

Impiego **Use** **Verwendung** **Uso** **Utilisation**

La trinciaerba e sarmenti TFA si presta in modo ottimale per la triturazione di sarmenti, erba, sterpaglie, paglia, e molto altro. È dotata di una robusta struttura in acciaio con fiancate arrotondate, senza spigoli e senza componentistica esterna, che consentono di lavorare a ridosso di piante senza causare alterazioni della corteccia.

The TFA mulcher is ideal for mulching twigs, grass, brushwood, hay and more besides. It boasts a robust steel frame with rounded side panels, no sharp edges and no moving external parts. It can therefore be used right up to crops and trees without causing damage.

Das TFA Mulchgerät eignet sich ideal zum Zerkleinern von Gehölzschnitt, Gras und Reisig, insbesondere in Weinbergen und Obstplantagen. Die Maschine ist mit einer robusten Stahlkonstruktion mit abgerundeten Seiten ausgestattet. Es kann daher bis hin zu Feldfrüchten und Bäumen eingesetzt werden, ohne Schaden anzurichten.

La trituradora de hierba y sarmientos TFA es excelente para triturar sarmientos, hierba, malezas, paja y mucho más. Está equipada con una estructura robusta de acero con laterales redondeados, sin bordes ni componentes externos, que permite trabajar cerca de las plantas sin dañar la corteza.

Le broyeur d'herbe et de sarments TFA est particulièrement indiqué pour le broyage de sarments, herbe, broussailles, paille et de nombreux autres végétaux. Il est muni d'une structure robuste en acier avec joues latérales arrondies, sans arêtes vives et sans composants externes, qui permettent de travailler contre les plantes sans abîmer l'écorce.



Fiancata arrotondata
Rounded shoulder
Mit gerundeter Seite
Lateral con borde redondeado
Flanc arrondi

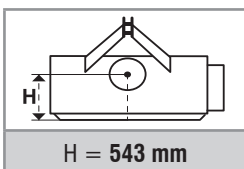

mod.	cod.	cod.	HP	rpm/min	type	nr (type)	cm	kg
TFA 1300	1002889	1002890	30 - 70	540/1000	T-40	2 (SPB 1525)	144×117×93	420
TFA 1400	1002775	1002771	30 - 70	540/1000	T-40	3 (SPB 1525)	156×117×93	450
TFA 1600	1002776	1002772	40 - 70	540/1000	T-50	3 (SPB 1525)	175×117×93	510
TFA 1800	1002777	1002773	40 - 70	540/1000	T-50	4 (SPB 1525)	194×117×93	550
TFA 2000	1002778	1002774	50 - 90	540/1000	T-60	4 (SPB 1525)	213×117×93	620
TFA 2200	1002779	1002780	60 - 90	540/1000	T-60	5 (SPB 1525)	235×117×93	690

Di serie	Standard equipment	Serienmässig	Estándar	De série
<ul style="list-style-type: none"> Scatola di trasmissione con ruota libera PTO 1 3/8" Z6 Rotore con sistema di taglio elicoidale Spostamento su barre cromate Spostamento laterale meccanico Doppia fila di pettini rompitori Slitte d'appoggio regolabili in altezza Fiancata destra con bordi arrotondati Rullo ozioso posteriore regolabile in altezza (194 mm) Raschiafango per pulizia rullo ozioso Scarico anteriore rullo ozioso Cofano apribile (solo per ispezione) Protezione anteriore a bandinelle Protezioni antinfortunistiche conformi alla normativa CE 	<ul style="list-style-type: none"> Gearbox with freewheel clutch PTO 1 3/8" Z6 Rotor with helical cutting system Side shift on chrome bars Mechanical side shift Double row counter-blades Height-adjustable skids Right side rounded shoulder Rear levelling roller height adjustable (194 mm) Scraper for rear levelling roller Discharge of the material over the levelling roller Opening hood (for inspection only) Front protection with metal flaps Protective equipment as per EC safety rules 	<ul style="list-style-type: none"> Getriebe mit integriertem Freilauf PTO 1 3/8" Z6 Spiralrotor Seitenverschiebung über Chromstangen Mechanische Seitenverschiebung 2 Reihen Gegenschneide Höhenverstellbare Stützkufen Abgerundete rechte Seitenecke Hintere Stützwalze höhenverstellbar (194 mm) Walzenabstreifer Entladung des Materials über die Walze Heckhaube (darf nur für Wartungsarbeiten geöffnet werden) Frontschutz mit Metallklappen Unfallschutz nach EU-Vorschriften 	<ul style="list-style-type: none"> Caja de engranajes con rueda libre TDF 1 3/8" Z6 Rotor con sistema de corte helicoidal Desplazamiento sobre tubo cromado Desplazamiento lateral mecánico Doble fila de rompedores Patines de apoyo regulable en altura Lateral derecho con borde redondeado Rodillo nivelador trasero (194 mm), con regulación en altura Limpiador montado en el rodillo nivelador trasero Descarga anterior al rodillo nivelador Portón trasero aperturable (solo para inspección) Protección delantera mediante placas metálicas Protecciones de seguridad de acuerdo con la norma CE 	<ul style="list-style-type: none"> Boîtier de transmission avec roue libre PDF 1 3/8" Z6 Rotor avec système de coupe hélicoïdal Déplacement avec barre chromée Déport latéral mécanique Double rangée de peignes Patins d'appui réglables en hauteur Côté latéral droit arrondi Rouleau d'appui arrière réglable en hauteur (194 mm) Racleur pour le rouleau d'appui Ejection devant le rouleau d'appui Capot ouvrant (pour inspection seulement) Protection avant avec volets métalliques Protections contre les accidents aux normes CE

TFA	MULCHER MEDIUM DUTY WITH ROUNDED RIGHT SIDE
TFA	MULCHGERÄTE: MITTELSCHWERE AUSFÜHRUNG MIT GERUNDETER SEITE
TFA	TRITURADORA DE HIERBA Y SARMIENTOS CON LATERALES REDONDEADOS
TFA	BROYEUR AVEC CÔTÉ ARRONDI

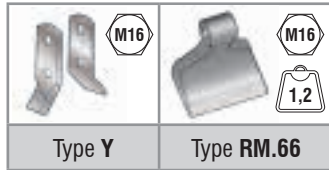
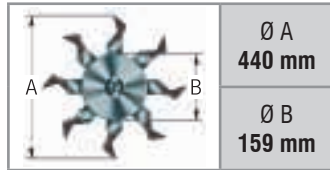

Sistema di taglio elicoidale
Helical cutting system
Spiralrotor
Sistema de corte helicoidal
Système de coupe hélicoïdal



MOD	MOVEMENT MACHINE				WORKING WIDTH	Standard		On request	
	cm		cm			cm	nr	nr	nr
TFA 1300	84	60	54	90	30	130	32	16	11
TFA 1400	84	72	54	102	30	140	36	18	12
TFA 1600	94	81	54	121	40	160	40	20	14
TFA 1800	94	100	54	140	40	180	48	24	16
TFA 2000	111	102	71	142	40	200	48	24	18
TFA 2200	131	104	91	144	40	220	56	28	19

cod.	A richiesta	On request	Auf Anfrage	Opcionales	Sur demande
5130003	Cardano T-40	PTO shaft T-40	Gelenkwelle T-40	Cardán T-40	Cardan T-40
5130005	Cardano T-50	PTO shaft T-50	Gelenkwelle T-50	Cardán T-50	Cardan T-50
5130009	Cardano T-60	PTO shaft T-60	Gelenkwelle T-60	Cardán T-60	Cardan T-60
2050010	Gruppo spost. idr. 30 cm	Hydraulic side shift 30 cm	Hydraulische Verschiebung 30 cm	Kit desplazador hidr. 30 cm	Groupe de dépl. lat. 30 cm
2050011	Gruppo spost. idr. 40 cm	Hydraulic side shift 40 cm	Hydraulische Verschiebung 40 cm	Kit desplazador hidr. 40 cm	Groupe de dépl. lat. 40 cm
5210292	Aste di raccolta sarmenti	Twig rakes	Holzaufnahmezinken	Astas de cosecha	Tiges de ramassage
2050005	Kit ruote posteriori in gomma sterzanti	Rear rubber steering wheels kit	Satz hintere Gummilenkräder	Kit de ruedas traseras, en goma, direccionales	Kit roues arrière directrices en caoutchouc
2050856	Kit ruote anteriori in acciaio fisse	Fixed steel front wheels	Satz Fronträder	Kit de ruedas delanteras, en hierro, fijas	Kit roues antérieures fixes en acier
5227909	Lam. antiusura ant. TFA 1300	Front anti-wear plate TFA 1300	Verschleißplatte TFA 1300	Placa anti desgaste del. TFA 1300	Plaque avant anti-usure TFA 1300
5223636	Lam. antiusura ant. TFA 1400	Front anti-wear plate TFA 1400	Verschleißplatte TFA 1400	Placa anti desgaste del. TFA 1400	Plaque avant anti-usure TFA 1400
5223637	Lam. antiusura ant. TFA 1600	Front anti-wear plate TFA 1600	Verschleißplatte TFA 1600	Placa anti desgaste del. TFA 1600	Plaque avant anti-usure TFA 1600
5223638	Lam. antiusura ant. TFA 1800	Front anti-wear plate TFA 1800	Verschleißplatte TFA 1800	Placa anti desgaste del. TFA 1800	Plaque avant anti-usure TFA 1800
5223639	Lam. antiusura ant. TFA 2000	Front anti-wear plate TFA 2000	Verschleißplatte TFA 2000	Placa anti desgaste del. TFA 2000	Plaque avant anti-usure TFA 2000
5223640	Lam. antiusura ant. TFA 2200	Front anti-wear plate TFA 2200	Verschleißplatte TFA 2200	Placa anti desgaste del. TFA 2200	Plaque avant anti-usure TFA 2200

cod.	Ricambi	Spare parts	Ersatzteile	Recambios	Pièces de rechange
5354071	Cinghia SPB-1525	Cug belt SPB-1525	Keilriemen SPB-1525	Correa SPB-1525	Courroie SPB-1525
5315446	Vite M16 per utensile	M16 screw for tool	M16 Schraube für Werkzeug	Tornillo M16 para herramienta	Vis M16 pour outil
5323017	Dado M16 per utensile	M16 nut for tool	M16 Mutter für Werkzeug	Tuerca M16 para herramienta	Ecrou M16 pour outil
5350121	Mazza RM.66	Hammer RM.66	Hammer RM.66	Martillo RM.66	Marteau RM.66
5350127	Coltello "Y"	"Y" blade	"Y" Messer	Cuchilla "Y"	Couteau "Y"
2020025	Scatola trasm. 1400/1600/1800	Gear box 1400/1600/1800	Getriebe 1400/1600/1800	Caja de engran.1400/1600/1800	Boîtier de transm. 1400/1600/1800
2020015	Scatola trasmissione TFA 2000	Gear box TFA 2000	Getriebe TFA 2000	Caja de engranajes TFA 2000	Boîtier de transm. TFA 2000
2020088	Scatola trasmissione TFA 2200	Gear box TFA 2200	Getriebe TFA 2200	Caja de engranajes TFA 2200	Boîtier de transm. TFA 2200



cod. 2050005
On request
Kit ruote posteriori
Rear wheel kit
Satz hinterräder
Kit ruedas posteriores
Kit roues arriere



cod. 2050856
On request
Kit ruote anteriori
Fixed steel front wheels
Satz Fronträder
Kit de ruedas delanteras
Kit roues antérieures fixes

Impiego

La trincia TFO è indicata per l'utilizzo in vigneti, frutteti e altre colture disposte a filari poiché consente di lavorare con agilità ben oltre la carreggiata del trattore. La fiancata arrotondata permette all'operatore di avvicinarsi alle piante senza danneggiarle.

Use

The TFO mulcher is suitable for vineyards, orchards and other crops arranged in rows because it allows you to work with agility well beyond the track of the tractor. The rounded side, which derives from the TFA mulcher, allows the operator to approach the plants without damaging them.

Verwendung

Das TFO-Mulchgerät ist für den Einsatz in Weinbergen, Obstplantagen und anderen Reihenkulturen geeignet, da es ein wendiges Arbeiten weit über die Spurbreite des Traktors hinaus ermöglicht. Die abgerundete Seite, die vom TFA-Mulcher abgeleitet ist, ermöglicht es dem Bediener, nahe an die Pflanzen heranzukommen, ohne sie zu beschädigen.

Uso

Desbrozadora-trituradora de gran desplazamiento. Desplazamiento mediante paralelas accionadas hidráulicamente. Especialmente diseñada para poder acceder a las partes inferiores de los árboles, debido a su gran desplazamiento lateral. Lateral redondeado para evitar el daño de los árboles como del fruto.

Utilisation

Le broyeur TFO convient à une utilisation dans les vignes, les vergers et autres cultures disposées en rangées car il vous permet de travailler avec agilité bien au-delà de la voie du tracteur. Le côté arrondi permet à l'opérateur de s'approcher des plantes sans les endommager.



Di serie
Standard
Serienmässig
Estandar
De série

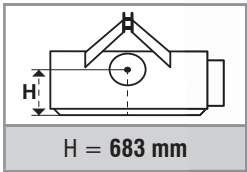

mod.	cod.	cod.	HP	rpm/min	type	nr (type)	cm	kg
TFO 1600	1003817	1003816	40 - 70	540/1000	T-60	3 (XPB 1600)	182×165×105	560
TFO 1800	1003819	1003818	40 - 70	540/1000	T-60	4 (XPB 1600)	201×165×105	625
TFO 2000	1003821	1003820	50 - 70	540/1000	T-60	4 (XPB 1600)	220×165×105	685
TFO 2200	1003823	1003822	60 - 90	540/1000	T-60	5 (XPB 1600)	240×165×105	750
TFO 2400	1003825	1003824	60 - 90	540/1000	T-60	5 (XPB 1600)	260×165×105	815

Di serie

- Scatola di trasmissione con ruota libera PTO 1 3/8" Z6
- Cardano
- Rotore con sistema di taglio elicoidale
- Spostamento idraulico a parallelogramma
- Doppia fila di pettini rompitori
- Slitte d'appoggio regolabili in altezza
- Fiancata destra con bordi arrotondati
- Rullo ozioso posteriore regolabile in altezza (194 mm)
- Raschiafango per pulizia rullo ozioso
- Scarico anteriore rullo ozioso
- Cofano apribile (solo per ispezione)
- Protezione anteriore a bandinelle
- Protezioni antinfortunistiche conformi alla normativa CE

Standard equipment

- Gearbox with freewheel clutch PTO 1 3/8" Z6
- PTO drive shaft
- Rotor with helical cutting system
- Hydraulic parallelogram shift
- Double row counter-blades
- Height-adjustable skids
- Right side rounded shoulder
- Rear levelling roller height adjustable (194 mm)
- Scraper for rear levelling roller
- Discharge of the material over the levelling roller
- Opening hood (for inspection only)
- Front protection with metal flaps
- Protective equipment as per EC safety rules

Serienmässig

- Getriebe mit integriertem Freilauf PTO 1 3/8" Z6
- Gelenkwelle
- Spiralrotor
- Hydraulische Parallelogramm-Seitenverschiebung
- 2 Reihen Gegenschneide
- Höhenverstellbare Stützkufen
- Abgerundete rechte Seitenecke
- Hintere Stützwalze höhenverstellbar (194 mm)
- Walzenabstreifer
- Entladung des Materials über die Walze
- Heckhaube (darf nur für Wartungsarbeiten geöffnet werden)
- Frontschutz mit Metallklappen
- Unfallschutz nach EU-Vorschriften

Estandar

- Caja de engranajes con rueda libre TDF 1 3/8" Z6
- Transmisión cardanica
- Rotor con sistema de corte helicoidal
- Desplazamiento hidráulico paralelogramo
- Doble fila de rompedores
- Patines de apoyo regulable en altura
- Lateral derecho con borde redondeado
- Rodillo nivelador trasero (194 mm), con regulación en altura
- Limpiador montado en el rodillo nivelador trasero
- Descarga anterior al rodillo nivelador
- Portón trasero aperturable (solo para inspección)
- Protección delantera mediante placas metálicas
- Protecciones de seguridad de acuerdo con la norma CE

De série

- Boîtier de transmission avec roue libre PDF 1 3/8" Z6
- Cardan
- Rotor avec système de coupe hélicoidal
- Déplacement hydraulique avec parallélogramme
- Double rangée de peignes
- Patins d'appui réglables en hauteur
- Côté latéral droit arrondi
- Rouleau d'appui arrière réglable en hauteur (194 mm)
- Racleur pour le rouleau d'appui
- Ejection devant le rouleau d'appui
- Capot ouvrant (pour inspection seulement)
- Protection avant avec volets métalliques
- Protections contre les accidents aux normes CE

TFO	PARALLELOGRAM MULCHER WITH HYDRAULIC SHIFT
TFO	MULCHGERÄTE MIT HYDRAULISCHER PARALLELOGRAMM-SEITENVERSCHIEBUNG
TFO	DESBROZADORA - TRITURADORA DE GRAN DESPLAZAMIENTO
TFO	BROYEUR D'HERBE ET DE SARMENTS AVEC DEPLACEMENT HYDRAULIQUE



ORIGINAL MADE IN ITALY

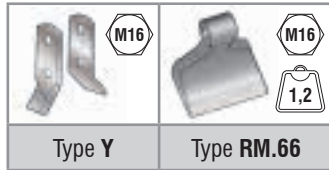
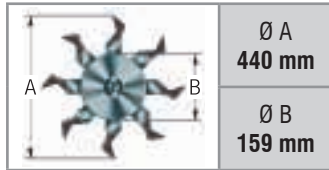

Sistema di taglio elicoidale
Helical cutting system
Spiralrotor
Sistema de corte helicoidal
Système de coupe hélicoïdal



MOD	MOVEMENT MACHINE										WORKING WIDTH		Standard		On request	
	cm		cm		A	B	C	D	E	cm	nr	nr	nr			
TFO 1600	109	73	16	166	166	166	182	109	166	160	40	20	14			
TFO 1800	109	92	16	185	185	166	201	109	166	180	48	24	16			
TFO 2000	109	111	16	204	204	166	220	109	166	200	48	24	18			
TFO 2200	109	130	16	223	223	166	239	109	166	220	56	28	19			
TFO 2400	109	149	16	242	242	166	258	109	166	240	64	32	21			

cod.	A richiesta	On request	Auf Anfrage	Opcionales	Sur demande
5210292	Aste di raccolta sarmenti	Twig rakes	Holzaufnahmezinken	Astas de cosecha	Tiges de ramassage
2050005	Kit ruote posteriori in gomma sterzanti	Rear rubber steering wheels kit	Satz hintere Gummilenkräder	Kit de ruedas traseras, en goma, direccionales	Kit roues arrière directrices en caoutchouc
5223637	Lam. antiusura ant. TFO 1600	Front anti-wear plate TFO 1600	Verschleißplatte TFO 1600	Placa anti desgaste del. TFO 1600	Plaque avant anti-usure TFO 1600
5223638	Lam. antiusura ant. TFO 1800	Front anti-wear plate TFO 1800	Verschleißplatte TFO 1800	Placa anti desgaste del. TFO 1800	Plaque avant anti-usure TFO 1800
5223639	Lam. antiusura ant. TFO 2000	Front anti-wear plate TFO 2000	Verschleißplatte TFO 2000	Placa anti desgaste del. TFO 2000	Plaque avant anti-usure TFO 2000
5223640	Lam. antiusura ant. TFO 2200	Front anti-wear plate TFO 2200	Verschleißplatte TFO 2200	Placa anti desgaste del. TFO 2200	Plaque avant anti-usure TFO 2200
5230768	Lam. antiusura ant. TFO 2400	Front anti-wear plate TFO 2400	Verschleißplatte TFO 2400	Placa anti desgaste del. TFO 2400	Plaque avant anti-usure TFO 2400

cod.	Ricambi	Spare parts	Ersatzteile	Recambios	Pièces de rechange
5354067	Cinghia XPB-1600	Cug belt XPB-1600	Keilriemen XPB-1600	Correa XPB-1600	Courroie XPB-1600
5315446	Vite M16 per utensile	M16 screw for tool	M16 Schraube für Werkzeug	Tornillo M16 para herramienta	Vis M16 pour outil
5323017	Dado M16 per utensile	M16 nut for tool	M16 Mutter für Werkzeug	Tuerca M16 para herramienta	Ecrou M16 pour outil
5350121	Mazza RM.66	Hammer RM.66	Hammer RM.66	Martillo RM.66	Marteau RM.66
5350127	Coltello "Y"	"Y" blade	"Y" Messer	Cuchilla "Y"	Couteau "Y"
2020025	Scatola trasm. 1600/1800/2000	Gear box 1600/1800/2000	Getriebe 1600/1800/2000	Caja de engran.1600/1800/2000	Boîtier de transm. 1600/1800/2000
2020015	Scatola trasmissione TFA 2200	Gear box TFA 2200	Getriebe TFA 2200	Caja de engranajes TFA 2200	Boîtier de transm. TFA 2200
2020088	Scatola trasmissione TFA 2400	Gear box TFA 2400	Getriebe TFA 2400	Caja de engranajes TFA 2400	Boîtier de transm. TFA 2400



Impiego Use Verwendung Uso Utilisation

La trincia TDR viene utilizzata principalmente su vigneti, vivai e orticoltura. Grazie alle fiancate ribassate permette di trinciare anche sotto colture con fronde basse senza ammaccare i frutti o spezzare i rami. Si presta in modo ottimale per la triturazione di sarmenti, erba e molto altro.

The TDR flail mower is mainly used on vineyards, nurseries and horticulture. Thanks to the lowered sides it allows to chop even under crops with base fronds without denting the fruits or breaking the branches. It is ideal for shredding prunings, grass and much more controlled by a conical oil bath pair.

Das TDR Mulchgerät wird hauptsächlich in Weinbergen, Obstgärten und Baumschulen eingesetzt. Dank seiner sowohl niedrigen als auch abgerundeten Seiten ermöglicht es das Häckseln auch unter Kulturen ohne die Früchte einzudellen oder die Äste zu brechen. Es ist ideal zum Zerkleinern von Schnittholz, Gras und vielem mehr.

El cortacésped TDR se utiliza principalmente en viñedos, viveros y horticultura. Gracias a los lados bajos permite cortar incluso los cultivos con bases sin dientes, los frutos o las ramas. Es ideal para triturar podas, césped y mucho más.

La tondeuse à fléaux TDR est principalement utilisée dans les vignobles, les pépinières et l'horticulture. Grâce aux côtés abaissés, il permet de couper même les cultures avec des bases sans blesser le fruits ni casser les branches. Il est idéal pour déchiqeter les émondes, l'herbe et bien plus encore.



Di serie
Standard
Serienmässig
Estándar
De série

L'immagine della macchina è indicativa. Gli utensili e gli accessori sono a richiesta. – The picture of the machine is indicative. Tools and accessories are on request.



mod.	cod.	cod.	HP	rpm/min	type	nr (type)	cm	kg
TDR 1400	1002987	1002981	35 - 70	540/1000 *	T-60+RL	(4) SPB 1525	140×169×102	680
TDR 1600	1002988	1002982	40 - 70	540/1000 *	T-60+RL	(4) SPB 1525	160×169×102	750
TDR 1800	1002989	1002983	50 - 70	540/1000 *	T-60+RL	(6) SPB 1525	180×169×102	820
TDR 2000	1002990	1002984	60 - 90	540/1000 *	T-70+RL	(6) SPB 1525	200×169×102	890
TDR 2200	1002991	1002985	70 - 90	540/1000 *	T-70+RL	(6) SPB 1525	220×169×102	960
TDR 2400	1002992	1002986	80 - 100	540/1000 *	T-70+RL	(6) SPB 1525	240×169×102	1030
TDR 2600	1003000	1002997	90 - 130	540/1000 *	T-80+RL	(8) SPB 1525	260×169×102	1100
TDR 2800	1003001	1002998	90 - 130	540/1000 *	T-80+RL	(8) SPB 1525	280×169×102	1170
TDR 3000	1003002	1002999	110 - 150	540/1000 *	T-80+RL	(8) SPB 1525	300×169×102	1240

(*) 540 rpm/min standard, 1000 rpm/min con scatola dedicata - 1000 rpm/min with dedicated box - 1000 rpm/min Mit dedizierter Box - 1000 rpm/min con caja dedicada - 1000 rpm/min avec boîte dédiée

Di serie	Standard equipment	Serienmässig	Estándar	De série
<ul style="list-style-type: none"> Telaio con doppia lamiera Scatola di trasmissione senza ruota libera PTO 1 3/8" Z6 Cardano con ruota libera Rotore con sistema di taglio elicoidale Spostamento su barre cromate Spostamento laterale meccanico Singola fila di pettini rompitori Piastre salvabordi Fiancate con bordi arrotondati Rullo ozioso posteriore regolabile in altezza (194 mm) Raschiafango per pulizia rullo ozioso Scarico anteriore rullo ozioso Protezione anteriore a bandinelle e catene Kit ruote anteriori Protezioni antinfortunistiche conformi alla normativa CE 	<ul style="list-style-type: none"> Double skinned frame Gearbox without freewheel clutch PTO 1 3/8" Z6 PTO drive shaft with freewheel clutch Rotor with helical cutting system Side shift on chrome bars Mechanical side shift Single row counter-blades Side guards Sides with rounded shoulders Rear levelling roller height adjustable (194 mm) Scraper for rear levelling roller Discharge of the material over the levelling roller Front protection with metal flaps and chains Front wheels kit Protective equipment as per EC safety rules 	<ul style="list-style-type: none"> Doppelwandiger Rahmen Getriebe ohne Freilauf PTO 1 3/8" Z6 Gelenkwelle mit Freilauf Spiralrotor Seitenverschiebung über Chromstangen Mechanische Seitenverschiebung 1 Reihe Gegenschneide Platten-Kantenschutz Abgerundete Seiten Hinterer Stützwalze höhenverstellbar (194 mm) Walzenabstreifer Entladung des Materials über die Walze Frontschutz mit Metallklappen und Ketten Satz Fronträder Unfallschutz nach EU-Vorschriften 	<ul style="list-style-type: none"> Interior del cuerpo de maquina, con doble chapa Caja de engranajes sin rueda libre TDF 1 3/8" Z6 Transmisión cardanica con rueda libre Rotor con sistema de corte helicoidal Desplazamiento sobre tubo cromado Desplazamiento lateral mecánico Rompedor Placa protección bordes Lados con bordes redondeados Rodillo nivelador trasero (194 mm), con regulación en altura Limpiador montado en el rodillo nivelador trasero Descarga anterior al rodillo nivelador Protección delantera a placas metálicas y cadenas Kit de ruedas delanteras Protecciones de seguridad de acuerdo con la norma CE 	<ul style="list-style-type: none"> Caisson renforcé par blindage interne Boîtier de transmission sans roue libre PDF 1 3/8" Z6 Cardan avec roue libre Rotor avec système de coupe hélicoïdal Déplacement avec barre chromée Déport latéral mécanique Simple rangée de peignes Plaques de protection des bords Côtés latéraux arrondis Rouleau d'appui arrière réglable en hauteur (194 mm) Racleur pour le rouleau d'appui Ejection devant le rouleau d'appui Protection avant avec volets métalliques et chaînes Kit roues antérieures Protections contre les accidents aux normes CE

TDR	MULCHER MEDIUM DUTY WITH DOUBLE ROTOR
TDR	MULCHGERÄTE: MITTELSCHWERE AUSFÜHRUNG MIT DOPPELROTOR
TDR	TRITURADORA DE HIERBA Y SARMIENTOS CON DOBLE RODILLO
TDR	BROYEUR D'HERBE ET DE SARMENTS AVEC DOUBLE ROTOR



ORIGINAL MADE IN ITALY

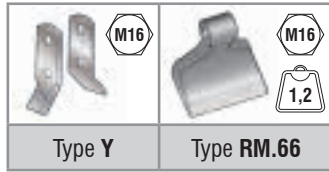
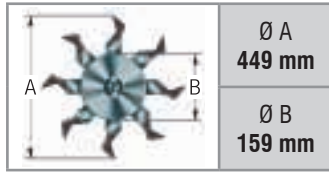

Sistema di taglio elicoidale
Helical cutting system
Spiralrotor
Sistema de corte helicoidal
Système de coupe hélicoïdal

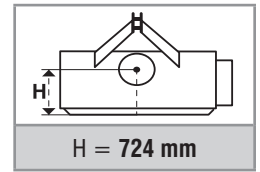

MOD	MOVEMENT MACHINE					WORKING WIDTH	Standard		On request
	cm		cm		cm		nr	nr	nr
TDR 1400	85	55	55	85	30	140	40	20	11
TDR 1600	95	65	65	95	30	160	48	24	13
TDR 1800	105	75	75	105	30	180	48	24	15
TDR 2000	120	80	80	120	40	200	56	28	17
TDR 2200	130	90	90	130	40	220	56	28	18
TDR 2400	140	100	100	140	40	240	64	32	20
TDR 2600	150	110	110	150	40	260	72	36	22
TDR 2800	160	120	120	160	40	280	72	36	23
TDR 3000	170	130	130	170	40	300	80	40	25

cod.	A richiesta	On request	Auf Anfrage	Opcionales	Sur demande
2050010	Gruppo spost. idr. 30 cm	Hydraulic side shift 30 cm	Hydraulische Verschiebung 30 cm	Kit desplazador hidr. 30 cm	Groupe de dépl. lat. 30 cm
2050011	Gruppo spost. idr. 40 cm	Hydraulic side shift 40 cm	Hydraulische Verschiebung 40 cm	Kit desplazador hidr. 40 cm	Groupe de dépl. lat. 40 cm
5210292	Aste di raccolta sarmenti	Twig rakes	Holzaufnahmezinken	Astas de cosecha	Tiges de ramassage
2050679	Kit ruote posteriori in acciaio fisse	Fixed steel rear wheels kit	Satz feste Stahl-Hinterräder	Kit de ruedas traseras, en hierro, fijas	Kit roues arrière fixes en acier
2050680	Kit slitte antiusura	Anti-wear slide kit	Anti-wear slide kit	Kit de deslizamiento antidesgaste	Kit coulissant anti-usure

cod.	Ricambi	Spare parts	Ersatzteile	Recambios	Pièces de rechange
5130052	Cardano T-60+RL	PTO shaft T-60+RL	Gelenkwelle T-60+RL	Cardán T-60+RL	Cardan T-60+RL
5130053	Cardano T-70+RL	PTO shaft T-70+RL	Gelenkwelle T-70+RL	Cardán T-70+RL	Cardan T-70+RL
5130054	Cardano T-80+RL	PTO shaft T-80+RL	Gelenkwelle T-80+RL	Cardán T-80+RL	Cardan T-80+RL
5354071	Cinghia SPB-1525	Cug belt SPB-1525	Keilriemen SPB-1525	Correa SPB-1525	Courroie SPB-1525
5315446	Vite M16 per utensile	M16 screw for tool	M16 Schraube für Werkzeug	Tornillo M16 para herramienta	Vis M16 pour outil
5323017	Dado M16 per utensile	M16 nut for tool	M16 Mutter für Werkzeug	Tuerca M16 para herramienta	Ecrou M16 pour outil
5350121	Mazza RM.66	Hammer RM.66	Hammer RM.66	Martillo RM.66	Marteau RM.66
5350127	Coltello "Y"	"Y" blade	"Y" Messer	Cuchilla "Y"	Couteau "Y"
2020159	Scatola trasmissione 540 giri/min.	Gear box 540 rpm	Getriebe 540 U/min.	Caja de engranajes 540 rpm	Boîtier de transm. 540 tours/min.
2020161	Scatola trasmissione 1000 giri/min.	Gear box 1000 rpm	Getriebe 1000 U/min.	Caja de engranajes 1000 rpm	Boîtier de transm. 1000 tours/min.

All'ordine specificare se la macchina lavora frontale o posteriore, n. di giri e senso di rotazione della PTO

To order, specify whether the machine works front or rear, n. of revolutions and direction of rotation of the PTO

Geben Sie bei der Bestellung an, ob die Maschine vorne oder hinten arbeitet, n. Drehzahl und Drehrichtung der Zapfwelle

Al ordenar, especifique si la máquina funciona en la parte delantera o trasera, n. de revoluciones y sentido de giro de la TDF

Pour commander spécifiez si la machine fonctionne à l'avant ou à l'arrière, n. de révolutions et sens de rotation de la prise de force

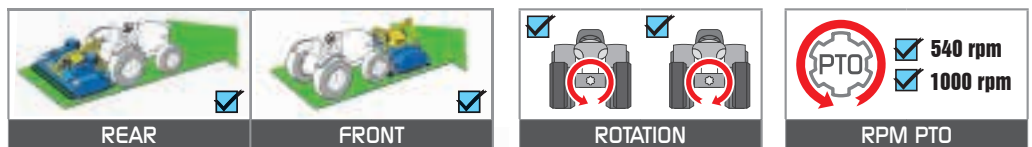

Impiego

La trinciaerba TSP si presta in modo ottimale per la triturazione di erbe, sterpaglie, paglia e molto altro. La conformazione della struttura trincia permette lo scarico posteriormente al rullo ozioso.

Use

The TSP flail mower is ideal for mulching hay, twigs and more besides. The roller is placed close to the rotor, so it is automatically cleaned by the rotating hammers and the cut material is distributed over the top of the roller.

Verwendung

Das TSP ist optimal zum häckseln von Gras, Gestrüpp, Stroh, Zweigen und viel mehr. Die Walze wird in der Nähe des Rotors platziert, so dass sie automatisch gereinigt wird. Ablage nach der Laufwalze, weniger Kraftbedarf.

Uso

La trituradora-desbrozadora TSP está diseñada para el desbroce de campos, malezas y restos de cosecha. El diseño de esta trituradora permite la descarga del material triturado por la parte posterior del rodillo nivelador trasero.

Utilisation

Le broyeur TSP est particulièrement indiqué pour le broyage de herbe, paille, déchets d'élagage et d'arbustes. La conformation de la structure du broyeur permet le déchargement du matériel derrière le rouleau.

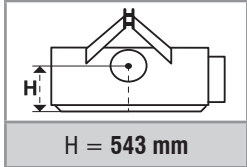

Scarico posteriore al rullo
The cut material is distributed over the top of the roller
Ablage nach der Laufwalze, weniger Kraftbedarf
Descarga detrás del rodillo
Évacuation à l'arrière du rouleau



mod.	cod.	cod.	HP	rpm/min	type	nr (type)	cm	kg
TSP 1400	1002925	1002916	30 - 90	540/1000	T-40	3 (SPB 1525)	163×132×93	490
TSP 1600	1002926	1002917	35 - 90	540/1000	T-50	3 (SPB 1525)	182×132×93	540
TSP 1800	1002927	1002918	40 - 90	540/1000	T-50	4 (SPB 1525)	201×132×93	590
TSP 2000	1002928	1002919	50 - 90	540/1000	T-60	4 (SPB 1525)	220×132×93	640
TSP 2200	1002929	1002920	60 - 90	540/1000	T-60	5 (SPB 1525)	243×132×93	690
TSP 2400	1002930	1002921	60 - 130	540/1000	T-60	5 (SPB 1525)	260×132×93	740
TSP 2600	1002931	1002922	70 - 130	540/1000	T-70	6 (SPB 1525)	280×132×93	790
TSP 2800	1002932	1002923	80 - 150	540/1000	T-70	6 (SPB 1525)	300×132×93	840
TSP 3000	1002933	1002924	90 - 150	540/1000	T-70	6 (SPB 1525)	320×132×93	890

Di serie	Standard equipment	Serienmässig	Estándar	De série
<ul style="list-style-type: none"> Scatola di trasmissione con ruota libera PTO 1 3/8" Z6 Rotore con sistema di taglio elicoidale Spostamento su barre cromate Spostamento laterale meccanico Doppia fila di pettini rompitori Slitte d'appoggio regolabili in altezza Rullo ozioso posteriore regolabile in altezza (194 mm) Scarico posteriore rullo ozioso Protezione posteriore in gomma Protezione anteriore a bandinelle Protezioni antinfortunistiche conformi alla normativa CE 	<ul style="list-style-type: none"> Gearbox with freewheel clutch PTO 1 3/8" Z6 Rotor with helical cutting system Side shift on chrome bars Mechanical side shift Double row counter-blades Height-adjustable skids Rear levelling roller height adjustable (194 mm) Discharge of the material before the levelling roller Rear protection with rubber Front protection with metal flaps Protective equipment as per EC safety rules 	<ul style="list-style-type: none"> Getriebe mit integriertem Freilauf PTO 1 3/8" Z6 Spiralrotor Seitenverschiebung über Chromstangen Mechanische Seitenverschiebung 2 Reihen Gegenschneide Höhenverstellbare Stützkufen Hintere Stützwalze höhenverstellbar (194 mm) Entladung des Materials vor der Walze Hinterer Gummischutz Frontschutz mit Metallklappen Unfallschutz nach EU-Vorschriften 	<ul style="list-style-type: none"> Caja de engranajes con rueda libre TDF 1 3/8" Z6 Rotor con sistema de corte helicoidal Desplazamiento sobre tubo cromado Desplazamiento lateral mecánico Doble fila de rompedores Patines de apoyo regulable en altura Rodillo nivelador trasero (194 mm), con regulación en altura Descarga posterior al rodillo nivelador Protección posterior en goma Protección delantera mediante placas metálicas Protecciones de seguridad de acuerdo con la norma CE 	<ul style="list-style-type: none"> Boîtier de transmission avec roue libre PDF 1 3/8" Z6 Rotor avec système de coupe hélicoïdal Déplacement avec barre chromée Déport latéral mécanique Double rangée de peignes Patins d'appui réglables en hauteur Rouleau d'appui arrière réglable en hauteur (194 mm) Ejection derrière le rouleau d'appui Protection arrière en caoutchouc Protection avant avec volets métalliques Protections contre les accidents aux normes CE

TSP	MULCHER MEDIUM DUTY WITH DISCHARGE BEHIND THE ROLLER
TSP	HECKANBAU MULCHER MIT AUSWURF HINTEN DER WALZE
TSP	TRITURADORA DE HIERBA CON DESCARGA DETRÁS DEL RODILLO
TSP	BROYEUR AVEC SYSTÈME D'ÉVACUATION À L'ARRIÈRE DU ROULEAU



Mod. TSP 1400 / 1600 / 1800 / 2000 / 2200

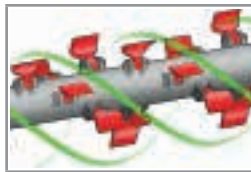
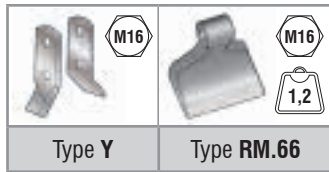
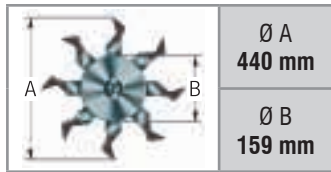

Sistema di taglio elicoidale
Helical cutting system
Spiralrotor
Sistema de corte helicoidal
Système de coupe hélicoïdal



Mod. TSP 2400 / 2600 / 2800 / 3000

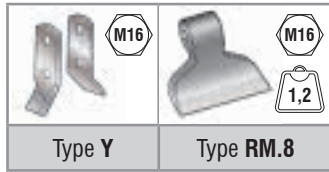
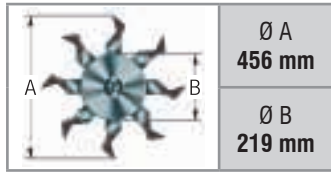

Sistema di taglio elicoidale
Helical cutting system
Spiralrotor
Sistema de corte helicoidal
Système de coupe hélicoïdal



MOD	MOVEMENT MACHINE					WORKING WIDTH	Standard		
	mod.	cm	cm	cm	cm		nr	nr (RM.66)	nr (RM.8)
TSP 1400	84	79	54	109	30	140	36	18	--
TSP 1600	88	94	48	134	40	160	40	20	--
TSP 1800	94	107	54	147	40	180	48	24	--
TSP 2000	110	110	70	150	40	200	48	24	--
TSP 2200	131	112	91	152	40	220	56	28	--
TSP 2400	130	130	90	170	40	240	64	--	32
TSP 2600	156	124	116	164	40	260	64	--	32
TSP 2800	155	145	115	185	40	280	72	--	36
TSP 3000	170	150	130	190	40	300	80	--	40

cod.	A richiesta	On request	Auf Anfrage	Opcionales	Sur demande
5130003	Cardano T-40	PTO shaft T-40	Gelenkwelle T-40	Cardán T-40	Cardan T-40
5130005	Cardano T-50	PTO shaft T-50	Gelenkwelle T-50	Cardán T-50	Cardan T-50
5130009	Cardano T-60	PTO shaft T-60	Gelenkwelle T-60	Cardán T-60	Cardan T-60
5130010	Cardano T-70	PTO shaft T-70	Gelenkwelle T-70	Cardán T-70	Cardan T-70
5227910	Lam. antiusura ant. TSP 1400	Front anti-wear plate TSP 1400	Verschleißplatte TSP 1400	Placa anti desgaste del. TSP 1400	Plaque avant anti-usure TSP 1400
5227911	Lam. antiusura ant. TSP 1600	Front anti-wear plate TSP 1600	Verschleißplatte TSP 1600	Placa anti desgaste del. TSP 1600	Plaque avant anti-usure TSP 1600
5227912	Lam. antiusura ant. TSP 1800	Front anti-wear plate TSP 1800	Verschleißplatte TSP 1800	Placa anti desgaste del. TSP 1800	Plaque avant anti-usure TSP 1800
5227913	Lam. antiusura ant. TSP 2000	Front anti-wear plate TSP 2000	Verschleißplatte TSP 2000	Placa anti desgaste del. TSP 2000	Plaque avant anti-usure TSP 2000
5227914	Lam. antiusura ant. TSP 2200	Front anti-wear plate TSP 2200	Verschleißplatte TSP 2200	Placa anti desgaste del. TSP 2200	Plaque avant anti-usure TSP 2200
5227915	Lam. antiusura ant. TSP 2400	Front anti-wear plate TSP 2400	Verschleißplatte TSP 2400	Placa anti desgaste del. TSP 2400	Plaque avant anti-usure TSP 2400
5227916	Lam. antiusura ant. TSP 2600	Front anti-wear plate TSP 2600	Verschleißplatte TSP 2600	Placa anti desgaste del. TSP 2600	Plaque avant anti-usure TSP 2600
5227917	Lam. antiusura ant. TSP 2800	Front anti-wear plate TSP 2800	Verschleißplatte TSP 2800	Placa anti desgaste del. TSP 2800	Plaque avant anti-usure TSP 2800
5227918	Lam. antiusura ant. TSP 3000	Front anti-wear plate TSP 3000	Verschleißplatte TSP 3000	Placa anti desgaste del. TSP 3000	Plaque avant anti-usure TSP 3000
2050010	Gruppo spost. idr. 30 cm	Hydraulic side shift 30 cm	Hydraulische Verschiebung 30 cm	Kit desplazador hidr. 30 cm	Groupe de dépl. lat. 30 cm
2050011	Gruppo spost. idr. 40 cm	Hydraulic side shift 40 cm	Hydraulische Verschiebung 40 cm	Kit desplazador hidr. 40 cm	Groupe de dépl. lat. 40 cm

cod.	Ricambi	Spare parts	Ersatzteile	Recambios	Pièces de rechange
5354071	Cinghia SPB-1525	Cug belt SPB-1525	Keilriemen SPB-1525	Correa SPB-1525	Courroie SPB-1525
5315446	Vite M16 per utensile	M16 screw for tool	M16 Schraube für Werkzeug	Tornillo M16 para herramienta	Vis M16 pour outil
5323017	Dado M16 per utensile	M16 nut for tool	M16 Mutter für Werkzeug	Tuerca M16 para herramienta	Ecrou M16 pour outil
5350121	Mazza RM.66	Hammer RM.66	Hammer RM.66	Martillo RM.66	Marteau RM.66
5350128	Mazza RM.8	Hammer RM.8	Hammer RM.8	Martillo RM.8	Marteau RM.8
5350127	Coltello "Y"	"Y" blade	"Y" Messer	Cuchilla "Y"	Couteau "Y"
2020025	Scatola trasm. 1400/1600/1800	Gear box TSP 1400/1600/1800	Getriebe TSP 1400/1600/1800	Caja de engran. 1400/1600/1800	Boîtier de transm. 1400/1600/1800
2020015	Scatola trasm. TSP 2000	Gear box TSP 2000	Getriebe TSP 2000	Caja de engran. TSP 2000	Boîtier de transm. TSP 2000
2020088	Scatola trasm. TSP 2200	Gear box TSP 2200	Getriebe TSP 2200	Caja de engran. TSP 2200	Boîtier de transm. TSP 2200
2020036	Scatola trasm. TSP 2400	Gear box TSP 2400	Getriebe TSP 2400	Caja de engran. TSP 2400	Boîtier de transm. TSP 2400
2020045	Scatola trasm. TSP 2600-2800	Gear box TSP 2600-2800	Getriebe TSP 2600-2800	Caja de engran. TSP 2600-2800	Boîtier de transm. TSP 2600-2800
2020043	Scatola trasm. TSP 3000	Gear box TSP 3000	Getriebe TSP 3000	Caja de engran. TSP 3000	Boîtier de transm. TSP 3000

Impiego	Use	Verwendung	Uso	Utilisation
---------	-----	------------	-----	-------------

La trinciaerba e sarmenti LFG si presta in modo ottimale per la triturazione di sarmenti, mais, erba, sterpaglie, paglia, e molto altro.

The LFG mulcher is ideal for mulching twigs, grass, brushwood, hay and more besides.

Das LFG Mulchgerät ist für den Heckanbau an Traktoren mit hoher Leistung (80 bis 150 HP) ausgelegt. Es eignet sich optimal zum Zerkleinern von Gras, Gehölzschnitt, Mais, Reisig, Ästen, Stroh und vielem mehr.

La trituradora de hierba y sarmentos LFG es excelente para triturar sarmentos, hierba, malezas, paja y mucho más.

Le broyeur d'herbe et de sarments LFG est particulièrement indiqué pour le broyage de sarments, herbe, broussailles, paille et de nombreux autres végétaux.

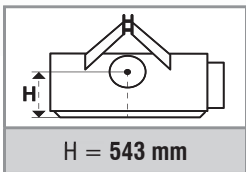
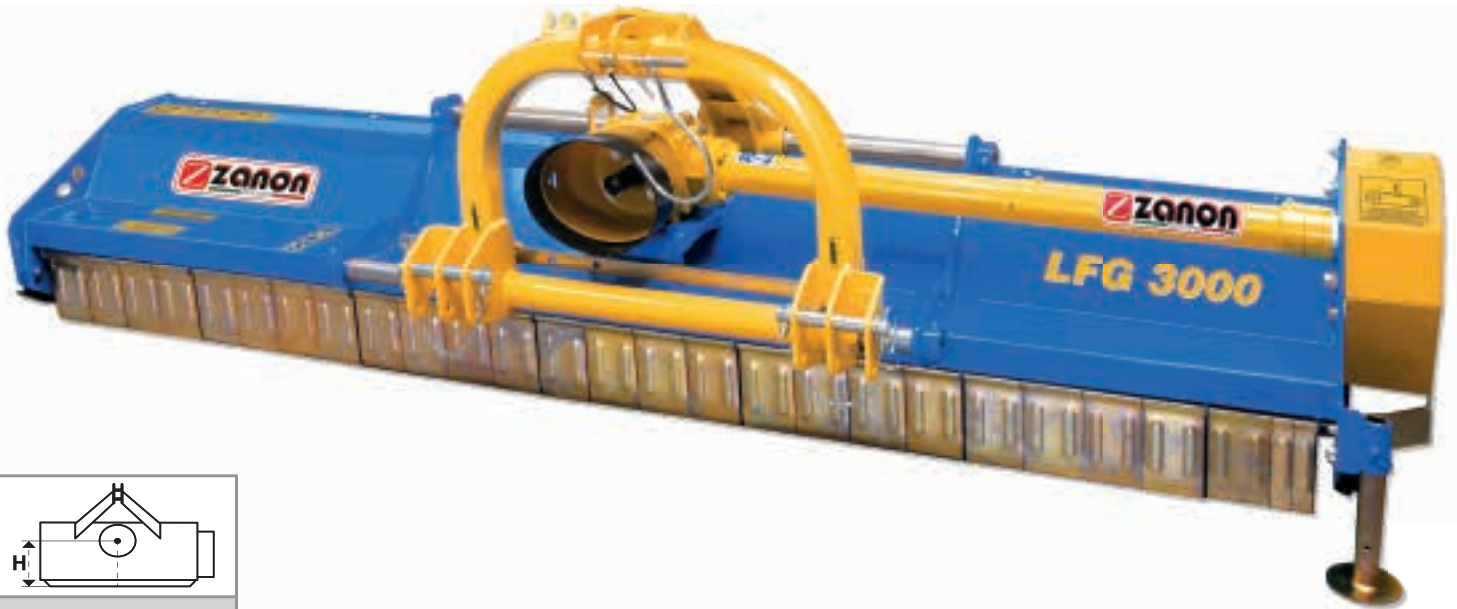

mod.	cod.	cod.	HP	rpm/min	type	nr (type)	cm	kg
LFG 2400	1002583	1002582	70 - 130	540/1000	T-60	5 (SPB 1525)	262×115×92	795
LFG 2600	1002585	1002584	70 - 130	540/1000	T-70	6 (SPB 1525)	280×115×92	825
LFG 2800	1002587	1002586	80 - 130	540/1000	T-70	6 (SPB 1525)	299×115×92	880
LFG 3000	1002589	1002588	100 - 150	540/1000	T-70	6 (SPB 1525)	319×115×92	915

Di serie	Standard equipment	Serienmässig	Estándar	De série
<ul style="list-style-type: none"> Scatola di trasmissione con ruota libera PTO 1 3/8" Z6 Rotore con sistema di taglio elicoidale Spostamento su barre cromate Spostamento laterale meccanico Doppia fila di pettini rompitori Slitte d'appoggio regolabili in altezza Rullo ozioso posteriore regolabile in altezza (194 mm) Raschiafango per pulizia rullo ozioso Scarico anteriore rullo ozioso Cofano apribile (solo per ispezione) Protezione anteriore a bandinelle Protezioni antinfortunistiche conformi alla normativa CE 	<ul style="list-style-type: none"> Gearbox with freewheel clutch PTO 1 3/8" Z6 Rotor with helical cutting system Side shift on chrome bars Mechanical side shift Double row counter-blades Height-adjustable skids Rear levelling roller height adjustable (194 mm) Scraper for rear levelling roller Discharge of the material over the levelling roller Opening hood (for inspection only) Front protection with metal flaps Protective equipment as per EC safety rules 	<ul style="list-style-type: none"> Getriebe mit integriertem Freilauf PTO 1 3/8" Z6 Spiralrotor Seitenverschiebung über Chromstangen Mechanische Seitenverschiebung 2 Reihen Gegenschneide Höhenverstellbare Stützkufen Hintere Stützwalze höhenverstellbar (194 mm) Walzenabstreifer Entladung des Materials über die Walze Heckhaube (darf nur für Wartungsarbeiten geöffnet werden) Frontschutz mit Metallklappen Unfallschutz nach EU-Vorschriften 	<ul style="list-style-type: none"> Caja de engranajes con rueda libre TDF 1 3/8" Z6 Rotor con sistema de corte helicoidal Desplazamiento sobre tubo cromado Desplazamiento lateral mecánico Doble fila de rompedores Patines de apoyo regulable en altura Rodillo nivelador trasero (194 mm), con regulación en altura Limpiador montado en el rodillo nivelador trasero Descarga anterior al rodillo nivelador Portón trasero aperturable (solo para inspección) Protección delantera mediante placas metálicas Protecciones de seguridad de acuerdo con la norma CE 	<ul style="list-style-type: none"> Boîtier de transmission avec roue libre PDF 1 3/8" Z6 Rotor avec système de coupe hélicoïdal Déplacement avec barre chromée Déport latéral mécanique Double rangée de peignes Patins d'appui réglables en hauteur Rouleau d'appui arrière réglable en hauteur (194 mm) Racleur pour le rouleau d'appui Ejection devant le rouleau d'appui Capot ouvrant (pour inspection seulement) Protection avant avec volets métalliques Protections contre les accidents aux normes CE

LFG	MULCHER MEDIUM DUTY
LFG	MULCHGERÄTE: MITTELSCHWERE AUSFÜHRUNG
LFG	TRITURADORA DE HIERBA Y SARMIENTOS
LFG	BROYEUR D'HERBE ET DE SARMENTS



ORIGINAL MADE IN ITALY

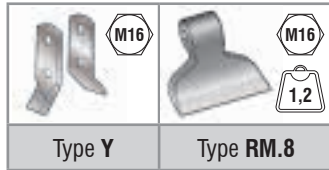
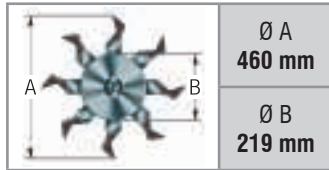

Sistema di taglio elicoidale
Helical cutting system
Spiral rotor
Sistema de corte helicoidal
Système de coupe hélicoïdal



MOD	MOVEMENT MACHINE					WORKING WIDTH	Standard		On request
	cm		cm		cm		nr	nr	
LFG 2400	131	131	91	171	40	240	64	32	20
LFG 2600	156	124	116	164	40	260	64	32	21
LFG 2800	156	143	116	183	40	280	72	36	22
LFG 3000	171	148	131	188	40	300	80	40	24

cod.	A richiesta	On request	Auf Anfrage	Opcionales	Sur demande
5130009	Cardano T-60	PTO shaft T-60	Gelenkwelle T-60	Cardán T-60	Cardan T-60
5130010	Cardano T-70	PTO shaft T-70	Gelenkwelle T-70	Cardán T-70	Cardan T-70
2050011	Gruppo spost. idr. 40 cm	Hydraulic side shift 40 cm	Hydraulische Verschiebung 40 cm	Kit desplazador hidr. 40 cm	Groupe de dépl. lat. 40 cm
5210292	Aste di raccolta sarmenti	Twig rakes	Holzaufnahmezinken	Astas de cosecha	Tiges de ramassage
2050005	Kit ruote posteriori in gomma sterzanti	Rear rubber steering wheels kit	Satz hintere Gummilenkräder	Kit de ruedas traseras, en goma, direccionales	Kit roues arrière directrices en caoutchouc
5227915	Lam. antiusura ant. LFG 2400	Front anti-wear plate LFG 2400	Verschleißplatte LFG 2400	Placa anti desgaste del.LFG 2400	Plaque avant anti-usure LFG 2400
5227916	Lam. antiusura ant. LFG 2600	Front anti-wear plate LFG 2600	Verschleißplatte LFG 2600	Placa anti desgaste del.LFG 2600	Plaque avant anti-usure LFG 2600
5227917	Lam. antiusura ant. LFG 2800	Front anti-wear plate LFG 2800	Verschleißplatte LFG 2800	Placa anti desgaste del.LFG 2800	Plaque avant anti-usure LFG 2800
5227918	Lam. antiusura ant. LFG 3000	Front anti-wear plate LFG 3000	Verschleißplatte LFG 3000	Placa anti desgaste del.LFG 3000	Plaque avant anti-usure LFG 3000
2050832	Kit ingombro macchina	Overall dimensions machine kit	Kit Warntafeln	Dispositivos dim. máx. de la máquina	Kit éclairage et signalisation

cod.	Ricambi	Spare parts	Ersatzteile	Recambios	Pièces de rechange
5354071	Cinghia SPB-1525	Cug belt SPB-1525	Keilriemen SPB-1525	Correa SPB-1525	Courroie SPB-1525
5315446	Vite M16 per utensile	M16 screw for tool	M16 Schraube für Werkzeug	Tornillo M16 para herramienta	Vis M16 pour outil
5323017	Dado M16 per utensile	M16 nut for tool	M16 Mutter für Werkzeug	Tuerca M16 para herramienta	Ecrou M16 pour outil
5350128	Mazza RM.8	Hammer RM.8	Hammer RM.8	Martillo RM.8	Marteau RM.8
5350127	Coltello "Y"	"Y" blade	"Y" Messer	Cuchilla "Y"	Couteau "Y"
2020036	Scatola trasmissione LFG 2400	Gear box LFG 2400	Getriebe LFG 2400	Caja de engranajes LFG 2400	Boîtier de transm. LFG 2400
2020045	Scatola trasmis. LFG 2600/2800	Gear box LFG 2600/2800	Getriebe LFG 2600/2800	Caja de engran. LFG 2600/2800	Boîtier de transm. LFG 2600/2800
2020043	Scatola trasmissione LFG 3000	Gear box LFG 3000	Getriebe LFG 3000	Caja de engranajes LFG 3000	Boîtier de transm. LFG 3000



cod. 2050005
On request
Kit ruote posteriori
Rear wheel kit
Satz hinterräder
Kit ruedas posteriores
Kit roues arriere



cod. 2050832
On request
Kit ingombro macchina
Overall dimensions machine kit
Kit Warntafeln
Kit éclairage et signalisation
Dispositivos dimensiones máx. de la máquina



Impiego

La trinciaerba e sarmenti TFB grazie all'altezza ridotta della scocca (50cm) si presta in modo ottimale alla pulizia dai residui di potatura e arbusti in genere in colture a fusto e fronde basse come frutteti, uliveti e vigneti. È ideale anche per la triturazione di sarmenti, mais, erba, sterpaglie, paglia, piantagioni in genere, e molto altro.

Use

Low body height (only 50cm) makes the TFB mulcher ideal for general purpose shrub and pruning waste mulching in low foliage stem crops, orchards, olive groves and vineyards. It is ideal for mulching grass, maize, hay, pruning waste (in olive groves, orchards, etc.), brushwood and more besides.

Verwendung

Dank der reduzierten Höhe des Rahmens (nur 50 cm) eignet sich das TFB Mulchgerät ideal für die Reinigung von Schnittresten und Sträuchern in Obst-, Oliven- und Weingärten.

Uso

La trituradora de hierba y sarmientos TFB gracias a la altura baja de su carcasa (50 cm) se presta muy bien para la limpieza de los restos de poda y arbustos en general en cultivos de árboles de follaje bajo como frutales, olivos y viñedos. Es excelente para la trituración de hierba, maíz, paja, residuos de poda (en olivares, frutales, etc.), malezas y mucho más.

Utilisation

Le broyeur d'herbe et de sarments TFB, grâce à la hauteur réduite de la coque (50 cm) est particulièrement indiqué pour le nettoyage des déchets d'élagage et d'arbustes en général dans les cultures avec tronc et frondaisons basses comme les vergers, les oliveraies et les vignes. Il est particulièrement indiqué pour le broyage d'herbe, maïs, paille, déchets d'élagage (dans les oliveraies, les vergers, etc.), de broussailles et autres végétaux.

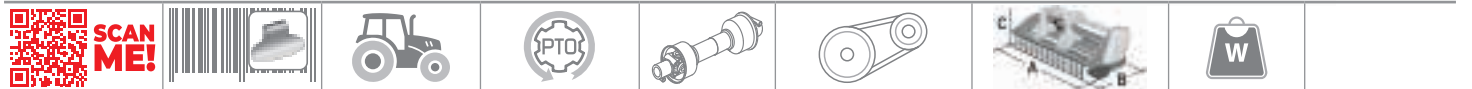
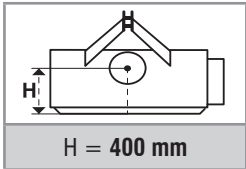

mod.	cod.	HP	rpm/min	type	nr (type)	cm	kg
TFB 1200	1002612	30 - 90	540/1000	T-40	2 (XPB 1340)	144×132×83	505
TFB 1400	1002613	40 - 90	540/1000	T-40	3 (XPB 1340)	163×132×83	550
TFB 1500	1002853	40 - 90	540/1000	T-40	3 (XPB 1340)	171×132×83	600
TFB 1600	1002614	50 - 90	540/1000	T-50	3 (XPB 1340)	183×132×83	610
TFB 1800	1002615	50 - 90	540/1000	T-50	4 (XPB 1340)	202×132×83	650
TFB 2000	1002616	50 - 90	540/1000	T-60	4 (XPB 1340)	220×132×83	705
TFB 2200	1002617	60 - 90	540/1000	T-60	5 (XPB 1340)	243×132×83	760
TFB 2400	1002618	60 - 130	540/1000	T-60	5 (XPB 1340)	262×132×83	805
TFB 2600	1002619	60 - 130	540/1000	T-70	6 (XPB 1340)	281×132×83	860
TFB 2800	1002620	80 - 130	540/1000	T-70	6 (XPB 1340)	300×132×83	905
TFB 3000	1002621	100 - 130	540/1000	T-70	6 (XPB 1340)	319×132×83	930

Di serie	Standard equipment	Serienmässig	Estándar	De série
<ul style="list-style-type: none"> Scatola di trasmissione con ruota libera PTO 1 3/8" Z6 Rotore con sistema di taglio elicoidale Spostamento su barre cromate Spostamento laterale meccanico Doppia fila di pettini rompitori Slitte d'appoggio regolabili in altezza Carter arrotondato Rullo ozioso posteriore regolabile in altezza (194 mm) Raschiafango per pulizia rullo ozioso Scarico anteriore rullo ozioso Cofano apribile (solo per ispezione) Telaio con doppia lamiera Protezione anteriore a bandinelle Protezioni antinfortunistiche conformi alla normativa CE 	<ul style="list-style-type: none"> Gearbox with freewheel clutch PTO 1 3/8" Z6 Rotor with helical cutting system Side shift on chrome bars Mechanical side shift Double row counter-blades Height-adjustable skids Rounded belt guard Rear levelling roller height adjustable (194 mm) Scraper for rear levelling roller Discharge of the material over the levelling roller Opening hood (for inspection only) Double skinned frame Front protection with metal flaps Protective equipment as per EC safety rules 	<ul style="list-style-type: none"> Getriebe mit integriertem Freilauf PTO 1 3/8" Z6 Spiralrotor Seitenverschiebung über Chromstangen Mechanische Seitenverschiebung 2 Reihen Gegenschneide Höhenverstellbare Stützkufen Abgerundeter Keilriemenschutz Hintere Stützwalze höhenverstellbar (194 mm) Walzenabstreifer Entladung des Materials über die Walze Heckhaube (darf nur für Wartungsarbeiten geöffnet werden) Doppelwandiger Rahmen Frontschutz mit Metallklappen Unfallschutz nach EU-Vorschriften 	<ul style="list-style-type: none"> Caja de engranajes con rueda libre TDF 1 3/8" Z6 Rotor con sistema de corte helicoidal Desplazamiento sobre tubo cromado Desplazamiento lateral mecánico Doble fila de rompedores Patines de apoyo regulable en altura Carter redondeado Rodillo nivelador trasero (194 mm), con regulación en altura Limpiaor montado en el rodillo nivelador trasero Descarga anterior al rodillo nivelador Portón trasero aperturable (solo para inspección) Interior del cuerpo de maquina, con doble chapa Protección delantera mediante placas metálicas Protecciones de seguridad de acuerdo con la norma CE 	<ul style="list-style-type: none"> Boîtier de transmission avec roue libre PDF 1 3/8" Z6 Rotor avec système de coupe hélicoïdale Déplacement avec barre chromée Déport latéral mécanique Double rangée de peignes Patins d'appui réglables en hauteur Carter arrondi Rouleau d'appui arrière réglable en hauteur (194 mm) Racleur pour le rouleau d'appui Ejection devant le rouleau d'appui Capot ouvrant (pour inspection seulement) Caisson renforcé par blindage interne Protection avant avec volets métalliques Protections contre les accidents aux normes CE

TFB	MULCHER MEDIUM DUTY
TFB	MULCHGERÄTE: MITTELSCHWERE AUSFÜHRUNG
TFB	TRITURADORA DE HIERBA Y SARMIENTOS
TFB	BROYEUR D'HERBE ET DE SARMENTS



ORIGINAL MADE IN ITALY

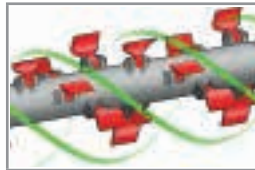
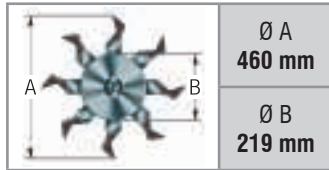

Sistema di taglio elicoidale
Helical cutting system
Spiralrotor
Sistema de corte helicoidal
Système de coupe hélicoïdal



MOD	MOVEMENT MACHINE			
mod.	cm	cm	cm	cm
TFB 1200	76	68	46	98
TFB 1400	76	87	46	117
TFB 1500	95	76	55	116
TFB 1600	95	88	55	128
TFB 1800	95	107	55	147
TFB 2000	111	109	71	149
TFB 2200	132	111	92	151
TFB 2400	132	130	92	170
TFB 2600	157	124	117	164
TFB 2800	157	143	117	183
TFB 3000	172	147	132	187

WORKING WIDTH	Standard	On request
cm	nr	nr
120	10	10
140	12	12
150	12	13
160	14	14
180	16	16
200	18	18
220	20	19
240	20	20
260	22	21
280	24	22
300	26	24

cod.	A richiesta	On request	Auf Anfrage	Opcionales	Sur demande
5130003	Cardano T-40	PTO shaft T-40	Gelenkwelle T-40	Cardán T-40	Cardan T-40
5130005	Cardano T-50	PTO shaft T-50	Gelenkwelle T-50	Cardán T-50	Cardan T-50
5130009	Cardano T-60	PTO shaft T-60	Gelenkwelle T-60	Cardán T-60	Cardan T-60
5130010	Cardano T-70	PTO shaft T-70	Gelenkwelle T-70	Cardán T-70	Cardan T-70
2050010	Gruppo spost. idr. 30 cm	Hydraulic side shift 30 cm	Hydraulische Verschiebung 30 cm	Kit desplazador hidr. 30 cm	Groupe de dépl. lat. 30 cm
2050011	Gruppo spost. idr. 40 cm	Hydraulic side shift 40 cm	Hydraulische Verschiebung 40 cm	Kit desplazador hidr. 40 cm	Groupe de dépl. lat. 40 cm
5210292	Aste di raccolta sarmenti	Twig rakes	Holzaufnahmezinken	Astas de cosecha	Tiges de ramassage
2050005	Kit ruote posteriori in gomma sterzanti	Rear rubber steering wheels kit	Satz hintere Gummilenkräder	Kit de ruedas traseras, en goma, direccionales	Kit roues arrière directrices en caoutchouc

cod.	Ricambi	Spare parts	Ersatzteile	Recambios	Pièces de rechange
5354049	Cinghia XPB-1340	Cug Belt XPB-1340	Keilriemen XPB-1340	Correa XPB-1340	Courroie XPB-1340
5315093	Vite M20 per utensile	M20 screw for tool	M20 Schraube für Werkzeug	Tornillo M20 para herramienta	Vis M20 pour outil
5323018	Dado M20 per utensile	M20 nut for tool	M20 Mutter für Werkzeug	Tuerca M20 para herramienta	Ecrou M20 pour outil
5350110	Mazza RM.11	Hammer RM.11	Hammer RM.11	Martillo RM.11	Marteau RM.11
2020024	Scat. trasm. TFB 1200/1400	Gear box TFB 1200/1400	Getriebe TFB 1200/1400	Caja de engran. TFB 1200/1400	Boîtier de transm.TFB 1200/1400
2020025	Scat. trasm. TFB 1500/1600/1800	Gear box TFB 1500/1600/1800	Getriebe TFB 1500/1600/1800	Caja de engran. TFB 1500/1600/1800	Boîtier de transm.TFB 1500/1600/1800
2020015	Scat. trasm. TFB 2000	Gear box TFB 2000	Getriebe TFB 2000	Caja de engran. TFB 2000	Boîtier de transm.TFB 2000
2020088	Scat. trasm. TFB 2200	Gear box TFB 2200	Getriebe TFB 2200	Caja de engran. TFB 2200	Boîtier de transm.TFB 2200
2020036	Scat. trasm. TFB 2400	Gear box TFB 2400	Getriebe TFB 2400	Caja de engran. TFB 2400	Boîtier de transm.TFB 2400
2020045	Scat. trasm. TFB 2600/2800	Gear box TFB 2600/2800	Getriebe TFB 2600/2800	Caja de engran. TFB 2600/2800	Boîtier de transm.TFB 2600/2800
2020043	Scat. trasm. TFB 3000	Gear box TFB 3000	Getriebe TFB 3000	Caja de engran. TFB 3000	Boîtier de transm.TFB 3000

cod. 2050005
On request

Kit ruote posteriori
Rear wheel kit
Satz hinterräder
Kit ruedas posteriores
Kit roues arriere



Impiego

La trinciaerba e sarmenti pesante TMU si presta in modo ottimale per la triturazione di sarmenti, mais, erba, paglia, tabacco, carciofi, bietole, cotone, e molto altro.

Use

The TMU heavy duty mulcher is ideal for mulching twigs, maize, grass, hay, tobacco, artichokes, beet, cotton, and more besides.

Verwendung

Das TMU Mulchgerät ist ein schweres Modell und eignet sich ideal zum Zerkleinern von Gras, Gehölzschnitt und Ästen mit großem Durchmesser. Ideal zum Reinigen von nicht kultivierten Flächen oder Gestrüpp.

Uso

La trituradora de hierba y sarmientos TMU es excelente para triturar sarmientos, maíz, hierba, paja, tabaco, alcachofas, remolachas, algodón y mucho más.

Utilisation

Le broyeur d'herbe et de sarments lourd TMU est particulièrement indiqué pour le broyage de sarments, maïs, herbe, paille, tabac, artichauts, bettes, coton, et de nombreux autres végétaux.

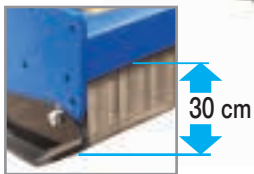
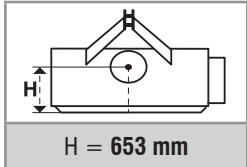

mod.	cod.	cod.	HP	rpm/min	type	nr (type)	cm	kg
TMU 1650	1002356	1002357	50 - 90	540/1000	T-50	5 (SPB 1465)	190×95×100	665
TMU 1850	1002358	1002359	60 - 90	540/1000	T-60	5 (SPB 1465)	212×95×100	695
TMU 2100	1002360	1002361	70 - 130	540/1000	T-60	6 (SPB 1465)	233×95×100	760
TMU 2300	1002362	1002363	80 - 130	540/1000	T-70	6 (SPB 1465)	255×95×100	820
TMU 2500	1002980	1002979	80 - 130	540/1000	T-70	6 (SPB 1465)	285×95×100	900

Di serie	Standard equipment	Serienmässig	Estándar	De série
<ul style="list-style-type: none"> Scatola di trasmissione con ruota libera PTO 1 3/8" Z6 Rotore con sistema di taglio lineare Spostamento su barre cromate Spostamento laterale meccanico Doppia fila di pettini rompitori Slitte d'appoggio regolabili in altezza Rullo ozioso posteriore regolabile in altezza (194 mm) Aste di raccolta sarmenti Raschiafango per pulizia rullo ozioso Scarico anteriore rullo ozioso Cofano apribile (solo per ispezione) Telaio con doppia lamiera Protezione anteriore a bandinelle Protezioni antinfortunistiche conformi alla normativa CE 	<ul style="list-style-type: none"> Gearbox with freewheel clutch PTO 1 3/8" Z6 Rotor with linear cutting system Side shift on chrome bars Mechanical side shift Double row counter-blades Height-adjustable skids Rear levelling roller height adjustable (194 mm) Twig rakes Scraper for rear levelling roller Discharge of the material over the levelling roller Opening hood (for inspection only) Double skinned frame Front protection with metal flaps Protective equipment as per EC safety rules 	<ul style="list-style-type: none"> Getriebe mit integriertem Freilauf PTO 1 3/8" Z6 Rotor mit linear Schnitssystem Seitenverschiebung über Chromstangen Mechanische Seitenverschiebung 2 Reihen Gegenschneide Höhenverstellbare Stützkufen Hinterer Stützwalze höhenverstellbar (194 mm) Holzaufnahmezinken Walzenabstreifer Entladung des Materials über die Walze Heckhaube (darf nur für Wartungsarbeiten geöffnet werden) Doppelwandiger Rahmen Frontschutz mit Metallklappen Unfallschutz nach EU-Vorschriften 	<ul style="list-style-type: none"> Caja de engranajes con rueda libre TDF 1 3/8" Z6 Rotor con sistema de corte lineal Desplazamiento sobre tubo cromado Desplazamiento lateral mecánico Doble fila de rompedores Patines de apoyo reg. en altura Rodillo nivelador trasero (194 mm), con regulación en altura Astas de cosecha Limpiador montado en el rodillo nivelador trasero Descarga anterior al rodillo nivelador Portón trasero aperturable (solo para inspección) Interior del cuerpo de maquina, con doble chapa Protección delantera mediante placas metálicas Protecciones de seguridad de acuerdo con la norma CE 	<ul style="list-style-type: none"> Boîtier de transmission avec roue libre PDF 1 3/8" Z6 Rotor avec système de coupe linéaire Déplacement avec barre chromée Déport latéral mécanique Double rangée de peignes Patins d'appui réglables en hauteur Rouleau d'appui arrière réglable en hauteur (194 mm) Tiges de ramassage Racleur pour le rouleau d'appui Ejection devant le rouleau d'appui Capot ouvrant (pour inspection seulement) Caisson renforcé par blindage interne Protection avant avec volets métalliques Protections contre les accidents aux normes CE

TMU	MULCHER HEAVY DUTY
TMU	MULCHGERÄTE: SCHWERE AUSFÜHRUNG
TMU	TRITURADORA DE HIERBA Y SARMIENTOS
TMU	BROYEUR D'HERBE ET DE SARMENTS LOURD



ORIGINAL MADE IN ITALY

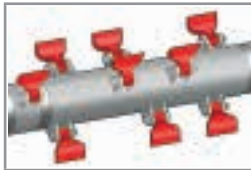
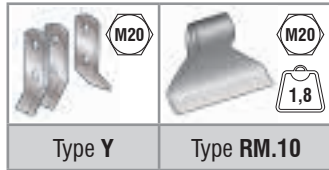
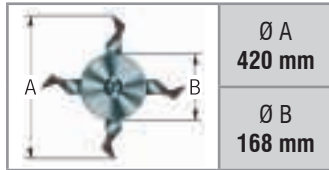

Sistema di taglio lineare
Linear cutting system
Linearrotor
Sistema de corte lineal
Système de coupe linéaire



MOD	MOVEMENT MACHINE					WORKING WIDTH	Standard			On request
	cm		cm		cm		nr	nr	nr	nr
TMU 1650	93	97	63	127	30	165	42	14	14	2 + 2
TMU 1850	113	99	63	149	40	185	48	16	16	2 + 2
TMU 2100	113	120	63	170	40	210	54	18	18	3 + 3
TMU 2300	133	122	83	170	40	230	60	20	20	3 + 3
TMU 2500	162	123	123	162	40	250	66	22	23	3 + 3

cod.	A richiesta	On request	Auf Anfrage	Opcionales	Sur demande
5130005	Cardano T-50	PTO shaft T-50	Gelenkwelle T-50	Cardán T-50	Cardan T-50
5130009	Cardano T-60	PTO shaft T-60	Gelenkwelle T-60	Cardán T-60	Cardan T-60
5130010	Cardano T-70	PTO shaft T-70	Gelenkwelle T-70	Cardán T-70	Cardan T-70
2050010	Gruppo spost. idr. 30 cm	Hydraulic side shift 30 cm	Hydraulische Verschiebung 30 cm	Kit desplazador hidr. 30 cm	Groupe de dépl. lat. 30 cm
2050011	Gruppo spost. idr. 40 cm	Hydraulic side shift 40 cm	Hydraulische Verschiebung 40 cm	Kit desplazador hidr. 40 cm	Groupe de dépl. lat. 40 cm
2050224	Kit ruote posteriori in gomma sterzanti	Rear rubber steering wheels kit	Satz hintere Gummilenkräder	Kit de ruedas traseras, en goma, direccionales	Kit roues arrière directrices en caoutchouc
5225854	Aletta spargitrice dx	Spreading wing rh	Verteilerfluegel Rechts	Aleta esparciadora izq.	Ailette de dispersion droite
5225855	Aletta spargitrice sx	Spreading wing lf	Verteilerfluegel Links	Aleta esparciadora dcha	Ailette de dispersion gauche

cod.	Ricambi	Spare parts	Ersatzteile	Recambios	Pièces de rechange
5354048	Cinghia XPB-1465	Cug belt XPB-1465	Keilriemen XPB-1465	Correa XPB-1465	Courroie XPB-1465
5315093	Vite M20 per utensile	M20 screw for tool	M20 Schraube für Werkzeug	Tornillo M20 para herramienta	Vis M20 pour outil
5323018	Dado M20 per utensile	M20 nut for tool	M20 Mutter für Werkzeug	Tuerca M20 para herramienta	Ecrou M20 pour outil
5350038	Mazza RM.10	Hammer RM.10	Hammer RM.10	Martillo RM.10	Marteau RM.10
5350040	Coltello "Y"	"Y" blade	"Y" Messer	Cuchilla "Y"	Couteau "Y"
2020034	Sc. trasm. TMU 1650/1850	Gear box TMU 1650/1850	Getriebe TMU 1650/1850	Caja de engr. TMU 1650/1850	Boîtier de transm. TMU 1650/1850
2020035	Scatola trasm. TMU 2100	Gear box TMU 2100	Getriebe TMU 2100	Caja de engranajes TMU 2100	Boîtier de transm. TMU 2100
2020036	Scatola trasm. TMU 2300	Gear box TMU 2300	Getriebe TMU 2300	Caja de engranajes TMU 2300	Boîtier de transm. TMU 2300
2020045	Scatola trasm. TMU 2500	Gear box TMU 2500	Getriebe TMU 2500	Caja de engranajes TMU 2500	Boîtier de transm. TMU 2500

cod. 2050224

On request

Kit ruote posteriori
Rear wheel kit
Satz hinterräder
Kit ruedas posteriores
Kit roues arriere



Impiego

La trinciaerba e sarmenti extra pesante TMS è una macchina studiata per essere applicata a trattori di medio-alta potenza (60-150 HP). Si presta in modo ottimale per la triturazione di sarmenti, mais, erba, paglia, tabacco, carciofi, bietole, cotone, e molto altro.

Use

The TMS mulcher extra heavy duty is designed for mounting on medium-high power tractors (60 to 150 HP). It is ideal for mulching twigs, maize, grass, hay, tobacco, artichokes, beet, cotton, and more besides.

Verwendung

Das TMS Mulchgerät ist für den Heckanbau an Traktoren mit mittlerer bis hoher Leistung (60 bis 150 HP) ausgelegt. Es eignet sich ideal zum Mulchen von Schnittresten, Sträuchern Heu, Maisstoppeln und Gartenabfällen.

Uso

La trituradora de hierba y sarmientos extra pesada TMS es una máquina diseñada para su aplicación en tractores de media alta potencia (60-150 HP). Es excelente para triturar sarmientos, maíz, hierba, paja, tabaco, alcachofas, remolachas, algodón y mucho más.

Utilisation

Le broyeur d'herbe et de sarments TMS est une machine conçue pour être appliquée sur des tracteurs de puissance moyenne-haute (60-150 HP). Il est particulièrement indiqué pour le broyage de sarments, maïs, herbe, paille, tabac, artichauts, bettes, coton, et de nombreux autres végétaux.

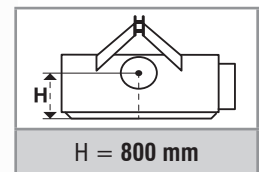
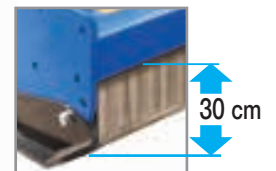

mod.	cod	HP	rpm/min	type	nr (type)	cm	kg
TMS 1400	1002520	60 - 110	540/1000	T-60	4 (XPB 1690)	165×120×115	785
TMS 2050	1002383	70 - 130	540/1000	T-60	5 (XPB 1690)	225×120×115	975
TMS 2600	1002838	90 - 150	540/1000	T-70	6 (XPB 1690)	280×120×115	1110

Di serie	Standard equipment	Serienmässig	Estándar	De série
<ul style="list-style-type: none"> Scatola di trasmissione con ruota libera PTO 1 3/8" Z6 Rotore con sistema di taglio lineare Spostamento su barre cromate Spostamento laterale meccanico Tripla fila di pettini rompitori Aste di raccolta sarmenti Slitte d'appoggio regolabili in altezza Rullo ozioso posteriore regolabile in altezza (194 mm) Raschiafango per pulizia rullo ozioso Scarico anteriore rullo ozioso Telaio con doppia lamiera Protezione anteriore a bandinelle e catene Protezioni antinfortunistiche conformi alla normativa CE 	<ul style="list-style-type: none"> Gearbox with freewheel clutch PTO 1 3/8" Z6 Rotor with linear cutting system Side shift on chrome bars Mechanical side shift Triple row counter-blades Twig rakes Height-adjustable skids Rear levelling roller height adjustable (194 mm) Scraper for rear levelling roller Discharge of the material over the levelling roller Double skinned frame Front protection with metal flaps and chains Protective equipment as per EC safety rules 	<ul style="list-style-type: none"> Getriebe mit integriertem Freilauf PTO 1 3/8" Z6 Rotor mit linear Schnittsystem Seitenverschiebung über Chromstangen Mechanische Seitenverschiebung 3 Reihen Gegenschneide Holzaufnahmezinken Höhenverstellbare Stützkufen Hintere Stützwalze höhenverstellbar (194 mm) Walzenabstreifer Entladung des Materials über die Walze Doppelwandiger Rahmen Frontschutz mit Metallklappen und Ketten Unfallschutz nach EU-Vorschriften 	<ul style="list-style-type: none"> Caja de engranajes con rueda libre TDF 1 3/8" Z6 Rotor con sistema de corte lineal Desplazamiento sobre tubo cromado Desplazamiento lateral mecánico Triple fila de rompedores Astas de cosecha Patines de apoyo regulable en altura Rodillo nivelador trasero (194 mm), con regulación en altura Limpiador montado en el rodillo nivelador trasero Descarga anterior al rodillo nivelador Interior del cuerpo de maquina, con doble chapa Protección delantera a placas metálicas y cadenas Protecciones de seguridad de acuerdo con la norma CE 	<ul style="list-style-type: none"> Boîtier de transmission avec roue libre PDF 1 3/8" Z6 Rotor avec système de coupe linéaire Déplacement avec barre chromée Déport latéral mécanique Triple rangée de peignes Tiges de ramassage Patins d'appui réglables en hauteur Rouleau d'appui arrière réglable en hauteur (194 mm) Racleur pour le rouleau d'appui Ejection devant le rouleau d'appui Caisson renforcé par blindage interne Protection avant avec volets métalliques et chaînes Protections contre les accidents aux normes CE

TMS	MULCHER EXTRA HEAVY DUTY
TMS	MULCHGERÄTE: EXTRASCHWERE AUSFÜHRUNG
TMS	TRITURADORA DE HIERBA Y SARMIENTOS EXTRA PESADA
TMS	BROYEUR D'HERBE ET DE SARMENTS

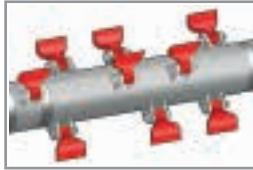
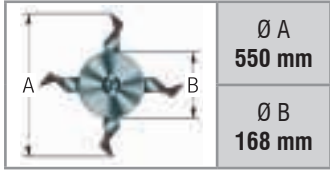

Sistema di taglio lineare
Linear cutting system
Linearrotor
Sistema de corte lineal
Système de coupe linéaire



MOD	MOVEMENT MACHINE				cm
	cm		cm		
TMS 1400	91	74	61	104	30
TMS 2050	11	114	71	154	40
TMS 2600	155	125	115	165	40

WORKING WIDTH	Standard	
	cm	nr
140	10	12
205	16	17
260	22	22

cod.	A richiesta	On request	Auf Anfrage	Opcionales	Sur demande
5130009	Cardano T-60	PTO shaft T-60	Gelenkwelle T-60	Cardán T-60	Cardan T-60
5130010	Cardano T-70	PTO shaft T-70	Gelenkwelle T-70	Cardán T-70	Cardan T-70
2050010	Gruppo spost. idr. 30 cm	Hydraulic side shift 30 cm	Hydraulische Verschiebung 30 cm	Kit desplazador hidr. 30 cm	Groupe de dépl. lat. 30 cm
2050011	Gruppo spost. idr. 40 cm	Hydraulic side shift 40 cm	Hydraulische Verschiebung 40 cm	Kit desplazador hidr. 40 cm	Groupe de dépl. lat. 40 cm
2050093	Kit ruote anteriori e posteriori in acciaio pivotanti	Pivoting steel front and rear wheels kit	Satz schwenkbare Stahl Front und Hinterräder	Kit de ruedas anteriores y traseras, en hierro, giratorias	Kit roues antérieures et arrière pivotantes en acier

cod.	Ricambi	Spare parts	Ersatzteile	Recambios	Pièces de rechange
5354058	Cinghia XPB-1690	Cug belt XPB-1690	Keilriemen XPB-1690	Correa XPB-1690	Courroie XPB-1690
5315550	Vite M20 per utensile	M20 screw for tool	M20 Schraube für Werkzeug	Tornillo M20 para herramienta	Vis M20 pour outil
5323018	Dado M20 per utensile	M20 nut for tool	M20 Mutter für Werkzeug	Tuerca M20 para herramienta	Ecrou M20 pour outil
5350098	Mazza RM.69	Hammer RM.69	Hammer RM.69	Martillo RM.69	Marteau RM.69
2020040	Sc. trasm. TMS 1400	Gear box TMS 1400	Getriebe TMS 1400	Caja de engr. TMS 1400	Boîtier de transm. TMS 1400
2020035	Sc. trasm. TMS 2050	Gear box TMS 2050	Getriebe TMS 2050	Caja de engr. TMS 2050	Boîtier de transm. TMS 2050
2020045	Sc. trasm. TMS 2600	Gear box TMS 2600	Getriebe TMS 2600	Caja de engr. TMS 2600	Boîtier de transm. 2600



cod. 2050093
On request
Kit ruote posteriori
Rear wheel kit
Satz hinterräder
Kit ruedas posteriores
Kit roues arriere



Impiego

La trinciaerba TMS-PRO è una macchina studiata per essere applicata a trattori di medio-alta potenza. Si presta in modo ottimale per la triturazione di residui di potatura e può essere utilizzata su qualsiasi terreno, anche di tipo sassoso.

Use

The TMS-PRO mulcher is designed for medium to high power tractors. It is ideal for shredding pruning waste and can be used over all kinds of terrain, including stony ground.

Verwendung

Das neue TMS-PRO Mulchgerät ist für Traktoren mit mittlerer und hoher Leistungstärke ausgelegt. Der TMS-PRO Mulchgerät eignet sich ideal für die Zerkleinerung von Schnittresten und kann auf jedem, auch steinigem, Gelände eingesetzt werden.

Uso

La trituradora TMS-PRO es una máquina diseñada para ser aplicada en tractores de potencia medio alta. Es excelente para triturar de manera ideal los residuos de poda y se puede utilizar en cualquier tipo de terreno, inclusive pedregoso.

Utilisation

Le broyeur d'herbe TMS-PRO est conçu pour être monté sur des tracteurs de moyenne-haute puissance. Il est idéal en particulier pour le broyage de résidus d'élagage et peut être utilisé sur n'importe quel terrain, y compris de type caillouteux.

NEW

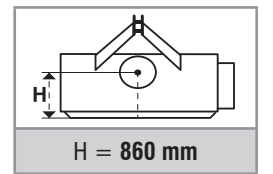
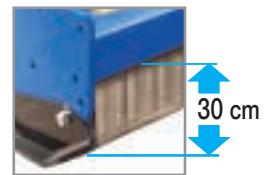

mod.	cod.	HP	rpm/min	type	nr (type)	cm	kg
TMS-PRO 1550	1003245	50 - 150	540/1000	T-60	4 (XPB 1800)	180×130×120	880
TMS-PRO 1850	1003246	60 - 150	540/1000	T-60	5 (XPB 1800)	205×130×120	1020
TMS-PRO 2050	1003247	70 - 150	540/1000	T-60	5 (XPB 1800)	225×130×120	1130
TMS-PRO 2300	1003248	80 - 150	540/1000	T-70	6 (XPB 1800)	250×130×120	1210
TMS-PRO 2600	1003249	90 - 150	540/1000	T-70	6 (XPB 1800)	280×130×120	1350

Nota: specificare se PTO 540 giri/min o PTO 1000 giri/min

Note: Specify PTO speed: 540 rpm or 1000 rpm.

Anmerkung: Bitte angeben, ob die Zapfwelle mit Drehzahl 540 U/min oder 1000 U/min gewünscht ist.

Nota: especificar si la toma de fuerza es de 540 r.p.m. o de 1000 r.p.m.

Note: préciser l'option PDF à 540 tours/min ou à 1000 tours/min.

Di serie	Standard equipment	Serienmässig	Estándar	De série
<ul style="list-style-type: none"> Scatola di trasmissione super rinforzata con ruota libera PTO 1 3/8" Z6 Rotore con sistema di taglio lineare Spostamento su barre cromate Spostamento laterale meccanico 4 file di pettini rompitori Aste di raccolta sarmenti Slitte d'appoggio in HARDOX regolabili in altezza Rullo ozioso posteriore regolabile in altezza (194 mm) Raschiafango per pulizia rullo ozioso Scarico anteriore rullo ozioso Telaio con doppia lamiera Protezione anteriore a bandinelle e catene Protezioni antinfortunistiche conformi alla normativa CE 	<ul style="list-style-type: none"> Super reinforced gearbox with freewheel clutch PTO 1 3/8" Z6 Rotor with linear cutting system Side shift on chrome bars Mechanical side shift 4 row counter-blades Self levelling blade Height-adjustable HARDOX skids Rear levelling roller height adjustable (194 mm) Scraper for rear levelling roller Discharge of the material over the levelling roller Double skinned frame Front protection with metal flaps and chains Protective equipment as per EC safety rules 	<ul style="list-style-type: none"> Superverstärkter Getriebe mit Freilauf PTO 1 3/8" Z6 Rotor mit linear Schnittsystem Seitenverschiebung über Chromstangen Mechanische Seitenverschiebung 4 Reihen Gegenschneide Holzreuchen Höhenverstellbare HARDOX-Stützkufen Hintere Stützwalze höhenverstellbar (194 mm) Walzenabstreifer Entladung des Materials über die Walze Doppelwandiger Rahmen Frontschutz mit Metallklappen und Ketten Unfallschutz nach EU-Vorschriften 	<ul style="list-style-type: none"> Caja de engranajes súper reforzada con rueda libre PDF 1 3/8" Z6 Rotor con sistema de corte lineal Desplazamiento sobre tubo cromado Desplazamiento lateral mecánico 4 fila de rompedores Rastrillo recoge sarmentos Patines de apoyo HARDOX regulable en altura Rodillo nivelador trasero (194 mm), con regulación en altura Limpiador montado en el rodillo nivelador trasero Descarga anterior al rodillo nivelador Interior del cuerpo de máquina, con doble chapa Protección delantera a placas metálicas y cadenas Protecciones de seguridad de acuerdo con la norma CE 	<ul style="list-style-type: none"> Boîtier de transmission super renforcée avec roue libre PDF 1 3/8" Z6 Rotor avec système de coupe linéaire Déplacement avec barre chromée Déport latéral mécanique 4 rangée de peignes Tige de ramassage Patins d'appui HARDOX réglables en hauteur Rouleau d'appui arrière réglable en hauteur (194 mm) Racleur pour le rouleau d'appui Ejection devant le rouleau d'appui Caisson renforcé par blindage interne Protection avant avec volets métalliques et chaînes Protections contre les accidents aux normes CE

TMS-PRO	MULCHER EXTRA HEAVY DUTY
TMS-PRO	MULCHGERÄTE EXTRASCHWERE AUSFÜHRUNG
TMS-PRO	TRITURADORA DE HIERBA Y SARMIENTOS EXTRA PESADA
TMS-PRO	BROYEUR D'HERBE ET DE SARMENTS LOURD

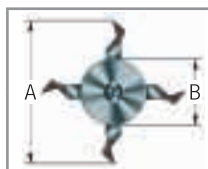

Ø A
550 mm

Ø B
168 mm

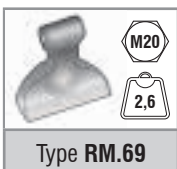

Sistema di taglio lineare
Linear cutting system
Linearrotor
Sistema de corte lineal
Système de coupe linéaire



MOD	MOVEMENT MACHINE					WORKING WIDTH	Standard	
mod.	cm	cm	cm	cm	cm	cm	nr	nr
TMS-PRO 1550	105	75	75	105	30	155	12	13
TMS-PRO 1850	107	98	77	128	30	185	14	15
TMS-PRO 2050	134	91	94	131	40	205	16	17
TMS-PRO 2300	135	115	95	75	40	230	18	19
TMS-PRO 2600	151	119	121	79	40	260	22	24

cod.	A richiesta	On request	Auf Anfrage	Opcionales	Sur demande
5130009	Cardano T-60	PTO shaft T-60	Gelenkwelle T-60	Cardán T-60	Cardan T-60
5130010	Cardano T-70	PTO shaft T-70	Gelenkwelle T-70	Cardán T-70	Cardan T-70
2050093	Kit ruote in acciaio pivotanti	Pivoting steel wheels kit	Satz schwenkbare Stahlräder	Kit de ruedas en hierro, giratorias	Kit roues pivotantes en acier
2050010	Gruppo spost. idr. 30 cm	Hydraulic side shift 30 cm	Hydraulische Verschiebung 30 cm	Kit desplazador hidr. 30 cm	Groupe de dépl. lat. 30 cm
2050011	Gruppo spost. idr. 40 cm	Hydraulic side shift 40 cm	Hydraulische Verschiebung 40 cm	Kit desplazador hidr. 40 cm	Groupe de dépl. lat. 40 cm

cod.	Ricambi	Spare parts	Ersatzteile	Recambios	Pièces de rechange
5354045	Cinghia XPB-1800	Cug belt XPB-1800	Keilriemen XPB-1800	Correa XPB-1800	Courroie XPB-1800
5315550	Vite M20 per utensile	M20 screw for tool	M20 Schraube für Werkzeug	Tornillo M20 para herramienta	Vis M20 pour outil
5323018	Dado M20 per utensile	M20 nut for tool	M20 Mutter für Werkzeug	Tuerca M20 para herramienta	Ecrou M20 pour outil
5350098	Mazza RM.69	Hammer RM.69	Hammer RM.69	Martillo RM.69	Marteau RM.69
2020158	Sc. trasm. TMS-PRO 1550/1850	Gear box TMS-PRO 1550/1850	Getriebe TMS-PRO 1550/1850	Caja de engran. 1550/1850	Boîtier de transm. 1550/1850
2020107	Sc. trasm. TMS-PRO 2050/2300	Gear box TMS-PRO 2050/2300	Getriebe TMS-PRO 2050/2300	Caja de engran. 2050/2300	Boîtier de transm. 2050/2300
2020190	Sc. trasm. TMS-PRO 2600	Gear box TMS-PRO 2600	Getriebe TMS-PRO 2600	Caja de engran. 2600	Boîtier de transm. 2600



Impiego Use Verwendung Uso Utilisation

La trinciastocchi TSF è una macchina studiata per essere applicata a trattori di medio-alta potenza (70-150 HP). Si presta in modo ottimale per la triturazione di paglia stocchi di mais e tralci in coltivazioni ortofrutti-cole nei vigneti e nei vivai.

The TSF mulcher is designed for mounting on medium to high power tractors (70 to 150 HP). It is ideal for mulching hay, maize stalks and horticultural crop waste in vineyards and plant nurseries.

Das TSF Mulchgerät ist für den Heckanbau an Traktoren mit mittlerer bis hoher Leistung (70 bis 150 HP) ausgelegt. Es eignet sich ideal zum Mulchen von Heu, Maisstop-peln und Gartenbauabfällen.

La trituradora TSF es una máquina diseñada para su aplicación en tractores de medio alta potencia (70-150 HP). La trituradora TSF es excelente para triturar paja, tallos de maíz y ramas herbáceas en cultivos orto-frutícolas, viñedos y viveros.

Le broyeur TSF est une machine conçue pour être appliquée sur des tracteurs de puissance moyenne-haute (70-150 HP). Le broyeur TSF est particulièrement indiqué pour le broyage de chaumes, de tiges de maïs et de sarments dans les cultures maraîchères, les vignes et les pépinières.

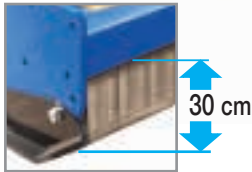
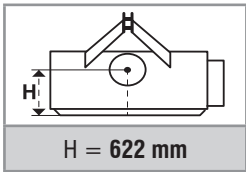

mod.	cod.	cod.	HP	rpm/min	type	nr (type)	cm	kg
TSF 2000	1002628	1002629	70 - 150	540	T-60	5 (XPB 1800)	222×147×104	865
TSF 2300	1002364	1002365	80 - 150	540	T-60	5 (XPB 1800)	259×147×104	945
TSF 2700	1002366	--	80 - 150	1000	T-70	6 (XPB 1800)	294×147×104	1055
TSF 3100 *	1002368	1002369	110 - 150	1000	T-70	6 (XPB 1800)	330×147×104	1190

Supplemento per ruote posteriori • Surcharge for rear wheels • Aufpreis für Hinterräder • Recargo de ruedas posteriores • Supplément pour roues arrière

(*) Ruote posteriori di serie • Set rear wheels standard • Hinterräder Serienmäßig • Kit de ruedas posteriores de serie • Roues arrière de série

Di serie	Standard equipment	Serienmässig	Estándar	De série
<ul style="list-style-type: none"> Scatola di trasmissione con ruota libera PTO 1 3/8" Z6 Rotore con sistema di taglio lineare Castello fisso Singola fila di pettini rompitori Slitte d'appoggio regolabili in altezza Rullo ozioso posteriore regolabile in altezza (194 mm) Raschifango per pulizia rullo ozioso Scarico anteriore rullo ozioso Cofano apribile (solo per ispezione) Telaio con doppia lamiera Protezione anteriore a bandinelle Protezioni antinfortunistiche conformi alla normativa CE 	<ul style="list-style-type: none"> Gearbox with freewheel clutch PTO 1 3/8" Z6 Rotor with linear cutting system 3-point linkage fixed Single row counter-blades Height-adjustable skids Rear levelling roller height adjustable (194 mm) Scraper for rear levelling roller Discharge of the material over the levelling roller Opening hood (for inspection only) Double skinned frame Front protection with metal flaps Protective equipment as per EC safety rules 	<ul style="list-style-type: none"> Getriebe mit integriertem Freilauf PTO 1 3/8" Z6 Rotor mit linear Schnittsystem Anbaubock fest 1 Reihe Gegenschneide Höhenverstellbare Stützkufen Hintere Stützwalze höhenverstellbar (194 mm) Walzenabstreifer Entladung des Materials über die Walze Heckhaube (darf nur für Wartungsarbeiten geöffnet werden) Doppelwandiger Rahmen Frontschutz mit Metallklappen Unfallschutz nach EU-Vorschriften 	<ul style="list-style-type: none"> Caja de engranajes con rueda libre TDF 1 3/8" Z6 Rotor con sistema de corte lineal Arco de tercer punto fijo Rompedor Patines de apoyo regulable en altura Rodillo nivelador trasero (194 mm), con regulación en altura Limpiador montado en el rodillo nivelador trasero Descarga anterior al rodillo nivelador Portón trasero aperturable (solo para inspección) Interior del cuerpo de maquina, con doble chapa Protección delantera mediante placas metálicas Protecciones de seguridad de acuerdo con la norma CE 	<ul style="list-style-type: none"> Boîtier de transmission avec roue libre PDF 1 3/8" Z6 Rotor avec système de coupe linéaire Châssis fixe Simple rangée de peignes Patins d'appui réglables en hauteur Rouleau d'appui arrière réglable en hauteur (194 mm) Racleur pour le rouleau d'appui Capot ouvrant (pour inspection seulement) Caisson renforcé par blindage interne Protection avant avec volets métalliques Protections contre les accidents aux normes CE

TSF	MULCHER HEAVY DUTY WITH FIXED HITCH
TSF	MULCHGERÄTE: SCHWERE AUSFÜHRUNG MIT FESTER ANHÄNGUNG
TSF	TRITURADORA CON ENGANCHE FIJO
TSF	BROYEUR AVEC ATTELAGE FIXE



ORIGINAL MADE IN ITALY

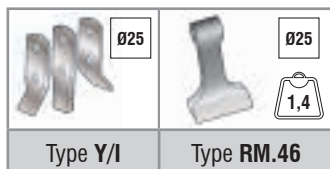
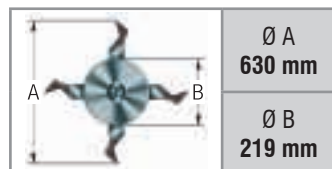

Sistema di taglio lineare
Linear cutting system
Linearroter
Sistema de corte lineal
Système de coupe linéaire

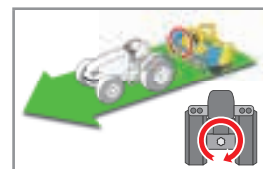

MOVEMENT MACHINE	
MOD	
mod.	cm
TSF 2000	117 105
TSF 2300	135 124
TSF 2700	153 141
TSF 3100	171 159

WORKING WIDTH	Standard		On request
	cm	nr	nr
200	40 + 20	20	3 + 3
230	48 + 24	24	3 + 3
270	56 + 28	28	4 + 4
310	64 + 32	32	5 + 5

cod.	A richiesta	On request	Auf Anfrage	Opcionales	Sur demande
5130009	Cardano T-60	PTO shaft T-60	Gelenkwelle T-60	Cardán T-60	Cardan T-60
5130010	Cardano T-70	PTO shaft T-70	Gelenkwelle T-70	Cardán T-70	Cardan T-70
2050079	Kit ruote posteriori in gomma sterzanti	Rear rubber steering wheels kit	Satz hintere Gummilenkräder	Kit de ruedas traseras, direccionales, en goma	Kit roues arrière directrices en caoutchouc
5226426	Aletta spargitrice dx	Spreading wing rh	Verteilerfluegel Rechts	Aleta esparciadora dx	Ailette de dispersion droite
5226427	Aletta spargitrice sx	Spreading wing lf	Verteilerfluegel Links	Aleta esparciadora sx	Ailette de dispersion gauche
5226431	Protezione laterale portellone	Protection side hood	Schutz-Seitenhaube	Protección lateral portón trasero	Protection latéral du porte arrière

cod.	Ricambi	Spare parts	Ersatzteile	Recambios	Pièces de rechange
5354045	Cinghia XPB-1800	Cug belt XPB-1800	Keilriemen XPB-1800	Correa XPB-1800	Courroie XPB-1800
5315116	Perno Ø25 per utensile	Ø25 pin for tool	Bolzen Ø25 für Werkzeug	Perno Ø25 para herramienta	Broche Ø25 pour outil
5350093	Mazza RM.46	Hammer RM.46	Hammer RM.46	Martillo RM.46	Marteau RM.46
5350095	Coltello "Y"	"Y" blade	"Y" Messer	Cuchilla "Y"	Couteau "Y"
5350094	Coltello "I"	"I" blade	"I" Messer	Cuchilla "I"	Couteau "I"
2020107	Scatola trasm. TSF 2000	Gear box TSF 2000	Getriebe TSF 2000	Caja de engranajes TSF 2000	Boîtier de transm. TSF 2000
2020119	Scatola trasm. TSF 2300	Gear box TSF 2300	Getriebe TSF 2300	Caja de engranajes TSF 2300	Boîtier de transm. TSF 2300
2020118	Scatola trasm. TSF 2700	Gear box TSF 2700	Getriebe TSF 2700	Caja de engranajes TSF 2700	Boîtier de transm. TSF 2700
2020044	Scatola trasm. TSF 3100	Gear box TSF 3100	Getriebe TSF 3100	Caja de engranajes TSF 3100	Boîtier de transm. TSF 3100



cod. 2050079
On request

Kit ruote posteriori
Rear wheel kit
Satz hinterräder
Kit ruedas posteriores
Kit roues arriere



Impiego	Use	Verwendung	Uso	Utilisation
---------	-----	------------	-----	-------------

La trinciastocchi TSF-PRO si presta in modo ottimale per la triturazione di paglia stocchi di mais e tralci in coltivazioni ortofrutticole, nei vigneti e nei vivai.

The TSF-PRO mulcher is ideal for mulching hay, maize stalks and horticultural crop waste in vineyards and plant nurseries.

Das TSF-PRO Mulchgerät eignet sich ideal zum Mulchen von Heu, Maisstoppeln und Gartenbauabfällen. Diese Version wird, im Gegensatz zum Vorgängermodell, mit seitlicher Verschiebung auf verchromten Rohren geliefert.

La trituradora TSF-PRO es excelente para triturar paja, tallos de maíz y ramas herbáceas en cultivos hortofrutícolas, viñedos y viveros.

Le broyeur de tiges TSF-PRO est particulièrement indiqué pour le broyage de chaumes, de tiges de maïs et de sarments dans les cultures maraichères, les vignes et les pépinières.



NEW

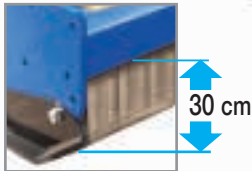
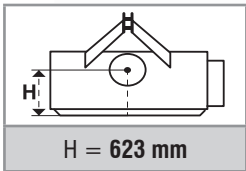

mod.	cod. Y/I	cod. RM.46	cod. Y/P	HP	rpm/min	type	nr (type)	cm	kg
TSF-PRO 1200	1003258	1003259	1003273	35 - 70	540	T-60	4 (XPB 1800)	147×160×104	750
TSF-PRO 1800	1003260	1003261	1003274	50 - 130	540	T-60	4 (XPB 1800)	204×160×104	890
TSF-PRO 2000	1003262	1003263	1003275	60 - 130	540	T-60	5 (XPB 1800)	224×160×104	955
TSF-PRO 2300	1003264	1003265	1003276	70 - 130	540	T-60	5 (XPB 1800)	254×160×104	1055
TSF-PRO 2500	1003266	1003267	1003277	80 - 150	540	T-70	5 (XPB 1800)	275×160×104	1135
TSF-PRO 2800	1003268	1003269	1003278	80 - 150	1000	T-70	6 (XPB 1800)	303×160×104	1240
TSF-PRO 3100	1003270	1003271	1003279	100 - 150	1000	T-70	6 (XPB 1800)	333×160×104	1380

Supplemento per ruote posteriori • Surcharge for rear wheels • Aufpreis für Hinterräder • Recargo de uedas posteriores • Supplément pour roues arrière

Di serie	Standard equipment	Serienmässig	Estándar	De série
<ul style="list-style-type: none"> • Rotore con sistema di taglio lineare • Attacco a 3 punti spostabile in 2 posizioni fisse • Doppia fila di pettini rompitori • Slitte d'appoggio regolabili in altezza • Rullo ozioso posteriore regolabile in altezza (194 mm) • Raschiafango per pulizia rullo ozioso • Scarico anteriore rullo ozioso • Cofano apribile (solo per ispezione) • Telaio con doppia lamiera • Protezione anteriore a bandinelle • Protezioni antinfortunistiche conformi alla normativa CE 	<ul style="list-style-type: none"> • Rotor with linear cutting system • 3-point hitch movable in 2 fixed positions • Double row counter-blades • Height-adjustable skids • Rear levelling roller height adjustable (194 mm) • Scraper for rear levelling roller • Discharge of the material over the levelling roller • Opening hood (for inspection only) • Double skinned frame • Front protection with metal flaps • Protective equipment as per EC safety rules 	<ul style="list-style-type: none"> • Rotor mit linear Schnittsystem • 3- Punkt Aufnahme verstellbar in 2 Starpositionen • 2 Reihen Gegenschneide • Höhenverstellbare Stützkufen • Hintere Stützwalze höhenverstellbar (194 mm) • Walzenabstreifer • Entladung des Materials über die Walze • Heckhaube (darf nur für Wartungsarbeiten geöffnet werden) • Doppelwandiger Rahmen • Frontschutz mit Metallklappen • Unfallschutz nach EU-Vorschriften 	<ul style="list-style-type: none"> • Rotor con sistema de corte lineal • Enganche de 3 puntos desplazable a 2 posiciones fijas • Doble fila de rompedores • Patines de apoyo regulable en altura • Rodillo nivelador trasero (194 mm), con regulación en altura • Limpiador montado en el rodillo nivelador trasero • Descarga anterior al rodillo nivelador • Portón trasero aperturable (solo para inspección) • Interior del cuerpo de maquina, con doble chapa • Protección delantera mediante placas metálicas • Protecciones de seguridad de acuerdo con la norma CE 	<ul style="list-style-type: none"> • Rotor avec système de coupe linéaire • Attelage 3 points pouvant être déplacé sur 2 positions fixes • Double rangée de peignes • Patins d'appui réglables en hauteur • Rouleau d'appui arrière réglable en hauteur (194 mm) • Racleur pour le rouleau d'appui • Ejection devant le rouleau d'appui • Capot ouvrant (pour inspection seulement) • Caisson renforcé par blindage interne • Protection avant avec volets métalliques • Protections contre les accidents aux normes CE

TSF-PRO	MULCHER HEAVY DUTY WITH SIDE SHIFT
TSF-PRO	MULCHGERÄTE: SCHWERE AUSFÜHRUNG MIT SEITLICHER VERSCHIEBUNG
TSF-PRO	TRITURADORA CON DESPLAZAMIENTO LATERAL
TSF-PRO	BROYEUR AVEC DÉPORT LATERAL HYDRAULIQUE



	Ø A 630 mm	 Type Y/I	 Type RM.46	 Type Y/P	 Type CC	 Sistema di taglio lineare Linear cutting system Linearroter Sistema de corte lineal Système de coupe linéaire
	Ø B 219 mm					

MOD	MOVEMENT MACHINE				WORKING WIDTH	Standard			On request			
	mod.	cm	cm	cm		nr Y/I	nr RM.46	nr Y/P	nr I/P	nr CC	nr	nr
TSF-PRO 1200	75	72	—	—	120	24 + 12	12	24 + 12	24 + 12	12	8	2 + 2
TSF-PRO 1800	106	98	65	139	180	36 + 18	18	36 + 18	36 + 18	18	12	2 + 2
TSF-PRO 2000	108	116	73	151	200	44 + 22	22	44 + 22	44 + 22	22	12	3 + 3
TSF-PRO 2300	131	123	96	158	230	48 + 24	24	48 + 24	48 + 24	24	14	3 + 3
TSF-PRO 2500	141	134	106	169	250	52 + 26	26	52 + 26	52 + 26	26	15	3 + 3
TSF-PRO 2800	155	148	120	183	280	60 + 30	30	60 + 30	60 + 30	30	18	4 + 4
TSF-PRO 3100	170	163	135	198	310	72 + 36	36	72 + 36	72 + 36	36	20	4 + 4

cod.	A richiesta	On request	Auf Anfrage	Opcionales	Sur demande
5130009	Cardano T-60	PTO shaft T-60	Gelenkwelle T-60	Cardán T-60	Cardan T-60
5130010	Cardano T-70	PTO shaft T-70	Gelenkwelle T-70	Cardán T-70	Cardan T-70
5210332	Aste di raccolta sarmenti	Twig rakes	Holzaufnahmezinken	Astas de cosecha	Tiges de ramassage
2050079	Kit ruote posteriori in gomma sterzanti	Rear rubber steering wheels kit	Satz hintere Gummilenkräder	Kit de ruedas traseras, en goma, direccionales	Kit roues arrière directrices en caoutchouc
5226426	Aletta spargitrice dx	Spreading wing rh	Verteilerfluegel Rechts	Aleta esparciadora izq.	Ailette de dispersion droite
5226427	Aletta spargitrice sx	Spreading wing lf	Verteilerfluegel Links	Aleta esparciadora dcha	Ailette de dispersion gauche
5226431	Protezione laterale portellone	Protection side hood	Schutz-Seitenhaube	Protección lateral portón trasero	Protection latéral du porte arrière

cod.	Ricambi	Spare parts	Ersatzteile	Recambios	Pièces de rechange
5354045	Cinghia XPB-1800	Cug belt XPB-1800	Keilriemen XPB-1800	Correa XPB-1800	Courroie XPB-1800
5315531	Vite Ø25 per utensile	Ø25 screw for tool	Ø25 Schraube für Werkzeug	Tornillo Ø25 para herramienta	Vis Ø25 pour outil
5323019	Dado M24 per utensile	M24 nut for tool	M24 Mutter für Werkzeug	Tuerca M24 para herramienta	Écrou M24 pour outil
5350093	Mazza RM.46	Hammer RM.46	Hammer RM.46	Martillo RM.46	Marteau RM.46
5350095	Coltello "Y"	"Y" blade	"Y" Messer	Cuchilla "Y"	Couteau "Y"
5350094	Coltello "I"	"I" blade	"I" Messer	Cuchilla "I"	Couteau "I"
5350218	Coltello a cucchiaio "CC"	"CC" blade	"CC" Messer	Cuchilla "CC"	Couteau "CC"
5350217	Paletta di ventilazione "P"	"P" Aeration tool	"P" Belüftungswerkzeug	Paleta de ventilación "P"	Balayette de ventilation "P"
2020034	Scatola trasm. TSF-PRO 1200	Gear box TSF-PRO 1200	Getriebe TSF-PRO 1200	Caja de engranajes TSF-PRO 1200	Boîtier de transm. TSF-PRO 1200
2020158	Sc. trasm. TSF-PRO 1800/2000	Gear box TSF-PRO 1800/2000	Getriebe TSF-PRO 1800/2000	Caja de engr. TSF-PRO 1800/2000	Boîtier de transm. TSF-PRO 1800/2000
2020107	Scatola trasm. TSF-PRO 2300	Gear box TSF-PRO 2300	Getriebe TSF-PRO 2300	Caja de engranajes TSF-PRO 2300	Boîtier de transm. TSF-PRO 2300
2020119	Scatola trasm. TSF-PRO 2500	Gear box TSF-PRO 2500	Getriebe TSF-PRO 2500	Caja de engranajes TSF-PRO 2500	Boîtier de transm. TSF-PRO 2500
2020117	Scatola trasm. TSF-PRO 2800	Gear box TSF-PRO 2800	Getriebe TSF-PRO 2800	Caja de engranajes TSF-PRO 2800	Boîtier de transm. TSF-PRO 2800
2020118	Scatola trasm. TSF-PRO 3100	Gear box TSF-PRO 3100	Getriebe TSF-PRO 3100	Caja de engranajes TSF-PRO 3100	Boîtier de transm. TSF-PRO 3100



cod. 2050079
On request
 Kit ruote posteriori
 Rear wheel kit
 Satz hinterräder
 Kit ruedas posteriores
 Kit roues arrière



TSF-PRO

Impiego

La trinciastocchi ZTS si presta in modo ottimale per la triturazione di paglia stocchi di mais e tralci in coltivazioni ortofrutticole, nei vigneti e nei vivai.

Use

The ZTS mulcher is ideal for mulching hay, maize stalks and horticultural crop waste in vineyards and plant nurseries.

Verwendung

Das ZTS Mulchgerät eignet sich ideal zum Mulchen von Heu, Maisstopeln und Gartenbauabfällen. Diese Version wird, im Gegensatz zum Vorgängermodell, mit seitlicher Verschiebung auf verchromten Rohren geliefert.

Uso

La trituradora ZTS es excelente para triturar paja, tallos de maíz y ramas herbáceas en cultivos hortofrutícolas, viñedos y viveros.

Utilisation

Le broyeur de tiges ZTS est particulièrement indiqué pour le broyage de chaumes, de tiges de maïs et de sarments dans les cultures maraîchères, les vignes et les pépinières.

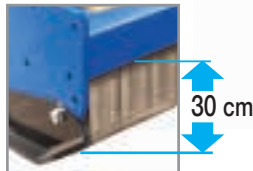
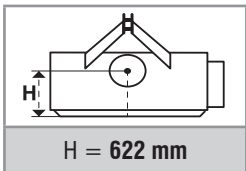

mod.	cod.	cod.	HP	rpm/min	type	nr (type)	cm	kg
ZTS 1800	1002740	1002741	50 - 130	540	T-60	4 (XPB 1800)	204×160×106	890
ZTS 2000	--	1002743	60 - 130	540	T-60	5 (XPB 1800)	224×160×106	955
ZTS 2300	1002744	1002745	70 - 130	540	T-60	5 (XPB 1800)	254×160×106	1055
ZTS 3100	1002748	--	100 - 150	1000	T-70	6 (XPB 1800)	334×160×106	1380

Supplemento per ruote posteriori • Surcharge for rear wheels • Aufpreis für Hinterräder • Recargo de ruedas posteriores • Supplément pour roues arrière

Di serie	Standard equipment	Serienmässig	Estándar	De série
<ul style="list-style-type: none"> Rotore con sistema di taglio lineare Spostamento su barre cromate Spostamento laterale meccanico Doppia fila di pettini rompitori Slitte d'appoggio regolabili in altezza Rullo ozioso posteriore regolabile in altezza (194 mm) Raschifango per pulizia rullo ozioso Scarico anteriore rullo ozioso Cofano apribile (solo per ispezione) Telaio con doppia lamiera Protezione anteriore a bandinelle Protezioni antinfortunistiche conformi alla normativa CE 	<ul style="list-style-type: none"> Rotor with linear cutting system Side shift on chrome bars Mechanical side shift Double row counter-blades Height-adjustable skids Rear levelling roller height adjustable (194 mm) Scraper for rear levelling roller Discharge of the material over the levelling roller Opening hood (for inspection only) Double skinned frame Front protection with metal flaps Protective equipment as per EC safety rules 	<ul style="list-style-type: none"> Rotor mit linear Schnittsystem Seitenverschiebung über Chromstangen Mechanische Seitenverschiebung 2 Reihen Gegenschneide Höhenverstellbare Stützkufen Hintere Stützwalze höhenverstellbar (194 mm) Walzenabstreifer Entladung des Materials über die Walze Heckhaube (darf nur für Wartungsarbeiten geöffnet werden) Doppelwandiger Rahmen Frontschutz mit Metallklappen Unfallschutz nach EU-Vorschriften 	<ul style="list-style-type: none"> Rotore con sistema de corte lineal Desplazamiento sobre tubo cromado Desplazamiento lateral mecánico Doble fila de rompedores Patines de apoyo regulable en altura Rodillo nivelador trasero (194 mm), con regulación en altura Limpiador montado en el rodillo nivelador trasero Descarga anterior al rodillo nivelador Portón trasero aperturable (solo para inspección) Interior del cuerpo de maquina, con doble chapa Protección delantera mediante placas metálicas Protecciones de seguridad de acuerdo con la norma CE 	<ul style="list-style-type: none"> Rotor avec système de coupe linéaire Déplacement avec barre chromée Déport latéral mécanique Double rangée de peignes Patins d'appui réglables en hauteur Rouleau d'appui arrière réglable en hauteur (194 mm) Racleur pour le rouleau d'appui Ejection devant le rouleau d'appui Capot ouvrant (pour inspection seulement) Caisson renforcé par blindage interne Protection avant avec volets métalliques Protections contre les accidents aux normes CE

ZTS	MULCHER HEAVY DUTY WITH SIDE SHIFT
ZTS	MULCHGERÄTE: SCHWERE AUSFÜHRUNG MIT SEITLICHER VERSCHIEBUNG
ZTS	TRITURADORA
ZTS	BROYEUR AVEC DÉPORT LATERAL HYDRAULIQUE



ORIGINAL MADE IN ITALY

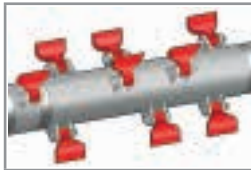
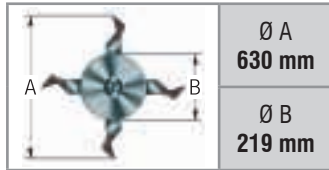

Sistema di taglio lineare
Linear cutting system
Linearrotor
Sistema de corte lineal
Système de coupe linéaire



MOD	MOVEMENT MACHINE					WORKING WIDTH	Standard		On request	
	cm		cm		cm		nr	nr	nr	nr
ZTS 1800	109	95	69	135	40	180	36 + 18	18	12	2 + 2
ZTS 2000	114	110	74	150	40	200	44 + 22	22	12	3 + 3
ZTS 2300	131	123	91	163	40	230	48 + 24	24	14	3 + 3
ZTS 3100	171	163	131	203	40	310	72 + 36	36	20	4 + 4

cod.	A richiesta	On request	Auf Anfrage	Opcionales	Sur demande
5130009	Cardano T-60	PTO shaft T-60	Gelenkwelle T-60	Cardán T-60	Cardan T-60
5130010	Cardano T-70	PTO shaft T-70	Gelenkwelle T-70	Cardán T-70	Cardan T-70
2050011	Gruppo spost. idr. 40 cm	Hydraulic side shift 40 cm	Hydraulische Verschiebung 40 cm	Kit desplazador hidr. 40 cm	Groupe de dépl. lat. 40 cm
5210332	Aste di raccolta sarmenti	Twig rakes	Holzaufnahmezinken	Astas de cosecha	Tiges de ramassage
2050079	Kit ruote posteriori in gomma sterzanti	Rear rubber steering wheels kit	Satz hintere Gummilenkräder	Kit de ruedas traseras, en goma, direccionales	Kit roues arrière directrices en caoutchouc
5226426	Aletta spargitrice dx	Spreading wing rh	Verteilerfluegel Rechts	Aleta esparciadora izq.	Ailette de dispersion droite
5226427	Aletta spargitrice sx	Spreading wing lf	Verteilerfluegel Links	Aleta esparciadora dcha	Ailette de dispersion gauche
5226431	Protezione laterale portellone	Protection side hood	Schutz-Seitenhaube	Protección lateral portón trasero	Protection latéral du porte arrière

cod.	Ricambi	Spare parts	Ersatzteile	Recambios	Pièces de rechange
5354045	Cinghia XPB-1800	Cug belt XPB-1800	Keilriemen XPB-1800	Correa XPB-1800	Courroie XPB-1800
5315531	Vite Ø25 per utensile	Ø25 screw for tool	Ø25 Schraube für Werkzeug	Tornillo Ø25 para herramienta	Vis Ø25 pour outil
5323019	Dado M24 per utensile	M24 nut for tool	M24 Mutter für Werkzeug	Tuerca M24 para herramienta	Ecrou M24 pour outil
5350093	Mazza RM.46	Hammer RM.46	Hammer RM.46	Martillo RM.46	Marteau RM.46
5350095	Coltello "Y"	"Y" blade	"Y" Messer	Cuchilla "Y"	Couteau "Y"
5350094	Coltello "I"	"I" blade	"I" Messer	Cuchilla "I"	Couteau "I"
2020158	Sc. trasm. ZTS 1800/2000	Gear box ZTS 1800/2000	Getriebe ZTS 1800/2000	Caja de engr. ZTS 1800/2000	Boîtier de transm. ZTS 1800/2000
2020107	Scatola trasm. ZTS 2300	Gear box ZTS 2300	Getriebe ZTS 2300	Caja de engranajes ZTS 2300	Boîtier de transm. ZTS 2300
2020118	Scatola trasm. ZTS 3100	Gear box ZTS 3100	Getriebe ZTS 3100	Caja de engranajes ZTS 3100	Boîtier de transm. ZTS 3100



cod. 2050079
On request
Kit ruote posteriori
Rear wheel kit
Satz hinterräder
Kit ruedas posteriores
Kit roues arriere



ZTS-DT

Impiego	Use	Verwendung	Uso	Utilisation
---------	-----	------------	-----	-------------

La trinciastocchi ZTS-DT si presta in modo ottimale per la triturazione di arbusti, paglia, stocchi di mais, residui del raccolto, materiale legnoso o organico presente sul terreno incolto.

The ZTS-DT mulcher is ideal for mulching bushes, straw, maize stalks, crop residues, woody or organic materials, which are to be found on fallow soil.

Das ZTS-DT ist ein Mulchgerät mit Doppelantrieb und eignet sich ideal zum Mulchen von Sträucher, Stroh, Kornstöcke, Kulturreste, Holz- oder organisches Material, das im unbestellten Boden vorhanden ist.

La trituradora ZTS-DT es excelente para triturar arbustos, paja, rastrojo de maíz, residuos de cultivos, material orgánico o leñoso en el páramo.

Le broyeur de tiges ZTS-DT est particulièrement indiqué pour le broyage des jachères, pailles, tiges de maïs, résidus de cultures, de bois, matière organiques présentes sur les terrains en friche.

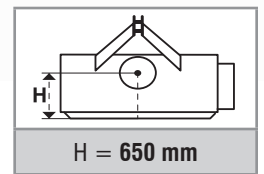
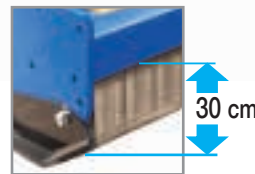

mod.	cod. Y/I	cod. RM.46	cod. Y/P	HP	rpm/min	type	nr (type)	cm	kg
ZTS-DT 3200	1003025	1003034	1003280	90 - 210	1000	T-90	4+4 (XPB 1750)	350×160×106	1520

Supplemento per ruote posteriori • Surcharge for rear wheels • Aufpreis für Hinterräder • Recargo de uedas posteriores • Supplément pour roues arrière

Di serie	Standard equipment	Serienmässig	Estándar	De série
<ul style="list-style-type: none"> Rotore con sistema di taglio lineare Doppia fila di pettini rompitori Slitte d'appoggio regolabili in altezza Rullo ozioso posteriore regolabile in altezza (194 mm) Raschifango per pulizia rullo ozioso Scarico anteriore rullo ozioso Cofano apribile (solo per ispezione) Telaio con doppia lamiera Protezione anteriore a bandinelle Protezioni antinfortunistiche conformi alla normativa CE 	<ul style="list-style-type: none"> Rotor with linear cutting system Double row counter-blades Height-adjustable skids Rear levelling roller height adjustable (194 mm) Scraper for rear levelling roller Discharge of the material over the levelling roller Opening hood (for inspection only) Double skinned frame Front protection with metal flaps Protective equipment as per EC safety rules 	<ul style="list-style-type: none"> Rotor mit linear Schnittsystem 2 Reihen Gegenschneide Höhenverstellbare Stützkufen Hintere Stützwalze höhenverstellbar (194 mm) Walzenabstreifer Entladung des Materials über die Walze Heckhaube (darf nur für Wartungsarbeiten geöffnet werden) Doppelwandiger Rahmen Frontschutz mit Metallklappen Unfallschutz nach EU-Vorschriften 	<ul style="list-style-type: none"> Rotor con sistema de corte lineal Doble fila de rompedores Patines de apoyo regulable en altura Rodillo nivelador trasero (194 mm), con regulación en altura Limpiador montado en el rodillo nivelador trasero Descarga anterior al rodillo nivelador Portón trasero aperturable (solo para inspección) Interior del cuerpo de maquina, con doble chapa Protección delantera mediante placas metálicas Protecciones de seguridad de acuerdo con la norma CE 	<ul style="list-style-type: none"> Rotor avec système de coupe linéaire Double rangée de peignes Patins d'appui réglables en hauteur Rouleau d'appui arrière réglable en hauteur (194 mm) Racleur pour le rouleau d'appui Ejection devant le rouleau d'appui Capot ouvrant (pour inspection seulement) Caisson renforcé par blindage interne Protection avant avec volets métalliques Protections contre les accidents aux normes CE

ZTS-DT	MULCHER-DT HEAVY DUTY WITH DOUBLE TRANSMISSION
ZTS-DT	MULCHGERÄTE-DT: SCHWERE AUSFÜHRUNG MIT DOPPELANTRIEB
ZTS-DT	TRITURADORA DT - TRACCIÓN DOBLE
ZTS-DT	BROYEUR-DT DOUBLE TRANSMISSION PAR COURROIES



ORIGINAL MADE IN ITALY

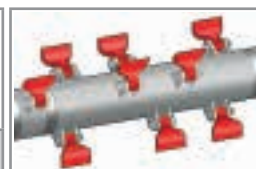
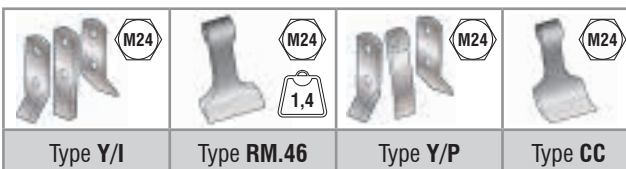
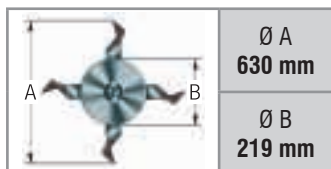

Sistema di taglio lineare
Linear cutting system
Linearroter
Sistema de corte lineal
Système de coupe linéaire

MOD	MOVEMENT MACHINE	WORKING WIDTH	Standard				On request			
			Type Y/I	Type RM.46	Type Y/P	Type CC	CC			
mod.	cm	cm	nr Y/I	nr RM.46	nr Y/P	nr I/P	nr CC	nr	nr	
ZTS-DT 3200	175	175	320	72 + 36	36	72 + 36	72 + 36	36	22	4 + 4

cod.	A richiesta	On request	Auf Anfrage	Opcionales	Sur demande
5130056	Cardano T-90 1-3/4"+1-3/4"	PTO shaft T-90 1-3/4"+1-3/4"	Gelenkwelle T-90 1-3/4"+1-3/4"	Cardán T-90 1-3/4"+1-3/4"	Cardan T-90 1-3/4"+1-3/4"
5210332	Aste di raccolta sarmenti	Twig rakes	Holzaufnahmezinken	Astas de cosecha	Tiges de ramassage
5226426	Aletta spargitrice dx	Spreading wing rh	Verteilerfluegel Rechts	Aleta esparciadora izq.	Ailette de dispersion droite
5226427	Aletta spargitrice sx	Spreading wing lf	Verteilerfluegel Links	Aleta esparciadora dcha	Ailette de dispersion gauche
2050079	Kit ruote posteriori in gomma sterzanti	Rear rubber steering wheels kit	Satz hintere Gummilenkräder	Kit de ruedas traseras, en goma, direccionales	Kit roues arrière directrices en caoutchouc
5226431	Protezione laterale portellone	Protection side hood	Schutz-Seitenhaube	Protección lateral portón trasero	Protection latéral du porte arrière

cod.	Ricambi	Spare parts	Ersatzteile	Recambios	Pièces de rechange
5354078	Cinghia XPB-1750	Cug belt XPB-1750	Keilriemen XPB-1750	Correa XPB-1750	Courroie XPB-1750
5315531	Vite M24 per utensile	M24 screw for tool	M24 Schraube für Werkzeug	Tornillo M24 para herramienta	Vis M24 pour outil
5323019	Dado M24 per utensile	M24 nut for tool	M24 Mutter für Werkzeug	Tuerca M24 para herramienta	Ecrou M24 pour outil
5350093	Mazza RM.46	Hammer RM.46	Hammer RM.46	Martillo RM.46	Marteau RM.46
5350095	Coltello "Y"	"Y" blade	"Y" Messer	Cuchilla "Y"	Couteau "Y"
5350094	Coltello "I"	"I" blade	"I" Messer	Cuchilla "I"	Couteau "I"
5350218	Coltello a cucchiaino "CC"	"CC" blade	"CC" Messer	Cuchilla "CC"	Couteau "CC"
5350217	Paletta di ventilazione "P"	"P" Aeration tool	"P" Belüftungswerkzeug	Paleta de ventilación "P"	Balayette de ventilation "P"
2020164	Scatola trasm. ZTS-DT 3200	Gear box ZTS-DT 3200	Getriebe ZTS-DT 3200	Caja de engranajes ZTS-DT 3200	Boîtier de transm. ZTS-DT 3200

cod. 2050079
On request

Kit ruote posteriori
Rear wheel kit
Satz hinterräder
Kit ruedas posteriores
Kit roues arriere

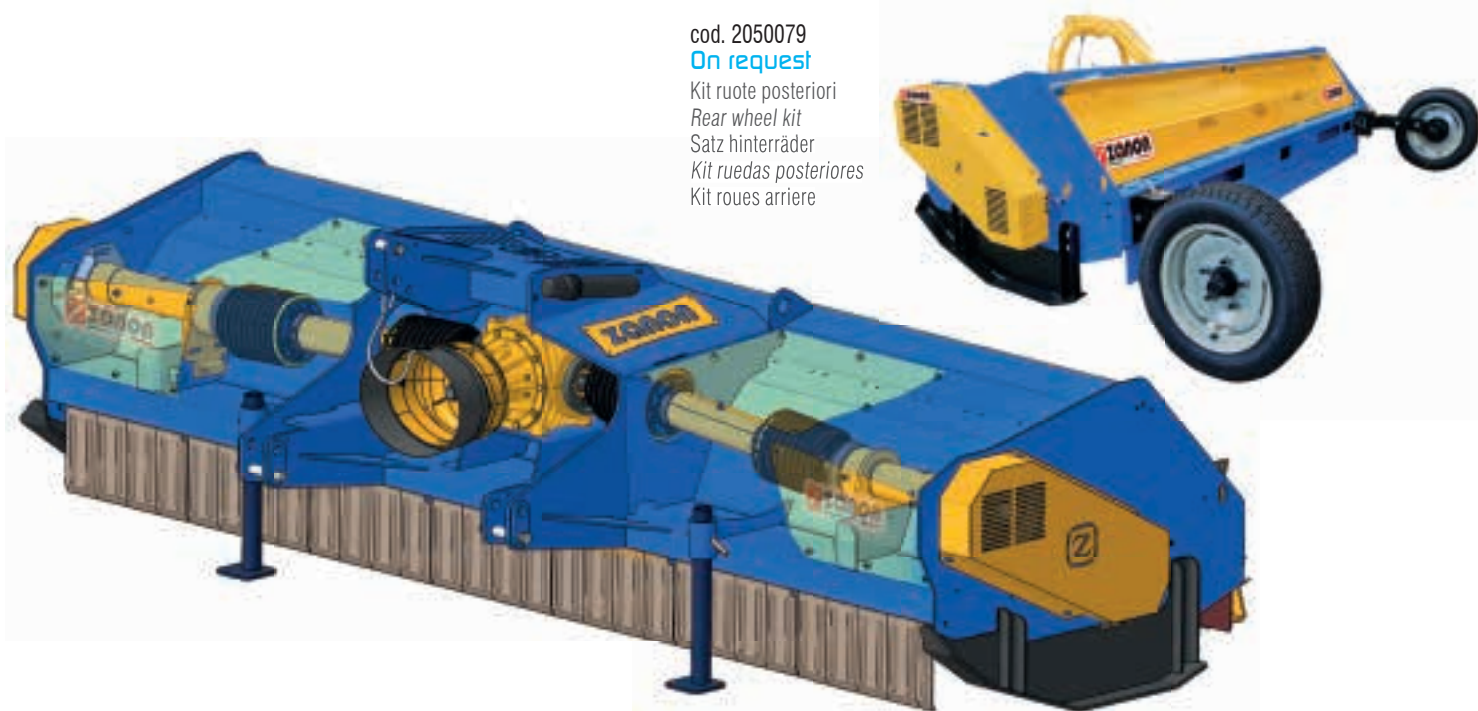

ZTS-DT

Impiego	Use	Verwendung	Uso	Utilisation
---------	-----	------------	-----	-------------

La trinciastocchi ZTS-MEGA è una macchina polivalente adatta alla frantumazione di paglia, stocchi di mais e per la manutenzione del maggese. È indicata per la lavorazione di grandi distese di terreno e per le grandi aziende. Può essere dotata di sistema di traino per agevolare lo spostamento.

The ZTS-MEGA is a multi-purpose machine for shredding straw, maize stalks and grass, and for fallow field management. It's ideal for large areas of land and large farms. It can be equipped with a towing system for easy transport.









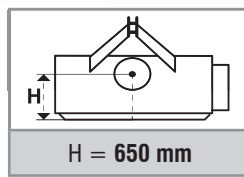
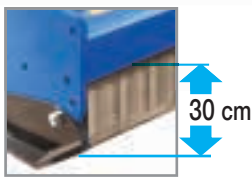
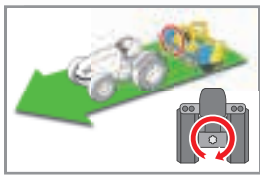

Der Mulcher ZTS-MEGA ist ein vielseitiges Gerät für die Zerkleinerung von Stroh und Maisstroh sowie für die Pflege von Wiesen und Brachland. Er ist speziell für die Bearbeitung großer Bodenflächen und für große landwirtschaftliche Betriebe geeignet. Es kann mit einem Zugsystem ausgestattet werden, um den Transport zu erleichtern.



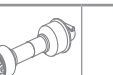

La trituradora ZTS-MEGA es un máquina con múltiples usos, apta para triturar paja, tallos de maíz y para el mantenimiento del barbecho. Es indicada para trabajar en grandes extensiones y para las grandes explotaciones agrarias. Puede equiparse con un sistema de remolque para facilitar el transporte.

Le broyeur de tiges ZTS-MEGA est une machine polyvalente qui permet de broyer la paille, les tiges de maïs et d'entretenir les jachères. Il est adapté au travail sur de grandes surfaces et aux grandes exploitations. Il peut être équipé d'un système de remorquage pour faciliter le transport.

NEW

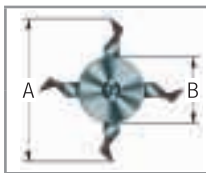
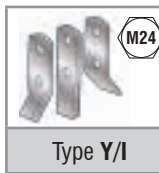

									
mod.	cod. RM.46	cod. Y/I	cod. Y/P	HP	rpm/min	type	nr (type)	cm	kg
ZTS-MEGA 4600	1003879	1003296	1003297	120 - 180	1000	T-90	5+5 (XB 1750)	478×160×106	2400

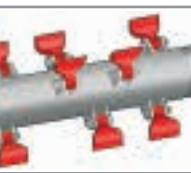
	<p>Ø A 630 mm</p> <p>Ø B 219 mm</p>						<p>Sistema di taglio lineare Linear cutting system Linearrotor Sistema de corte lineal Système de coupe linéaire</p>
		Type Y/I	Type RM.46	Type Y/P	Type CC		

Di serie	Standard equipment	Serienmässig	Estándar	De série
<ul style="list-style-type: none"> • Rotore con sistema di taglio lineare • Doppia fila di pettini rompitori • Slitte d'appoggio regolabili in altezza • Scarico anteriore rullo ozioso • Cofano apribile (solo per ispezione) • Telaio con doppia lamiera • Protezione anteriore a bandinelle • Ruote d'appoggio posteriori • Protezioni antinfortunistiche conformi alla normativa CE 	<ul style="list-style-type: none"> • Rotor with linear cutting system • Double row counter-blades • Height-adjustable skids • Discharge of the material over the levelling roller • Opening hood (for inspection only) • Double skinned frame • Front protection with metal flaps • Rear support wheels • Protective equipment as per EC safety rules 	<ul style="list-style-type: none"> • Rotor mit linear Schnittsystem • 2 Reihen Gegenschneide • Höhenverstellbare Stützkufen • Entladung des Materials über die Walze • Heckhaube (darf nur für Wartungsarbeiten geöffnet werden) • Doppelwandiger Rahmen • Frontschutz mit Metallklappen • Hintere Stützräder • Unfallschutz nach EU-Vorschriften 	<ul style="list-style-type: none"> • Rotor con sistema de corte lineal • Doble fila de rompedores • Patines de apoyo regulable en altura • Descarga anterior al rodillo nivelador • Portón trasero aperturable (solo para inspección) • Interior del cuerpo de maquina, con doble chapa • Protección delantera mediante placas metálicas • Ruedas de apoyo traseras • Protecciones de seguridad de acuerdo con la norma CE 	<ul style="list-style-type: none"> • Rotor avec système de coupe linéaire • Double rangée de peignes • Patins d'appui réglables en hauteur • Ejection devant le rouleau d'appui • Capot ouvrant (pour inspection seulement) • Caisson renforcé par blindage interne • Protection avant avec volets métalliques • Roues de support arrière • Protections contre les accidents aux normes CE

ZTS-MEGA	MULCHER HEAVY DUTY WITH DOUBLE TRANSMISSION
ZTS-MEGA	MULCHGERÄTE: SCHWERE AUSFÜHRUNG MIT DOPPELANTRIEB
ZTS-MEGA	TRITURADORA - TRACCIÓN DOBLE
ZTS-MEGA	BROYEUR DOUBLE TRANSMISSION PAR COURROIES



MOD	MOVEMENT MACHINE		WORKING WIDTH	Standard			On request		
	mod.	cm	cm	nr RM.46	nr Y/I	nr Y/P	nr I/P	nr CC	nr
ZTS-MEGA 4600	253	253	460	48	96	48 + 96	48 + 96	48	6 + 6

cod.	A richiesta	On request	Auf Anfrage	Opcionales	Sur demande
5130056	Cardano T-90 1-3/4"+1-3/4"	PTO shaft T-90 1-3/4"+1-3/4"	Gelenkwelle T-90 1-3/4"+1-3/4"	Cardán T-90 1-3/4"+1-3/4"	Cardan T-90 1-3/4"+1-3/4"
5130083	Cardano T-90 1-3/4"+1-3/8"	PTO shaft T-90 1-3/4"+1-3/8"	Gelenkwelle T-90 1-3/4"+1-3/8"	Cardán T-90 1-3/4"+1-3/8"	Cardan T-90 1-3/4"+1-3/8"
5226426	Aletta spargitrice dx	Spreading wing rh	Verteilerfluegel Rechts	Aleta esparciadora izq.	Ailette de dispersion droite
5226427	Aletta spargitrice sx	Spreading wing lf	Verteilerfluegel Links	Aleta esparciadora dcha	Ailette de dispersion gauche
① 2051354	Kit ruote posteriori (nr.2)	Rear wheel kit (no.2)	Hinterradsatz (Nr. 2)	Kit de rueda trasera (nº 2)	Kit de roues arrière (no.2)
② 2051355	Kit traino stradale (barra luci e timone di traino con pistone idraulico) Attenzione: non omologato per la circolazione su strade europee.	Road towing kit (light bar and drawbar with hydraulic piston) Warning: not approved for circulation on European roads.	Abschleppkit für die Straße (Lichtbalken und Deichsel mit Hydraulikkolben) Achtung: nicht für den Verkehr auf europäischen Straßen zugelassen.	Kit para remolque en carretera (barra de luces y lanza con pistón hidráulico) Atención no homologado para circular en carreteras Europeas	Kit de remorquage routier (barre lumineuse et barre d'attelage avec piston hydraulique) Avertissement: non homologué pour la circulation sur les routes européennes.
③ 2051356	Kit traino in lavoro Attacco a 3 punti Cat. III	Work towing kit 3-point linkage cat. III	Bausatz für Arbeitsabschleppung 3-Punkt-Anbau Kat. III	Kit de remolque para trabajo Enganche a 3 punto Cat. III	Kit de remorquage de travail Attelage 3 points Cat. III
④ 2051357	Kit apertura idraulica cofano	Hydraulic bonnet opening kit	Hydraulischer Motorhaubenöffnungssatz	Kit de apertura hidráulica de la puerta trasera	Kit d'ouverture hydraulique du capot
5226431	Protezione laterale portellone	Protection side hood	Schutz-Seitenhaube	Protección lateral portón trasero	Protection latéral du porte arrière
2051358	Rullo ozioso posteriore regolabile in altezza (194 mm) con raschiafango	Rear levelling roller height adjustable (194 mm) with scraper	Hintere Stützwalze höhenverstellbar (194 mm) mit Walzenabstreifer	Rodillo nivelador trasero (194 mm), con regulación en altura con limpiador	Rouleau d'appui arrière réglable en hauteur (194 mm) avec racleur

cod.	Ricambi	Spare parts	Ersatzteile	Recambios	Pièces de rechange
5354078	Cinghia XPB-1750	Cug belt XPB-1750	Keilriemen XPB-1750	Correa XPB-1750	Courroie XPB-1750
5315531	Vite M24 per utensile	M24 screw for tool	M24 Schraube für Werkzeug	Tornillo M24 para herramienta	Vis M24 pour outil
5323019	Dado M24 per utensile	M24 nut for tool	M24 Mutter für Werkzeug	Tuerca M24 para herramienta	Ecrou M24 pour outil
5350093	Mazza RM.46	Hammer RM.46	Hammer RM.46	Martillo RM.46	Marteau RM.46
5350095	Coltello "Y"	"Y" blade	"Y" Messer	Cuchilla "Y"	Couteau "Y"
5350094	Coltello "I"	"I" blade	"I" Messer	Cuchilla "I"	Couteau "I"
5350218	Coltello a cucchiaino "CC"	"CC" blade	"CC" Messer	Cuchilla "CC"	Couteau "CC"
5350217	Paletta di ventilazione "P"	"P" Aeration tool	"P" Belüftungswerkzeug	Paleta de ventilación "P"	Balayette de ventilation "P"
2020164	Scatola trasm. ZTS-MEGA	Gear box ZTS-MEGA	Getriebe ZTS-MEGA	Caja de engranajes ZTS-MEGA	Boîtier de transm. ZTS-MEGA

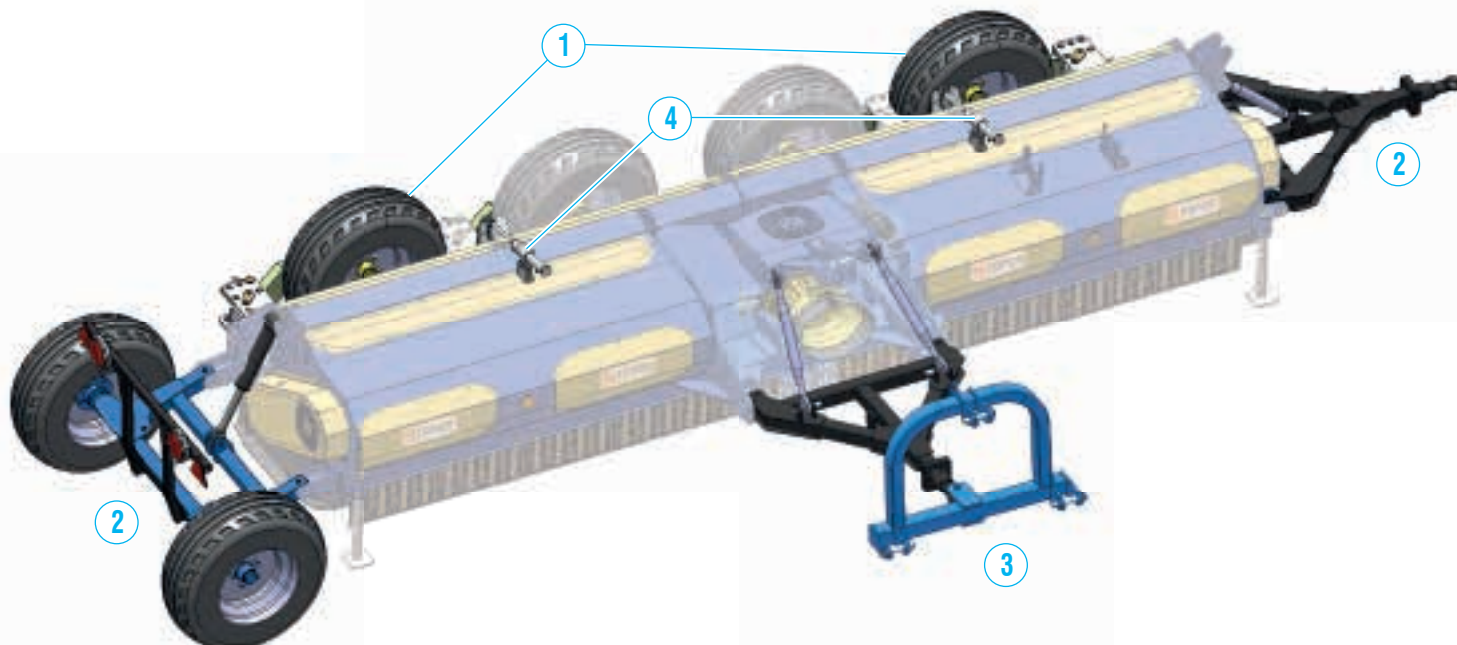

ZTS-MEGA

Impiego Use Verwendung Uso Utilisation

La trinciastocchi pieghevole ZTS TWIN è una macchina dai molteplici utilizzi, adatta alla frantumazione di paglia, stocchi di mais, per praterie, e per la manutenzione del maggese. È indicata per la lavorazione di grandi distese di terreno e per le grandi aziende.

The ZTS TWIN is a multi-purpose machine for shredding straw, maize stalks and grass, and for fallow field management. The ZTS TWIN is ideal for large areas of land and large farms.

Der klappbare Mulcher ZTS TWIN ist ein vielseitiges Gerät für die Zerkleinerung von Stroh und Maisstroh sowie für die Pflege von Wiesen und Brachland. Er ist speziell für die Bearbeitung großer Bodenflächen und den Einsatz in landwirtschaftlichen Großbetrieben geeignet.

La trituradora plegable ZTS TWIN es un máquina con múltiples usos, apta para triturar paja, tallos de maíz, para prados y para el mantenimiento del barbecho. Es indicada para trabajar en grandes extensiones de tierra y para las grandes explotaciones.

Le broyeur repliable ZTS TWIN est une machine polyvalente, pouvant être utilisée pour le broyage de paille, tiges de maïs, herbe, et pour l'entretien des jachères. Il est indiqué pour travailler sur de grandes étendues de terrain et pour les grandes exploitations.

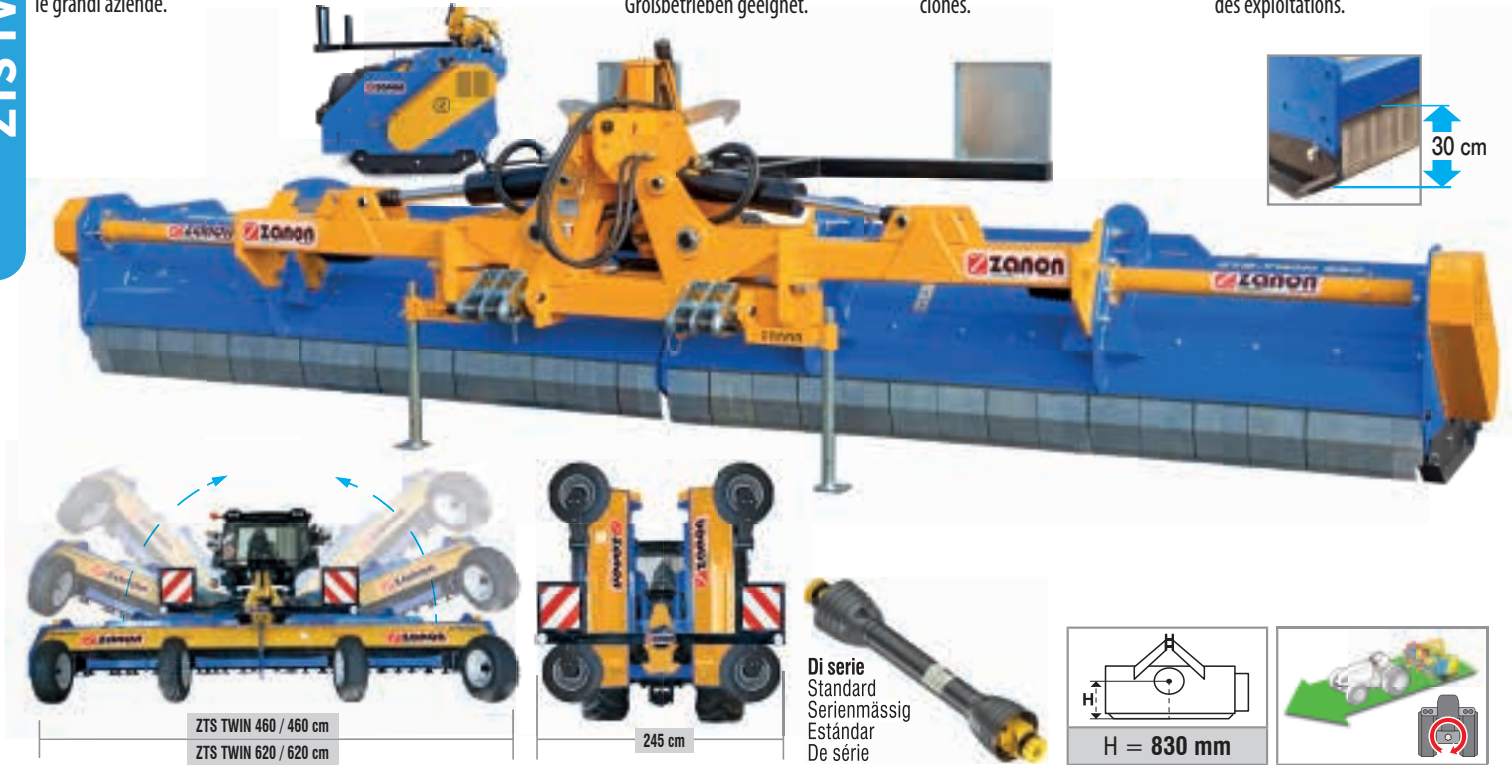

mod.	cod. Y/I	cod. RM.46	cod. Y/P	HP	rpm/min	type	nr (type)	cm	kg
ZTS TWIN 460	1003013	1003011	1003281	100 - 280	1000	T-90	5+5 (XPB 1900)	495×220×156	2700
ZTS TWIN 620	1003014	1003012	1003282	120 - 280	1000	T-90	6+6 (XPB 1900)	655×220×156	3100

Di serie	Standard equipment	Serienmässig	Estándar	De série
<ul style="list-style-type: none"> Scatola di trasmissione con ruota libera PTO 1 3/4" Z6 Cardano Rotore con sistema di taglio lineare Castello fisso Doppia fila di pettini rompitori imbullonati e regolabili Slitte d'appoggio regolabili in altezza Rullo ozioso posteriore regolabile in altezza (273 mm) Raschifango per pulizia rullo ozioso Scarico anteriore rullo ozioso Cofano apribile (solo per ispezione) Lamiera antiusura anteriore Protezione posteriore in gomma Protezione anteriore a bandinelle Barra fanali Protezioni antinfortunistiche conformi alla normativa CE 	<ul style="list-style-type: none"> Gearbox with freewheel clutch PTO 1 3/4" Z6 PTO drive shaft Rotor with linear cutting system 3-point linkage fixed Double row of bolted and adjustable counter blades Height-adjustable skids Rear levelling roller height adjustable (273 mm) Scraper for rear levelling roller Discharge of the material over the levelling roller Opening hood (for inspection only) Wear plate front attachment Rear protection with rubber Front protection with metal flaps Lighting equipment Protective equipment as per EC safety rules 	<ul style="list-style-type: none"> Getriebe mit Freilauf PTO 1 3/4" Z6 Gelenkwelle Rotor mit linear Schnittsystem Anbaubock fest Doppelte Reihe verschraubter und einstellbarer Gegenschnitten Höhenverstellbare Stützkufen Hintere Stützwalze höhenverstellbar (273 mm) Walzenabstreifer Entladung des Materials über die Walze Heckhaube (darf nur für Wartungsarbeiten geöffnet werden) Verschleißplatten für Frontgehäuse Hinterer Gummischutz Frontschutz mit Metallklappen Heckbeleuchtung Unfallschutz nach EU-Vorschriften 	<ul style="list-style-type: none"> Caja de engranajes con rueda libre interna, TDF 1 3/4" Z6 Transmisión cardanica Rotor con sistema de corte lineal Arco de tercer punto fijo Doble fila de rompedores atornillados y regulables Patines de apoyo regulable en altura Rodillo nivelador trasero (273 mm), con regulación en altura Limpiador montado en el rodillo nivelador trasero Descarga anterior al rodillo nivelador Portón trasero aperturable (solo para inspección) Placa anti desgaste delantera Protección posterior en goma Protección delantera mediante placas metálicas Barra de luces Protecciones de seguridad de acuerdo con la norma CE 	<ul style="list-style-type: none"> Boîtier de transmission avec roue libre PDF 1 3/8" Z6 Cardan Rotor avec système de coupe linéaire Châssis fixe Double rangée de peignes boulonnés et réglables Patins d'appui réglables en hauteur Rouleau d'appui arrière réglable en hauteur (273 mm) Racleur pour le rouleau d'appui Ejection devant le rouleau d'appui Capot ouvrant (pour inspection seulement) Plaque avant anti-usure Protection arrière en caoutchouc Protection frontaux par volets métalliques Kit éclairage Protections contre les accidents aux normes CE

ZTS TWIN	FOLDABLE MULCHER
ZTS TWIN	HECKANBAU KLAPPBARE MULCHGERÄTE
ZTS TWIN	TRITURADORA PLEGABLE
ZTS TWIN	BROYEUR REPLIABLE

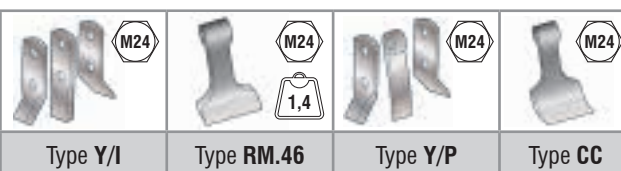
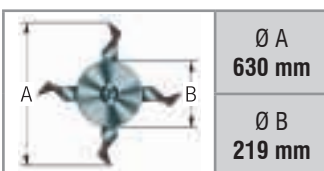

Sistema di taglio lineare
Linear cutting system
Linearrotor
Sistema de corte lineal
Système de coupe linéaire

MOD	MOVEMENT MACHINE	WORKING WIDTH	Standard				On request		
			cm	nr Y/I	nr RM.46	nr Y/P	nr I/P	nr CC	nr
ZTS TWIN 460	247	247	460	96	48	48 + 96	48 + 96	48	6 + 6
ZTS TWIN 620	327	327	620	144	72	72 + 144	72 + 144	72	8 + 8

cod.	A richiesta	On request	Auf Anfrage	Opcionales	Sur demande
5350216	Coltello "J"	"J" blade	"J" Messer	Cuchilla "J"	Couteau "J"
2050707	Kit ruote posteriori in gomma sterzanti	Rear rubber steering wheels kit	Satz hintere Gummilenkräder	Kit de ruedas traseras, direccionales, en goma	Kit roues arrière directrices en caoutchouc
5223881	Aletta spargitrice dx	Spreading wing rh	Verteilerfluegel Rechts	Aleta esparciadora izq.	Ailette de dispersion droite
5223882	Aletta spargitrice sx	Spreading wing lf	Verteilerfluegel Links	Aleta esparciadora dcha	Ailette de dispersion gauche
2050708	Kit rasaerba	Kit mowers	Kit-Mäher	Kit desbrozadora	Kit tondeuse à disc

cod.	Ricambi	Spare parts	Ersatzteile	Recambios	Pièces de rechange
5130056	Cardano T-90 1-3/4"+1-3/4"	PTO shaft T-90 1-3/4"+1-3/4"	Gelenkwelle T-90 1-3/4"+1-3/4"	Cardán T-90 1-3/4"+1-3/4"	Cardan T-90 1-3/4"+1-3/4"
5354094	Cinghia XPB-1900	Cug belt XPB-1900	Keilriemen XPB-1900	Correa XPB-1900	Courroie XPB-1900
5315531	Perno porta mazza Ø.25	Hammer support Ø.25	Hammer-unterstützung Ø.25	Soporte martillo Ø.25	Support de marteau Ø.25
5323019	Dado M24 per utensile	M24 nut for tool	M24 Mutter für Werkzeug	Tuerca M24 para herramienta	Ecrou M24 pour outil
5350093	Mazza RM.46	Hammer RM.46	Hammer RM.46	Martillo RM.46	Marteau RM.46
5350095	Coltello "Y"	"Y" blade	"Y" Messer	Cuchilla "Y"	Couteau "Y"
5350094	Coltello "I"	"I" blade	"I" Messer	Cuchilla "I"	Couteau "I"
5350218	Coltello a cucchiaio "CC"	"CC" blade	"CC" Messer	Cuchilla "CC"	Couteau "CC"
5350217	Paletta di ventilazione "P"	"P" Aeration tool	"P" Belüftungswerkzeug	Paleta de ventilación "P"	Balayette de ventilation "P"
5220364	Distanziale coltelli	Blades spacer	Messer Abstandshalter	Espaciador de cuchilla	Entretoise couteaux

cod. 2050707
On request
Kit ruote posteriori
Rear wheel kit
Satz hinterräder
Kit ruedas posteriores
Kit roues arriere



cod. 2050708
On request
Kit rasaerba
Kit mowers
Kit-Mäher
Kit desbrozadora
Kit tondeuse à disc



Impiego Use Verwendung Uso Utilisation

La TRE-PRO è una macchina pensata per la triturazione di sarmenti, erba, paglia, mais, tabacco, carciofi, bietole, cotone, e molto altro ancora. La TRE-PRO è caratterizzata da un ampio spostamento laterale che le permette di lavorare esternamente alla traiettoria del trattore, semplificando la pulizia di terreni con una folta vegetazione e difficilmente raggiungibili.







The TRE-PRO mulcher is thought for mulching twigs, maize, grass, hay, tobacco, artichokes, beet, cotton, and more besides. The TRE-PRO mulcher features an extended lateral movement that allows it to work to the side of the tractor, simplifying mulching operations on thick vegetation that might otherwise be difficult to reach.

Das TRE-PRO Mulchgerät eignet sich zum Mulchen von Zweigen, Mais, Gras, Heu und vielem mehr. Das TRE-PRO Mulchgerät zeichnet sich durch eine verlängerte Seitenbewegung aus, die es ermöglicht, seitlich vom Traktor zu arbeiten, wodurch das Mulchen von dichtem Bewuchs, der sonst schwer zu erreichen wäre, vereinfacht wird.

Es excelente para triturar sarmientos, maíz, hierba, paja, tabaco, alcachofas, remolachas, algodón y mucho más. La TRE-PRO se caracteriza por un amplio desplazamiento lateral que permite trabajar fuera de la trayectoria del tractor, lo que simplifica la limpieza de terrenos con una vegetación espesa y difícil de alcanzar.

Il est particulièrement indiqué pour le broyage de sarments, maïs, herbe, paille, tabac, artichauts, bettes, coton, et de nombreux autres végétaux. La TRE-PRO est caractérisée par un ample déport latéral qui lui permet de travailler hors de la trajectoire du tracteur, en simplifiant le nettoyage des terrains avec une végétation dense et difficiles d'accès.

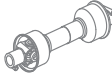
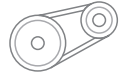

								
mod.	cod.	cod.	HP	rpm/min	type	nr (type)	cm	kg
TRE-PRO 2100	1002967	1002965	70 - 130	540/1000	T-60	5 (XPB 1690)	235×120×105	1045
TRE-PRO 2300	1002966	1002964	80 - 130	540/1000	T-70	5 (XPB 1690)	260×120×105	1095
TRE-PRO 2500	1002973	1002974	90 - 130	540/1000	T-70	5 (XPB 1690)	290×120×105	1145

Di serie	Standard equipment	Serienmässig	Estándar	De série
<ul style="list-style-type: none"> Scatola di trasmissione con ruota libera PTO 1 3/8" Z6 Rotore con sistema di taglio lineare Spostamento su barre cromate Spostamento laterale idraulico Doppia fila di pettini rompitori Aste di raccolta sarmenti Slitte d'appoggio regolabili in altezza Ruota d'appoggio regolabile in altezza Rullo ozioso posteriore regolabile in altezza (194 mm) Raschifango per pulizia rullo ozioso Scarico anteriore rullo ozioso Telaio con doppia lamiera Protezione anteriore a bandinelle Protezioni antinfortunistiche conformi alla normativa CE 	<ul style="list-style-type: none"> Gearbox with freewheel clutch PTO 1 3/8" Z6 Rotor with linear cutting system Side shift on chrome bars Hydraulic side shift Double row counter-blades Self levelling blade Height-adjustable skids Height-adjustable wheel Rear levelling roller height adjustable (194 mm) Scraper for rear levelling roller Discharge of the material over the levelling roller Double skinned frame Front protection with metal flaps Protective equipment as per EC safety rules 	<ul style="list-style-type: none"> Getriebe mit integriertem Freilauf PTO 1 3/8" Z6 Rotor mit linear Schnittsystem Seitenverschiebung über Chromstangen Hydraulische Seitenverschiebung 2 Reihen Gegenschneide Holzrechen Höhenverstellbare Stützkufen Höhenverstellbares Rad Hintere Stützwalze höhenverstellbar (194 mm) Walzenabstreifer Entladung des Materials über die Walze Doppelwandiger Rahmen Frontschutz mit Metallklappen Unfallschutz nach EU-Vorschriften 	<ul style="list-style-type: none"> Caja de engranajes con rueda libre TDF 1 3/8" Z6 Rotor con sistema de corte lineal Desplazamiento sobre tubo cromado Desplazamiento lateral hidráulico Doble fila de rompedores Rastrillo recoge sarmentos Patines de apoyo regulable en altura Rueda con regulación en altura Rodillo nivelador trasero (194 mm), con regulación en altura Limpiador montado en el rodillo nivelador trasero Descarga anterior al rodillo nivelador Interior del cuerpo de maquina, con doble chapa Protección delantera mediante placas metálicas Protecciones de seguridad de acuerdo con la norma CE 	<ul style="list-style-type: none"> Boîtier de transmission avec roue libre PDF 1 3/8" Z6 Rotor avec système de coupe linéaire Déplacement avec barre chromée Déport latéral hydraulique Double rangée de peignes Tige de ramassage Patins d'appui réglables en hauteur Roues de support réglables en hauteur Rouleau d'appui arrière réglable en hauteur (194 mm) Racleur pour le rouleau d'appui Ejection devant le rouleau d'appui Caisson renforcé par blindage interne Protection avant avec volets métalliques Protections contre les accidents aux normes CE

TRE-PRO	MULCHER HEAVY DUTY WITH LATERAL MOVEMENT
TRE-PRO	MULCHGERÄTE SCHWERE AUSFÜHRUNG
TRE-PRO	TRITURADORA PESADA CON DESPLAZAMIENTO LATERAL
TRE-PRO	BROYEUR LOURD AVEC DÉPORT LATÉRAL



ORIGINAL MADE IN ITALY

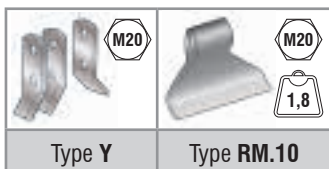
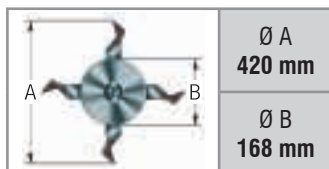

Sistema di taglio lineare
Linear cutting system
Linearrotor
Sistema de corte lineal
Système de coupe linéaire

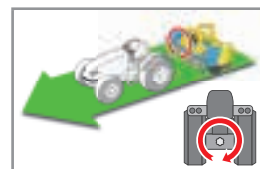

MOD	MOVEMENT MACHINE							WORKING WIDTH		Standard		
	mod.	cm	cm	cm	cm	cm	cm	nr	nr	nr	nr	
TRE-PRO 2100	--	53	172	50	52	210	90	210	54	18	18	
TRE-PRO 2300	--	53	192	50	52	230	90	230	60	20	20	
TRE-PRO 2500	--	53	222	50	52	250	90	250	66	22	23	

cod.	A richiesta	On request	Auf Anfrage	Opcionales	Sur demande
5130009	Cardano T-60	PTO shaft T-60	Gelenkwelle T-60	Cardán T-60	Cardan T-60
5130010	Cardano T-70	PTO shaft T-70	Gelenkwelle T-70	Cardán T-70	Cardan T-70
2050091	Kit ruote posteriori in gomma pivotanti	Rear pivoting rubber wheels kit	Satz hintere schwenkbare Gummiräder	Kit de ruedas traseras en goma, pivotantes	Kit roues arrière pivotantes en caoutchouc

cod.	Ricambi	Spare parts	Ersatzteile	Recambios	Pièces de rechange
5354058	Cinghia XPB-1690	Cug belt XPB-1690	Keilriemen XPB-1690	Correa XPB-1690	Courroie XPB-1690
5315093	Vite M20 per utensile	M20 screw for tool	M20 Schraube für Werkzeug	Tornillo M20 para herramienta	Vis M20 pour outil
5323018	Dado M20 per utensile	M20 nut for tool	M20 Mutter für Werkzeug	Tuerca M20 para herramienta	Ecrou M20 pour outil
5350038	Mazza RM.10	Hammer RM.10	Hammer RM.10	Martillo RM.10	Marteau RM.10
5350040	Coltello "Y"	"Y" blade	"Y" Messer	Cuchilla "Y"	Couteau "Y"
2020160	Scatola trasmissione	Gear box	Getriebe	Caja de engranajes	Boîtier de transmission



Impiego **Use** **Verwendung** **Uso** **Utilisation**

La trinciaerba reversibile TRL è una macchina studiata per essere applicata a trattori di medio-bassa potenza (25-80 HP), sia frontalmente sia posteriormente. Si presta in modo ottimale per la triturazione di sarmenti, erba, sterpaglie, paglia, e molto altro.

The TRL reversible mulcher is designed for front or rear mounting on low to medium power tractors (25 to 80 HP). It is ideal for mulching grass, maize, hay, pruning waste (in olive groves, orchards, etc.), brushwood and more besides.

Das TRL Mulchgerät ist für den Front- und Heckanbau an Traktoren mit niedriger bis mittlerer Leistung (25 bis 80 HP) ausgelegt. Es eignet sich ideal zum Mulchen von Gras, Grünfläche, Wiesen, Büsche und Gestrüpp. Das Mulcher TFL/R ist ein kompaktes, aber robustes und zuverlässiges Modell.

La trituradora reversible TRL es una máquina diseñada para ser aplicada en la parte delantera o trasera de los tractores de potencia medio baja (25-80 HP). Es excelente para la trituración de hierba, maíz, paja, residuos de poda (en oliveras, frutales, etc.), malezas y mucho más.

Le broyeur d'herbe réversible TRL est conçu pour être monté sur des tracteurs de moyenne-basse puissance (25-80 HP), aussi bien à l'avant qu'à l'arrière. Il est particulièrement indiqué pour le broyage d'herbe, maïs, paille, déchets d'élagage (dans les oliveraies, les vergers, etc.), de broussailles et autres végétaux.

NEW

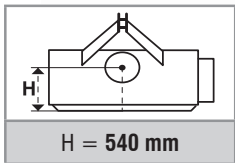

mod.	cod.	cod.	HP	rpm/min	type	nr (type)	cm	kg
TRL 1300	1003997	1003994	25 - 60	540/1000	T-40	3 (BX 45)	147×88×84	230
TRL 1500	1003998	1003040	30 - 60	540/1000	T-40	3 (BX 45)	168×88×84	240
TRL 1700	1003999	1003995	35 - 60	540/1000	T-40	3 (BX 45)	188×88×84	290
TRL 1900	1004000	1003996	35 - 80	540/1000	T-50	3 (BX 45)	207×88×84	310

Nota: specificare se PTO 540 giri/min o PTO 1000 giri/min

Note: Specify PTO speed: 540 rpm or 1000 rpm.

Anmerkung: Bitte angeben, ob die Zapfwelle mit Drehzahl 540 U/min oder 1000 U/min gewünscht ist.

Nota: especificar si la toma de fuerza es de 540 r.p.m. o de 1000 r.p.m.

Note: préciser l'option PDF à 540 tours/min ou à 1000 tours/min.

Di serie	Standard equipment	Serienmässig	Estándar	De série
<ul style="list-style-type: none"> Scatola di trasmissione con doppia ruota libera PTO 1 3/8" Z6 Rotore con sistema di taglio elicoidale Castello fisso Slitte d'appoggio regolabili in altezza Rullo ozioso posteriore regolabile in altezza (114 mm) Scarico posteriore rullo ozioso Protezione posteriore in gomma Protezione anteriore in gomma Protezioni antinfortunistiche conformi alla normativa CE 	<ul style="list-style-type: none"> Gearbox with double freewheel clutch PTO 1 3/8" Z6 Rotor with helical cutting system 3-point linkage fixed Height-adjustable skids Rear levelling roller height adjustable (114 mm) Discharge of the material before the levelling roller Rear protection with rubber Front protection with rubber Protective equipment as per EC safety rules 	<ul style="list-style-type: none"> Getriebe mit doppeltem Freilauf PTO 1 3/8" Z6 Spiralrotor Anbaubock fest Höhenverstellbare Stützkufen Hinterer Stützwalze höhenverstellbar (114 mm) Entladung des Materials vor der Walze Hinterer Gummischutz Frontschutz mit Gummileiste Unfallschutz nach EU-Vorschriften 	<ul style="list-style-type: none"> Caja de engranajes con doble rueda libre TDF 1 3/8" Z6 Rotor con sistema de corte helicoidal Arco de tercer punto fijo Patines de apoyo regulable en altura Rodillo nivelador trasero (114 mm), con regulación en altura Descarga posterior al rodillo nivelador Protección posterior en goma Protección frontal en goma Protecciones de seguridad de acuerdo con la norma CE 	<ul style="list-style-type: none"> Boîtier de transmission avec double roue libre PDF 1 3/8" Z6 Rotor avec système de coupe hélicoïdal Chassis fixe Patins d'appui réglables en hauteur Rouleau d'appui arrière réglable en hauteur (114 mm) Ejection derrière le rouleau d'appui Protection arrière en caoutchouc Protection avant en caoutchouc Protections contre les accidents aux normes CE

TRL	REVERSIBLE MULCHER LIGHT DUTY WITH DISCHARGE BEHIND THE ROLLER
TRL	MULCHGERÄTE FÜR FRONT-UND HECKANBAU LEICHTE AUSFÜHRUNG MIT AUSWURF HINTEN MIT WALZE
TRL	TRITURADORA REVERSIBLE LIGERA CON DESCARGA DETRÁS DEL RODILLO
TRL	BROYEUR RÉVERSIBLE LÉGER AVEC SYSTÈME D'ÉVACUATION À L'ARRIÈRE DU ROULEAU

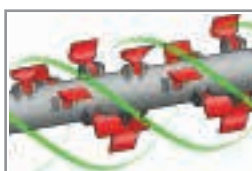
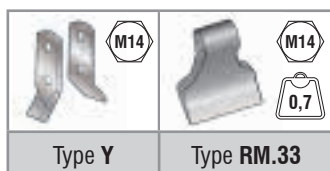
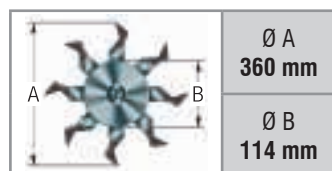

Sistema di taglio elicoidale
Helical cutting system
Spiralrotor
Sistema de corte helicoidal
Système de coupe hélicoïdal



MOD	MOVEMENT MACHINE			
	cm		cm	
TRL 1300	76	71	--	--
TRL 1500	87	81	--	--
TRL 1700	97	91	119	69
TRL 1900	106	101	132	75

WORKING WIDTH	Standard	
	cm	nr
130	36	18
150	44	22
170	48	24
190	56	28

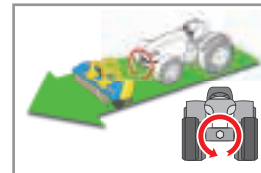

cod.	A richiesta	On request	Auf Anfrage	Opcionales	Sur demande
5130003	Cardano T-40	PTO shaft T-40	Gelenkwelle T-40	Cardán T-40	Cardan T-40
5130005	Cardano T-50	PTO shaft T-50	Gelenkwelle T-50	Cardán T-50	Cardan T-50

cod.	Ricambi	Spare parts	Ersatzteile	Recambios	Pièces de rechange
5354019	Cinghia BX 45	Cug belt BX 45	Keilriemen BX 45	Correa BX 45	Courroie BX 45
5315011	Vite M14 per utensile	M14 screw for tool	M14 Schraube für Werkzeug	Tornillo M14 para herramienta	Vis M14 pour outil
5323016	Dado M14 per utensile	M14 nut for tool	M14 Mutter für Werkzeug	Tuerca M14 para herramienta	Ecrou M14 pour outil
5350047	Mazza RM.33	Hammer RM.33	Hammer RM.33	Martillo RM.33	Marteau RM.33
5350040	Coltello "Y"	"Y" blade	"Y" Messer	Cuchilla "Y"	Couteau "Y"
2020054	Scatola trasmissione (*)	Gear box (*)	Getriebe (*)	Caja de engranajes (*)	Boîtier de transmission (*)
2020154	Scatola trasmissione (**)	Gear box (**)	Getriebe (**)	Caja de engranajes (**)	Boîtier de transmission (**)
2020208	Scatola trasmissione (***)	Gear box (***)	Getriebe (***)	Caja de engranajes (***)	Boîtier de transmission (***)

(*) T310 DRL PR 615 - mod. TRL 1300

(**) T310 DRL PR 780 - mod. TRL 1500

(***) T310 DRL PR 850 - mod. TRL 1700 - TRL 1900

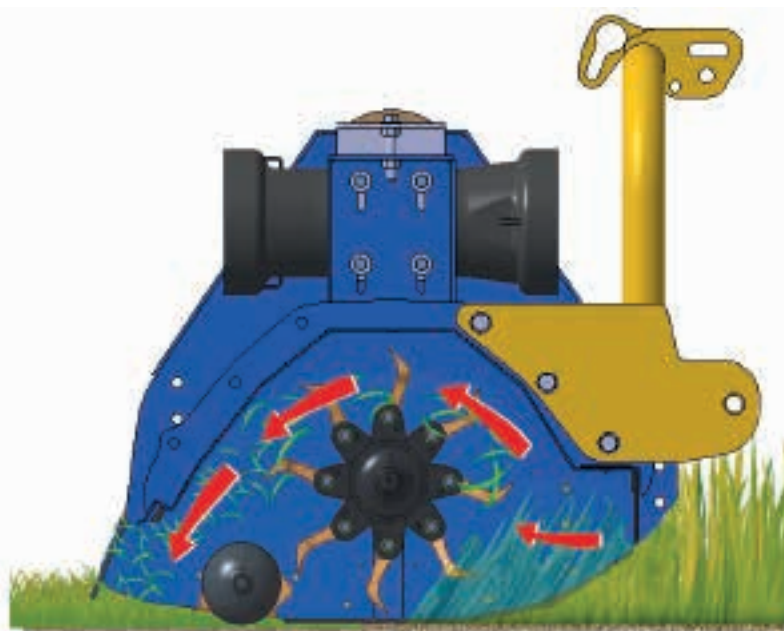

Scarico posteriore al rullo
The cut material is distributed over the top of the roller
Ablage nach der Laufwalze, weniger Kraftbedarf
Descarga detrás del rodillo
Évacuation à l'arrière du rouleau

Impiego	Use	Verwendung	Uso	Utilisation
---------	-----	------------	-----	-------------

La trinciaerba reversibile TFM/R è una macchina studiata per essere applicata a trattori di medio-bassa potenza (30-80 HP), sia frontalmente sia posteriormente. Si presta in modo ottimale per la triturazione di sarmenti, erba, sterpaglie, paglia, e molto altro.

The TFM/R reversible mulcher is designed for front or rear mounting on low to medium power tractors (30 to 80 HP). It is ideal for mulching grass, maize, hay, pruning waste (in olive groves, orchards, etc.), brushwood and more besides.

Das TFM/R Mulchgerät ist für den Front- und Heckanbau an Traktoren mit niedriger bis mittlerer Leistung (30 bis 80 HP) ausgelegt. Es eignet sich ideal zum Mulchen von Gras, Grünfläche, Wiesen, Büsche und Gestrüpp. Das Mulcher TFM/R ist ein kompaktes, aber robustes und zuverlässiges Modell.

La trituradora reversible TFM/R es una máquina diseñada para ser aplicada en la parte delantera o trasera de los tractores de potencia medio baja (30-80 HP). Es excelente para la trituración de hierba, maíz, paja, residuos de poda (en oliveras, frutales, etc.), malezas y mucho más.

Le broyeur d'herbe réversible TFM/R est conçu pour être monté sur des tracteurs de moyenne-basse puissance (30-80 HP), aussi bien à l'avant qu'à l'arrière. Il est particulièrement indiqué pour le broyage d'herbe, maïs, paille, déchets d'élagage (dans les oliveraies, les vergers, etc.), de broussailles et autres végétaux.

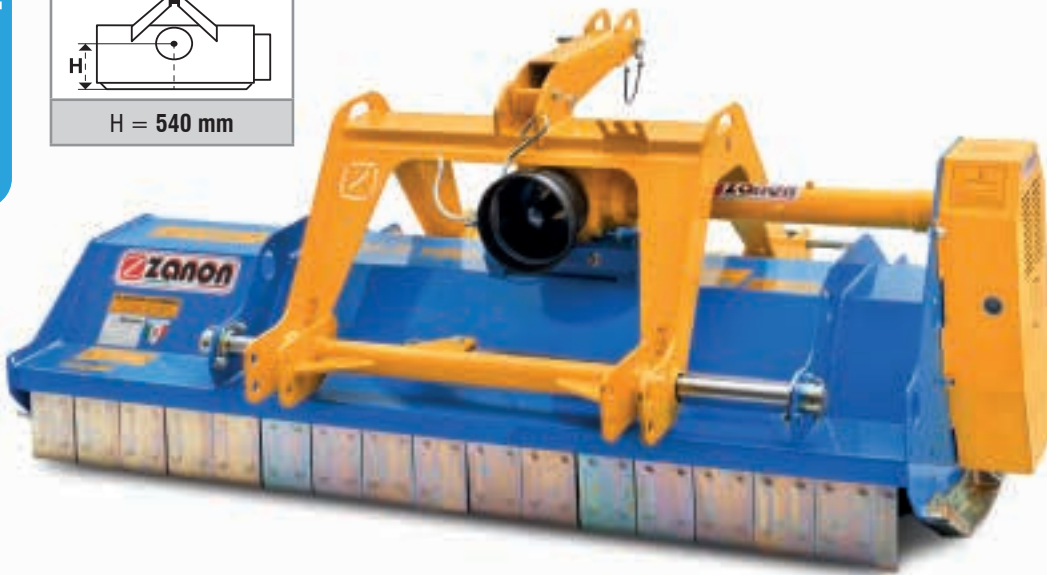
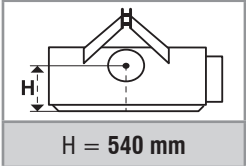

Scarico posteriore al rullo
The cut material is distributed over the top of the roller
Ablage nach der Laufwalze, weniger Kraftbedarf
Descarga detrás del rodillo
Évacuation à l'arrière du rouleau



mod.	cod.	cod.	HP	rpm/min	type	nr (type)	cm	kg
TFM/R 1300	1002905	1002901	30 - 60	540/1000	T-40	3 (BX 45)	150×100×80	340
TFM/R 1500	1002906	1002902	35 - 60	540/1000	T-40	3 (BX 45)	170×100×80	350
TFM/R 1700	1002907	1002903	40 - 60	540/1000	T-40	3 (BX 45)	190×100×80	400
TFM/R 1900	1002908	1002904	40 - 80	540/1000	T-50	3 (BX 45)	210×100×80	430

Nota: specificare se PTO 540 giri/min o PTO 1000 giri/min

Note: Specify PTO speed: 540 rpm or 1000 rpm.

Anmerkung: Bitte angeben, ob die Zapfwelle mit Drehzahl 540 U/min oder 1000 U/min gewünscht ist.

Nota: especificar si la toma de fuerza es de 540 r.p.m. o de 1000 r.p.m.

Note: préciser l'option PDF à 540 tours/min ou à 1000 tours/min.

Di serie	Standard equipment	Serienmässig	Estándar	De série
<ul style="list-style-type: none"> Scatola di trasmissione con doppia ruota libera PTO 1 3/8" Z6 Rotore con sistema di taglio elicoidale Spostamento su barre cromate Spostamento laterale meccanico Angolare rompitore Slitte d'appoggio regolabili in altezza Rullo ozioso posteriore regolabile in altezza (114 mm) Scarico posteriore rullo ozioso Protezione posteriore in gomma Protezione anteriore a bandinelle Protezioni antinfortunistiche conformi alla normativa CE 	<ul style="list-style-type: none"> Gearbox with double freewheel clutch PTO 1 3/8" Z6 Rotor with helical cutting system Side shift on chrome bars Mechanical side shift Corner reinforcement for shredding material Height-adjustable skids Rear levelling roller height adjustable (114 mm) Discharge of the material before the levelling roller Rear protection with rubber Front protection with metal flaps Protective equipment as per EC safety rules 	<ul style="list-style-type: none"> Getriebe mit doppeltem Freilauf PTO 1 3/8" Z6 Spiralrotor Seitenverschiebung über Chromstangen Mechanische Seitenverschiebung Eckenverstärkung für Zerkleinerungsmaterial Höhenverstellbare Stützkufen Hintere Stützwalze höhenverstellbar (114 mm) Entladung des Materials vor der Walze Hinterer Gummischutz Frontschutz mit Metallklappen Unfallschutz nach EU-Vorschriften 	<ul style="list-style-type: none"> Caja de engranajes con doble rueda libre TDF 1 3/8" Z6 Rotor con sistema de corte helicoidal Desplazamiento sobre tubo cromado Desplazamiento lateral mecánico Rompedor angular Patines de apoyo regulable en altura Rodillo nivelador trasero (114 mm), con regulación en altura Descarga posterior al rodillo nivelador Protección posterior en goma Protección delantera mediante placas metálicas Protecciones de seguridad de acuerdo con la norma CE 	<ul style="list-style-type: none"> Boîtier de transmission avec double roue libre PDF 1 3/8" Z6 Rotor avec système de coupe hélicoïdal Déplacement avec barre chromée Déport latéral mécanique Barre brisante Patins d'appui réglables en hauteur Rouleau d'appui arrière réglable en hauteur (114 mm) Ejection derrière le rouleau d'appui Protection arrière en caoutchouc Protection avant avec volets métalliques Protections contre les accidents aux normes CE

TFM/R	REVERSIBLE MULCHER LIGHT DUTY WITH DISCHARGE BEHIND THE ROLLER
TFM/R	MULCHGERÄTE FÜR FRONT-UND HECKANBAU LEICHTE AUSFÜHRUNG MIT AUSWURF HINTEN MIT WALZE
TFM/R	TRITURADORA REVERSIBLE LIGERA CON DESCARGA DETRÁS DEL RODILLO
TFM/R	BROYEUR RÉVERSIBLE LÉGER AVEC SYSTÈME D'ÉVACUATION À L'ARRIÈRE DU ROULEAU



ORIGINAL MADE IN ITALY

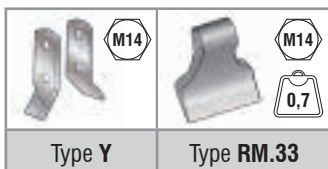
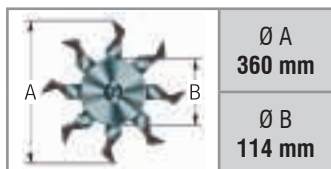

Sistema di taglio elicoidale
Helical cutting system
Spiralrotor
Sistema de corte helicoidal
Système de coupe hélicoïdal

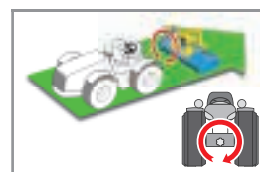
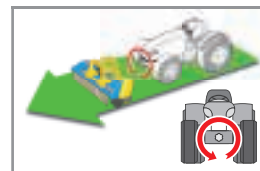

TFM/R

MOD	MOVEMENT MACHINE				WORKING WIDTH	Standard		
	cm		cm			cm	nr	nr
TFM/R 1300	90	60	60	90	30	130	36	18
TFM/R 1500	90	80	60	110	30	150	44	22
TFM/R 1700	90	100	60	130	30	170	48	24
TFM/R 1900	110	100	90	130	30	190	56	28

cod.	A richiesta	On request	Auf Anfrage	Opcionales	Sur demande
5130003	Cardano T-40	PTO shaft T-40	Gelenkwelle T-40	Cardán T-40	Cardan T-40
5130005	Cardano T-50	PTO shaft T-50	Gelenkwelle T-50	Cardán T-50	Cardan T-50
2050010	Gruppo spost. idr. 30 cm	Hydraulic side shift 30 cm	Hydraulische Verschiebung 30 cm	Kit desplazador hidr. 30 cm	Groupe de dépl. lat. 30 cm

cod.	Ricambi	Spare parts	Ersatzteile	Recambios	Pièces de rechange
5354019	Cinghia BX 45	Cug belt BX 45	Keilriemen BX 45	Correa BX 45	Courroie BX 45
5315011	Vite M14 per utensile	M14 screw for tool	M14 Schraube für Werkzeug	Tornillo M14 para herramienta	Vis M14 pour outil
5323016	Dado M14 per utensile	M14 nut for tool	M14 Mutter für Werkzeug	Tuerca M14 para herramienta	Ecrou M14 pour outil
5350047	Mazza RM.33	Hammer RM.33	Hammer RM.33	Martillo RM.33	Marteau RM.33
5350040	Coltello "Y"	"Y" blade	"Y" Messer	Cuchilla "Y"	Couteau "Y"
2020054	Scatola trasmissione (*)	Gear box (*)	Getriebe (*)	Caja de engranajes (*)	Boîtier de transmission (*)
2020154	Scatola trasmissione (**)	Gear box (**)	Getriebe (**)	Caja de engranajes (**)	Boîtier de transmission (**)

(*) mod. 1300/1500/1700, (**) mod. 1900



Impiego	Use	Verwendung	Uso	Utilisation
---------	-----	------------	-----	-------------

La trinciaerba reversibile media TRV-PRO si presta in modo ottimale per la triturazione di sarmenti, mais, erba, sterpaglie, paglia, e molto altro.

The TRV-PRO reversible mulcher medium duty is ideal for mulching twigs, grass, brushwood, hay and more besides.

Das neue Mulchgerät TRV-PRO ist für den Front- und Heckanbau ausgelegt. Die Maschine ist ideal zum Mulchen von Zweigen, Gras, Reisig, Heu und mehr.

La trituradora de hierba reversible media TRV-PRO es excelente para triturar sarmentos, hierba, malezas, paja y mucho más.

Le broyeur d'herbe réversible moyen TRV-PRO est particulièrement indiqué pour le broyage de sarments, herbe, broussailles, paille et de nombreux autres végétaux.

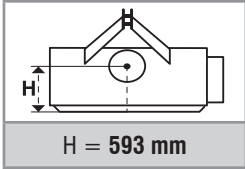

mod.	cod.	cod.	HP	rpm/min	type	nr (type)	cm	kg
TRV-PRO 1600	1002956	1002960	40 - 70	540/1000	T-40	3 (XPB 1250)	181×110×93	445
TRV-PRO 1900	1002957	1002961	50 - 70	540/1000	T-50	4 (XPB 1250)	211×110×93	525
TRV-PRO 2250	1002958	1002962	70 - 100	540/1000	T-50	5 (XPB 1250)	241×110×93	590
TRV-PRO 2500	1002959	1002963	70 - 100	540/1000	T-60	5 (XPB 1250)	271×110×93	650

Nota: specificare se PTO 540 giri/min o PTO 1000 giri/min

Note: Specify PTO speed: 540 rpm or 1000 rpm.

Anmerkung: Bitte angeben, ob die Zapfwelle mit Drehzahl 540 U/min oder 1000 U/min gewünscht ist.

Nota: especificar si la toma de fuerza es de 540 r.p.m. o de 1000 r.p.m.

Note: préciser l'option PDF à 540 tours/min ou à 1000 tours/min.

Di serie	Standard equipment	Serienmässig	Estándar	De série
<ul style="list-style-type: none"> Scatola di trasmissione con doppia ruota libera PTO 1 3/8" Z6 Rotore con sistema di taglio lineare Spostamento su barre cromate Spostamento laterale meccanico Angolare rompitore Slitte d'appoggio regolabili in altezza Rullo ozioso posteriore regolabile in altezza (140 mm) Raschifango per pulizia rullo ozioso Scarico anteriore rullo ozioso Protezione posteriore in gomma Protezione anteriore a bandinelle Protezioni antinfortunistiche conformi alla normativa CE 	<ul style="list-style-type: none"> Gearbox with double freewheel clutch PTO 1 3/8" Z6 Rotor with linear cutting system Side shift on chrome bars Mechanical side shift Corner reinforcement for shredding material Height-adjustable skids Rear levelling roller height adjustable (140 mm) Scraper for rear levelling roller Discharge of the material over the levelling roller Rear protection with rubber Front protection with metal flaps Protective equipment as per EC safety rules 	<ul style="list-style-type: none"> Getriebe mit doppeltem Freilauf PTO 1 3/8" Z6 Rotor mit linear Schnittsystem Seitenverschiebung über Chromstangen Mechanische Seitenverschiebung Eckenverstärkung für Zerkleinerungsmaterial Höhenverstellbare Stützkufen Hintere Stützwalze höhenverstellbar (140 mm) Walzenabstreifer Entladung des Materials über die Walze Hinterer Gummischutz Frontschutz mit Metallklappen Unfallschutz nach EU-Vorschriften 	<ul style="list-style-type: none"> Caja de engranajes con doble rueda libre TDF 1 3/8" Z6 Rotor con sistema de corte lineal Desplazamiento sobre tubo cromado Desplazamiento lateral mecánico Rompedor angular Patines de apoyo regulable en altura Rodillo nivelador trasero (140 mm), con regulación en altura Limpiador montado en el rodillo nivelador trasero Descarga anterior al rodillo nivelador Protección posterior en goma Protección delantera mediante placas metálicas Protecciones de seguridad de acuerdo con la norma CE 	<ul style="list-style-type: none"> Boîtier de transmission avec double roue libre PDF 1 3/8" Z6 Rotor avec système de coupe linéaire Déplacement avec barre chromée Déport latéral mécanique Barre brisante Patins d'appui réglables en hauteur Rouleau d'appui arrière réglable en hauteur (140 mm) Racleur pour le rouleau d'appui Ejection devant le rouleau d'appui Protection arrière en caoutchouc Protection avant avec volets métalliques Protections contre les accidents aux normes CE

TRV-PRO	REVERSIBLE MULCHER MEDIUM DUTY
TRV-PRO	MULCHGERÄTE FÜR FRONT-UND HECKANBAU MITTELSCHWERE AUSFÜHRUNG
TRV-PRO	TRITURADORA REVERSIBLE MEDIA
TRV-PRO	BROYEUR RÉVERSIBLE MOYEN

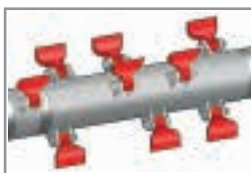
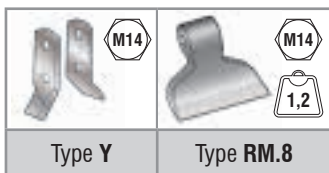
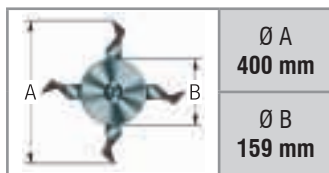

Sistema di taglio lineare
Linear cutting system
Linearroter
Sistema de corte lineal
Système de coupe linéaire



MOD	MOVEMENT MACHINE				WORKING WIDTH	Standard	
	cm	cm	cm	cm		nr	nr
TRV-PRO 1600	110	71	70	111	40	40	20
TRV-PRO 1900	110	101	70	141	40	48	24
TRV-PRO 2250	125	116	85	156	40	56	28
TRV-PRO 2500	135	136	95	136	40	64	32

MOD	cm	nr	nr
TRV-PRO 1600	110	71	70
TRV-PRO 1900	110	101	70
TRV-PRO 2250	125	116	85
TRV-PRO 2500	135	136	95

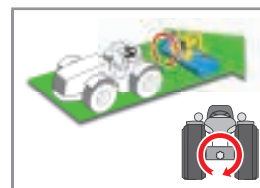
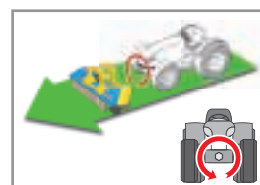

cod.	A richiesta	On request	Auf Anfrage	Opcionales	Sur demande
5130003	Cardano T-40	PTO shaft T-40	Gelenkwelle T-40	Cardán T-40	Cardan T-40
5130005	Cardano T-50	PTO shaft T-50	Gelenkwelle T-50	Cardán T-50	Cardan T-50
5130009	Cardano T-60	PTO shaft T-60	Gelenkwelle T-60	Cardán T-60	Cardan T-60
2050011	Gruppo spost. idr. 40 cm	Hydraulic side shift 40 cm	Hydraulische Verschiebung 40 cm	Kit desplazador hidr. 40 cm	Groupe de dépl. lat. 40 cm
2050733	Kit secondo arco con attacco a tre punti	Second 3-point linkage	Zweiter Dreipunkbock	Kit arco de tercer punto posterior	Kit deuxième arc d'attelage 3 points
2050046	Kit ruote in gomma pivotanti	Pivoting rubber wheels kit	Satz schwenkbare Gummiräder	Kit de ruedas en goma, pivotantes	Kit roues pivotantes en caoutchouc

cod.	Ricambi	Spare parts	Ersatzteile	Recambios	Pièces de rechange
5354003	Cinghia SPB-1250	Cug belt SPB-1250	Keilriemen SPB-1250	Correa SPB-1250	Courroie SPB-1250
5315011	Vite M14 per utensile	M14 screw for tool	M14 Schraube für Werkzeug	Tornillo M14 para herramienta	Vis M14 pour outil
5323016	Dado M14 per utensile	M14 nut for tool	M14 Mutter für Werkzeug	Tuerca M14 para herramienta	Ecrou M14 pour outil
5350024	Mazza RM.8	Hammer RM.8	Hammer RM.8	Martillo RM.8	Marteau RM.8
5350040	Coltello "Y"	"Y" blade	"Y" Messer	Cuchilla "Y"	Couteau "Y"
2020039	Scatola tras. Mod. 1600-1900	Gear box Mod. 1600-1900	Getriebe Mod. 1600-1900	Caja de eng. Mod. 1600-1900	Boîtier de transm. Mod. 1600-1900
2020094	Scatola tras. Mod. 2250-2500	Gear box Mod. 2250-2500	Getriebe Mod. 2250-2500	Caja de eng. Mod. 2250-2500	Boîtier de transm. Mod. 2250-2500

cod. 2050733

On request

Kit secondo arco con attacco a tre punti
Second 3-point linkage
Zweiter Dreipunkbock
Kit arco de tercer punto posterior
Kit deuxième arc d'attelage 3 points

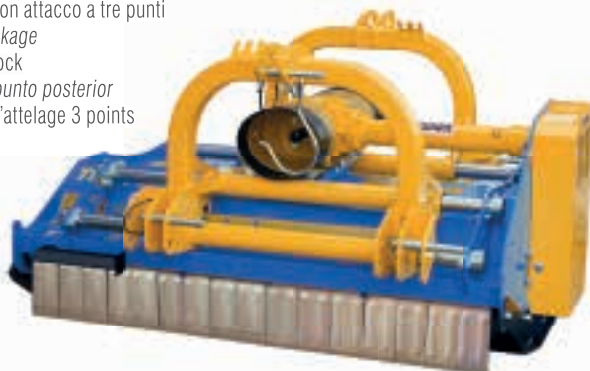

cod. 2050046

On request

Kit ruote in gomma pivotanti
Pivoting rubber wheels kit
Satz schwenkbare Gummiräder
Kit de ruedas en goma, pivotantes
Kit roues pivotantes en caoutchouc



Impiego

La trinciaerba reversibile TRG è una macchina studiata per essere applicata a trattori di medio-bassa potenza, sia frontalmente sia posteriormente. Si presta in modo ottimale per la triturazione di erba, mais, paglia, residui di potatura (in uliveti, frutteti, ecc.), sterpaglie e molto altro.

Use

The TRG reversible mulcher is designed for front or rear mounting on low to medium power tractors. It is ideal for mulching grass, maize, hay, pruning waste (in olive groves, orchards, etc.), brushwood and more besides.

Verwendung

Das TRG Mulchgerät ist für den Front- und Heckanbau an Traktoren mit mittlerer Leistungstärke ausgelegt. Es eignet sich optimal zum Häckseln von Gras, Mais, Stroh, Baumschnitt (Obstplantagen, Weinberge usw.), Gestrüpp und vieles andere mehr.

Uso

La trituradora reversible TRG es una máquina diseñada para ser aplicada en la parte delantera o trasera de los tractores de potencia medio baja. Es excelente para la trituración de hierba, maíz, paja, residuos de poda (en olivares, frutales, etc.), malezas y mucho más.

Utilisation

Le broyeur d'herbe réversible TRG est conçu pour être monté sur des tracteurs de moyenne-basse puissance, aussi bien à l'avant qu'à l'arrière. Il est particulièrement indiqué pour le broyage d'herbe, maïs, paille, déchets d'élagage (dans les oliveraies, les vergers, etc.), de broussailles et autres végétaux.

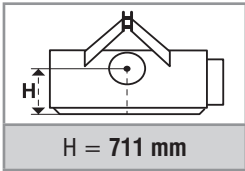

mod.	cod.	cod.	HP	rpm/min	type	nr (type)	cm	kg
TRG 1000	1002631	1002630	30 - 60	540/1000	T-40	2 (XPB 1600)	120×110×110	470
TRG 1200	1002633	1002632	30 - 60	540/1000	T-40	2 (XPB 1600)	140×110×110	525
TRG 1400	1002635	1002634	35 - 60	540/1000	T-40	3 (XPB 1600)	160×110×110	550
TRG 1600	1002637	1002636	40 - 90	540/1000	T-50	3 (XPB 1600)	175×110×110	635
TRG 1800	1002639	1002638	50 - 90	540/1000	T-50	4 (XPB 1600)	195×110×110	675
TRG 2000	1002641	1002640	50 - 90	540/1000	T-50	4 (XPB 1600)	215×110×110	720
TRG 2200	1002643	1002642	60 - 90	540/1000	T-50	5 (XPB 1600)	235×110×110	780

Nota: specificare se PTO 540 giri/min o PTO 1000 giri/min

Note: Specify PTO speed: 540 rpm or 1000 rpm.

Anmerkung: Bitte angeben, ob die Zapfwelle mit Drehzahl 540 U/min oder 1000 U/min gewünscht ist.

Nota: especificar si la toma de fuerza es de 540 r.p.m. o de 1000 r.p.m.

Note: préciser l'option PDF à 540 tours/min ou à 1000 tours/min.

Di serie	Standard equipment	Serienmässig	Estándar	De série
<ul style="list-style-type: none"> Scatola di trasmissione con doppia ruota libera PTO 1 3/8" Z6 Rotore con sistema di taglio elicoidale Spostamento su barre cromate Spostamento laterale meccanico Doppia fila di pettini rompitori Slitte d'appoggio regolabili in altezza Rullo ozioso posteriore regolabile in altezza (194 mm) Raschifango per pulizia rullo ozioso Scarico anteriore rullo ozioso Protezione anteriore a bandinelle Protezioni antinfortunistiche conformi alla normativa CE 	<ul style="list-style-type: none"> Gearbox with double freewheel clutch PTO 1 3/8" Z6 Rotor with helical cutting system Side shift on chrome bars Mechanical side shift Double row counter-blades Height-adjustable skids Rear levelling roller height adjustable (194 mm) Scraper for rear levelling roller Discharge of the material over the levelling roller Front protection with metal flaps Protective equipment as per EC safety rules 	<ul style="list-style-type: none"> Getriebe mit doppeltem Freilauf PTO 1 3/8" Z6 Spiralrotor Seitenverschiebung über Chromstangen Mechanische Seitenverschiebung 2 Reihen Gegenschneide Höhenverstellbare Stützkufen Hintere Stützwalze höhenverstellbar (194 mm) Walzenabstreifer Entladung des Materials über die Walze Frontschutz mit Metallklappen Unfallschutz nach EU-Vorschriften 	<ul style="list-style-type: none"> Caja de engranajes con doble rueda libre TDF 1 3/8" Z6 Rotor con sistema de corte helicoidal Desplazamiento sobre tubo cromado Desplazamiento lateral mecánico Doble fila de rompedores Patines de apoyo regulable en altura Rodillo nivelador trasero (194 mm), con regulación en altura Limpiador montado en el rodillo nivelador trasero Descarga anterior al rodillo nivelador Protección delantera mediante placas metálicas Protecciones de seguridad de acuerdo con la norma CE 	<ul style="list-style-type: none"> Boîtier de transmission avec double roue libre PDF 1 3/8" Z6 Rotor avec système de coupe hélicoïdal Déplacement avec barre chromée Déport latéral mécanique Double rangée de peignes Patins d'appui réglables en hauteur Rouleau d'appui arrière réglable en hauteur (194 mm) Racleur pour le rouleau d'appui Ejection devant le rouleau d'appui Protection avant avec volets métalliques Protections contre les accidents aux normes CE

TRG	REVERSIBLE MULCHER MEDIUM DUTY
TRG	MULCHGERÄTE FÜR FRONT-UND HECKANBAU MITTELSCHWERE AUSFÜHRUNG
TRG	TRITURADORA REVERSIBLE MEDIA
TRG	BROYEUR RÉVERSIBLE MOYEN

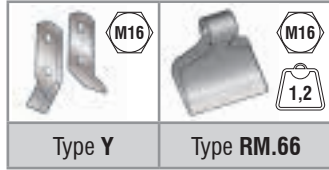
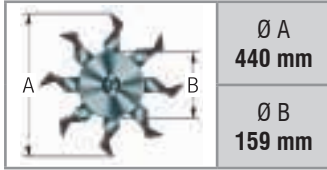

Sistema di taglio elicoidale
Helical cutting system
Spiral rotor
Sistema de corte helicoidal
Système de coupe hélicoïdal



MOD	MOVEMENT MACHINE				
mod.	cm	cm	cm	cm	cm
TRG 1000	48	72	78	42	30
TRG 1200	48	92	78	62	30
TRG 1400	48	112	78	82	30
TRG 1600	55	120	95	80	40
TRG 1800	55	140	95	100	40
TRG 2000	67	148	107	108	40
TRG 2200	92	143	132	103	40

WORKING WIDTH	Standard	
cm	nr	nr
100	24	12
120	32	16
140	36	18
160	40	20
180	48	24
200	58	24
220	56	28

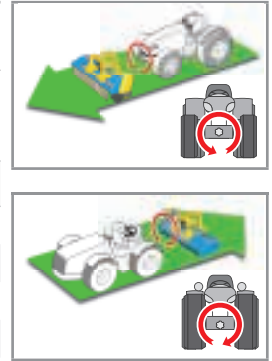

cod.	A richiesta	On request	Auf Anfrage	Opcionales	Sur demande
5130003	Cardano T-40	PTO shaft T-40	Gelenkwelle T-40	Cardán T-40	Cardan T-40
5130005	Cardano T-50	PTO shaft T-50	Gelenkwelle T-50	Cardán T-50	Cardan T-50
2050010	Gruppo spost. idr. 30 cm	Hydraulic side shift 30 cm	Hydraulische Verschiebung 30 cm	Kit desplazador hidr. 30 cm	Groupe de dépl. lat. 30 cm
2050011	Gruppo spost. idr. 40 cm	Hydraulic side shift 40 cm	Hydraulische Verschiebung 40 cm	Kit desplazador hidr. 40 cm	Groupe de dépl. lat. 40 cm
2050264	Kit ruote in gomma pivottanti	Pivoting rubber wheels kit	Satz schwenkbare Gummiräder	Kit de ruedas en goma, pivotantes	Kit roues pivotantes en caoutchouc
5227908	Lam. antiusura TRG 1000 *	Wear plate TRG 1000 *	Verschleißplatten TRG 1000 *	Placa anti desgaste TRG 1000 *	Plaque anti-usure TRG 1000 *
5227909	Lam. antiusura TRG 1200 *	Wear plate TRG 1200 *	Verschleißplatten TRG 1200 *	Placa anti desgaste TRG 1200 *	Plaque anti-usure TRG 1200 *
5227910	Lam. antiusura TRG 1400 *	Wear plate TRG 1400 *	Verschleißplatten TRG 1400 *	Placa anti desgaste TRG 1400 *	Plaque anti-usure TRG 1400 *
5227911	Lam. antiusura TRG 1600 *	Wear plate TRG 1600 *	Verschleißplatten TRG 1600 *	Placa anti desgaste TRG 1600 *	Plaque anti-usure TRG 1600 *
5227912	Lam. antiusura TRG 1800 *	Wear plate TRG 1800 *	Verschleißplatten TRG 1800 *	Placa anti desgaste TRG 1800 *	Plaque anti-usure TRG 1800 *
5227913	Lam. antiusura TRG 2000 *	Wear plate TRG 2000 *	Verschleißplatten TRG 2000 *	Placa anti desgaste TRG 2000 *	Plaque anti-usure TRG 2000 *
5227914	Lam. antiusura TRG 2200 *	Wear plate TRG 2200 *	Verschleißplatten TRG 2200 *	Placa anti desgaste TRG 2200 *	Plaque anti-usure TRG 2200 *

(*) per questo modello sono necessarie 2 lamiere antiusura

(*) 2 wear plates are required for this model

(*) Für dieses Modell werden 2 Verschleißplatten benötigt

(*) Se requieren 2 placas anti desgaste para este modelo

(*) 2 plaque anti-usure sont nécessaires pour ce modèle

cod.	Ricambi	Spare parts	Ersatzteile	Recambios	Pièces de rechange
5354067	Cinghia XPB-1600	Cug belt XPB-1600	Keilriemen XPB-1600	Correa XPB-1600	Courroie XPB-1600
5315446	Vite M16 per utensile	M16 screw for tool	M16 Schraube für Werkzeug	Tornillo M16 para herramienta	Vis M16 pour outil
5323017	Dado M16 per utensile	M16 nut for tool	M16 Mutter für Werkzeug	Tuerca M16 para herramienta	Ecrou M16 pour outil
5350121	Mazza RM.66	Hammer RM.66	Hammer RM.66	Martillo RM.66	Marteau RM.66
5350127	Coltello "Y"	"Y" blade	"Y" Messer	Cuchilla "Y"	Couteau "Y"
2020012	Scatola trasm. TRG 1000/1400	Gear box TRG 1000/1400	Getriebe TRG 1000/1400	Caja de engran. TRG 1000/1400	Boîtier de transm. TRG 1000/1400
2020038	Scatola trasm. TRG 1600/1800	Gear box TRG 1600/1800	Getriebe TRG 1600/1800	Caja de engran. TRG 1600/1800	Boîtier de transm. TRG 1600/1800
2020039	Scatola trasmissione TRG 2000	Gear box TRG 2000	Getriebe TRG 2000	Caja de engranajes TRG 2000	Boîtier de transm. TRG 2000
2020094	Scatola trasmissione TRG 2200	Gear box TRG 2200	Getriebe TRG 2200	Caja de engranajes TRG 2200	Boîtier de transm. TRG 2200

cod. 2050264
On request

Kit ruote in gomma pivottanti
Pivoting rubber wheels kit
Satz schwenkbare Gummiräder
Kit de ruedas en goma, pivotantes
Kit roues pivotantes en caoutchouc



Impiego Use Verwendung Uso Utilisation

La trinciaerba reversibile RFG è una macchina studiata per essere applicata a trattori di medio-alta potenza, sia frontalmente sia posteriormente. Si presta in modo ottimale per la triturazione di erba, mais, paglia, residui di potatura (in uliveti, frutteti, ecc.), sterpaglie e molto altro.

The RFG reversible mulcher is designed for front or rear mounting on medium to high power tractors. It is ideal for mulching grass, maize, hay, pruning waste (in olive groves, orchards, etc.), brushwood and more besides.

Das RFG Mulchgerät ist für den Front- und Heckanbau an Traktoren mit mittlerer und hoher Leistungstärke ausgelegt. RFG ist ein vielseitiges Gerät für die Zerkleinerung von Stroh und Maisstroh sowie für die Pflege von Wiesen und Brachland.

La trituradora reversible RFG es una máquina diseñada para ser aplicada en la parte delantera o trasera de los tractores de potencia medio-alta. Es excelente para la trituración de hierba, maíz, paja, residuos de poda (en olivares, frutales, etc.), alezas y mucho más.

Le broyeur d'herbe réversible RFG est conçu pour être monté sur des tracteurs de moyenne-haute puissance, aussi bien à l'avant qu'à l'arrière. Il est particulièrement indiqué pour le broyage d'herbe, maïs, paille, déchets d'élagage (dans les oliveraies, les vergers, etc.), de broussailles et autres végétaux.

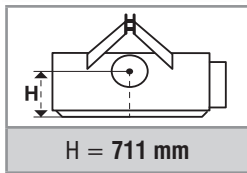

mod.	cod.	cod.	HP	rpm/min	type	nr (type)	cm	kg
RFG 2400	1002595	1002599	70 - 130	540/1000	T-60	5 (XPB 1600)	262×115×110	905
RFG 2600	1002596	1002600	70 - 130	540/1000	T-70	6 (XPB 1600)	282×115×110	935
RFG 2800	1002597	1002601	80 - 130	540/1000	T-70	6 (XPB 1600)	300×115×110	990
RFG 3000	1002598	1002602	90 - 130	540/1000	T-70	6 (XPB 1600)	319×115×110	1025

Nota: specificare se PTO 540 giri/min o PTO 1000 giri/min

Note: Specify PTO speed: 540 rpm or 1000 rpm.

Anmerkung: Bitte angeben, ob die Zapfwelle mit Drehzahl 540 U/min oder 1000 U/min gewünscht ist.

Nota: especificar si la toma de fuerza es de 540 r.p.m. o de 1000 r.p.m.

Note: préciser l'option PDF à 540 tours/min ou à 1000 tours/min.

Di serie	Standard equipment	Serienmässig	Estándar	De série
<ul style="list-style-type: none"> Scatola di trasmissione con doppia ruota libera PTO 1 3/8" Z6 Rotore con sistema di taglio elicoidale Spostamento su barre cromate Spostamento laterale meccanico Doppia fila di pettini rompitori Slitte d'appoggio regolabili in altezza Rullo ozioso posteriore regolabile in altezza (194 mm) Raschiafango per pulizia rullo ozioso Scarico anteriore rullo ozioso Protezione anteriore a bandinelle Protezioni antinfortunistiche conformi alla normativa CE 	<ul style="list-style-type: none"> Gearbox with double freewheel clutch PTO 1 3/8" Z6 Rotor with helical cutting system Side shift on chrome bars Mechanical side shift Double row counter-blades Height-adjustable skids Rear levelling roller height adjustable (194 mm) Scraper for rear levelling roller Discharge of the material over the levelling roller Front protection with metal flaps Protective equipment as per EC safety rules 	<ul style="list-style-type: none"> Getriebe mit doppeltem Freilauf PTO 1 3/8" Z6 Spiralrotor Seitenverschiebung über Chromstangen Mechanische Seitenverschiebung 2 Reihen Gegenschneide Höhenverstellbare Stützkufen Hintere Stützwalze höhenverstellbar (194 mm) Walzenabstreifer Entladung des Materials über die Walze Frontschutz mit Metallklappen Unfallschutz nach EU-Vorschriften 	<ul style="list-style-type: none"> Caja de engranajes con doble rueda libre TDF 1 3/8" Z6 Rotor con sistema de corte helicoidal Desplazamiento sobre tubo cromado Desplazamiento lateral mecánico Doble fila de rompedores Patines de apoyo regulable en altura Rodillo nivelador trasero (194 mm), con regulación en altura Limpiador montado en el rodillo nivelador trasero Descarga anterior al rodillo nivelador Protección delantera mediante placas metálicas Protecciones de seguridad de acuerdo con la norma CE 	<ul style="list-style-type: none"> Boîtier de transmission avec double roue libre PDF 1 3/8" Z6 Rotor avec système de coupe hélicoïdal Déplacement avec barre chromée Déport latéral mécanique Double rangée de peignes Patins d'appui réglables en hauteur Rouleau d'appui arrière réglable en hauteur (194 mm) Racleur pour le rouleau d'appui Ejection devant le rouleau d'appui Protection avant avec volets métalliques Protections contre les accidents aux normes CE

RFG	REVERSIBLE MULCHER MEDIUM DUTY
RFG	MULCHGERÄTE FÜR FRONT-UND HECKANBAU MITTELSCHWERE AUSFÜHRUNG
RFG	TRITURADORA REVERSIBLE MEDIA
RFG	BROYEUR RÉVERSIBLE MOYEN



ORIGINAL MADE IN ITALY

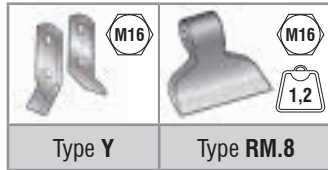
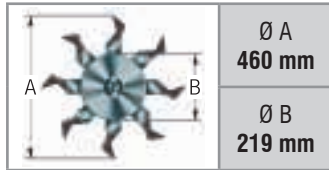

Sistema di taglio elicoidale
Helical cutting system
Spiralrotor
Sistema de corte helicoidal
Système de coupe hélicoïdal



MOD	MOVEMENT MACHINE			
	cm	cm	cm	cm
RFG 2400	132	130	92	170
RFG 2600	157	125	117	165
RFG 2800	157	143	117	183
RFG 3000	172	147	132	187

WORKING WIDTH	Standard	
	cm	nr
240	64	32
260	64	32
280	72	36
300	80	40

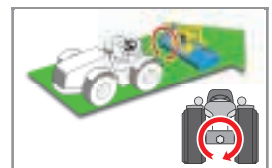
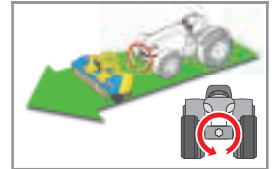

cod.	A richiesta	On request	Auf Anfrage	Opcionales	Sur demande
5130009	Cardano T-60	PTO shaft T-60	Gelenkwelle T-60	Cardán T-60	Cardan T-60
5130010	Cardano T-70	PTO shaft T-70	Gelenkwelle T-70	Cardán T-70	Cardan T-70
2050011	Gruppo spost. idr. 40 cm	Hydraulic side shift 40 cm	Hydraulische Verschiebung 40 cm	Kit desplazador hidr. 40 cm	Groupe de dépl. lat. 40 cm
2050264	Kit ruote in gomma pivotanti	Pivoting rubber wheels kit	Satz schwenkbare Gummiräder	Kit de ruedas en goma, pivotantes	Kit roues pivotantes en caoutchouc
5227915	Lam. antiusura anteriore e posteriore RFG 2400 *	Wear plate front and rear attachment RFG 2400 *	Verschleißplatten für Frontgehäuse und Heckgehäuse RFG 2400 *	Placa anti desgaste delantera y trasera RFG 2400 *	Plaque avant et arrière anti-usure RFG 2400 *
5227916	Lam. antiusura RFG 2600 *	Wear plate RFG 2600 *	Verschleißplatten RFG 2600 *	Placa anti desgaste RFG 2600 *	Plaque anti-usure RFG 2600 *
5227917	Lam. antiusura RFG 2800 *	Wear plate RFG 2800 *	Verschleißplatten RFG 2800 *	Placa anti desgaste RFG 2800 *	Plaque anti-usure RFG 2800 *
5227918	Lam. antiusura RFG 3000 *	Wear plate RFG 3000 *	Verschleißplatten RFG 3000 *	Placa anti desgaste RFG 3000 *	Plaque anti-usure RFG 3000 *
2050831	Kit ingombro anteriore	Front overall dimensions kit	Kit Front-Warntafeln	Dispositivos dim. máx. delanteras	Kit éclairage et signalisation avant
2050832	Kit ingombro posteriore	Rear overall dimensions kit	Kit Heck-Warntafeln	Dispositivos dim. máx. traseras	Kit éclairage et signalisation arrière

(*) per questo modello sono necessarie 2 lamiere antiusura

(*) 2 wear plates are required for this model

(*) Für dieses Modell werden 2 Verschleißplatten benötigt

(*) Se requieren 2 placas anti desgaste para este modelo

(*) 2 plaque anti-usure sont nécessaires pour ce modèle

cod.	Ricambi	Spare parts	Ersatzteile	Recambios	Pièces de rechange
5354067	Cinghia XPB-1600	Cug belt XPB-1600	Keilriemen XPB-1600	Correa XPB-1600	Courroie XPB-1600
5315446	Vite M16 per utensile	M16 screw for tool	M16 Schraube für Werkzeug	Tornillo M16 para herramienta	Vis M16 pour outil
5323017	Dado M16 per utensile	M16 nut for tool	M16 Mutter für Werkzeug	Tuerca M16 para herramienta	Ecrou M16 pour outil
5350128	Mazza RM.8	Hammer RM.8	Hammer RM.8	Martillo RM.8	Marteau RM.8
5350127	Coltello "Y"	"Y" blade	"Y" Messer	Cuchilla "Y"	Couteau "Y"
2020042	Scatola trasmissione RFG 2400	Gear box RFG 2400	Getriebe RFG 2400	Caja de engranajes RFG 2400	Boîtier de transm. RFG 2400
2020091	Scatola trasm. RFG 2600/2800	Gear box RFG 2600/2800	Getriebe RFG 2600/2800	Caja de engran. RFG 2600/2800	Boîtier de transm. RFG 2600/2800
2020090	Scatola trasmissione RFG 3000	Gear box RFG 3000	Getriebe RFG 3000	Caja de engranajes RFG 3000	Boîtier de transm. RFG 3000



cod. 2050264
On request

Kit ruote in gomma pivotanti
Pivoting rubber wheels kit
Satz schwenkbare Gummiräder
Kit de ruedas en goma, pivotantes
Kit roues pivotantes en caoutchouc

cod. 2050831 - cod. 2050832
On request

Kit ingombro macchina
Overall dimensions machine kit
Kit Warntafeln
Kit éclairage et signalisation
Dispositivos dimensiones máx. de la máquina

Impiego Use Verwendung Uso Utilisation

La trinciaerba reversibile TRP è una macchina studiata per essere applicata a trattori di medio-alta potenza, sia frontalmente sia posteriormente. Si presta in modo ottimale per la triturazione di erba, mais, paglia, residui di potatura (in uliveti, frutteti, ecc.), sterpaglie e molto altro.

The TRP reversible mulcher is designed for front or rear mounting on medium to high power tractors. It is ideal for mulching grass, maize, hay, pruning waste (in olive groves, orchards, etc.), brushwood and more besides.

Das TRP Mulchgerät ist für den Front- und Heckanbau an Traktoren mit mittlerer und hoher Leistungsstärke ausgelegt. TRP ist ein vielseitiges Gerät für die Zerkleinerung von Stroh, Maisstroh, Reisig, Gestrüpp und mehr.

La trituradora reversible TRP es una máquina diseñada para ser aplicada en la parte delantera o trasera de los tractores de potencia medio alta. Es excelente para la trituración de hierba, maíz, paja, residuos de poda (en olivares, frutales, etc.), malezas y mucho más.

Le broyeur d'herbe réversible TRP est conçu pour être monté sur des tracteurs de moyenne-haute puissance, aussi bien à l'avant qu'à l'arrière. Il est particulièrement indiqué pour le broyage d'herbe, maïs, paille, déchets d'élagage (dans les oliveraies, les vergers, etc.), de broussailles et autres végétaux.



30 cm

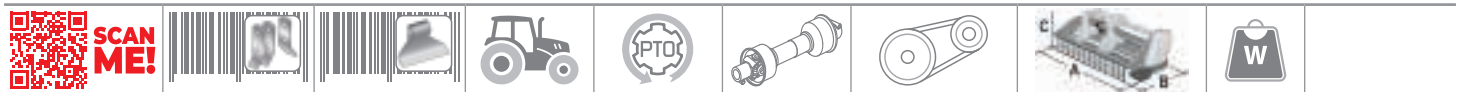
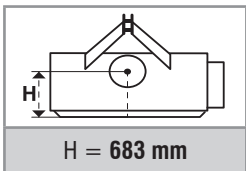

mod.	cod.	cod.	HP	rpm/min	type	nr (type)	cm	kg
TRP 1650	1002349	1002348	50 - 120	540/1000	T-50	4 (XPB 1500)	185×120×110	750
TRP 1850	1002351	1002350	50 - 120	540/1000	T-60	4 (XPB 1500)	205×120×110	790
TRP 2100	1002353	1002352	60 - 120	540/1000	T-60	5 (XPB 1500)	230×120×110	875
TRP 2300	1002355	1002354	60 - 120	540/1000	T-70	5 (XPB 1500)	250×120×110	930
TRP 2500	1002525	1002524	70 - 130	540/1000	T-70	5 (XPB 1700)	280×120×110	1050
TRP 2800	1002527	1002526	80 - 130	540/1000	T-70	5 (XPB 1700)	300×120×110	1150

Nota: specificare se PTO 540 giri/min o PTO 1000 giri/min

Note: Specify PTO speed: 540 rpm or 1000 rpm.

Anmerkung: Bitte angeben, ob die Zapfwelle mit Drehzahl 540 U/min oder 1000 U/min gewünscht ist.

Nota: especificar si la toma de fuerza es de 540 r.p.m. o de 1000 r.p.m.

Note: préciser l'option PDF à 540 tours/min ou à 1000 tours/min.

Di serie	Standard equipment	Serienmässig	Estándar	De série
<ul style="list-style-type: none"> Scatola di trasmissione con doppia ruota libera PTO 1 3/8" Z6 Rotore con sistema di taglio lineare Spostamento su barre cromate Spostamento laterale meccanico Doppia fila di pettini rompitori Aste di raccolta sarmenti Slitte d'appoggio regolabili in altezza Rullo ozioso posteriore regolabile in altezza (194 mm) Raschiafango per pulizia rullo ozioso Scarico anteriore rullo ozioso Telaio con doppia lamiera Protezione anteriore a bandinelle e catene Protezioni antinfortunistiche conformi alla normativa CE 	<ul style="list-style-type: none"> Gearbox with double freewheel clutch PTO 1 3/8" Z6 Rotor with linear cutting system Side shift on chrome bars Mechanical side shift Double row counter-blades Self levelling blade Height-adjustable skids Rear levelling roller height adjustable (194 mm) Scraper for rear levelling roller Discharge of the material over the levelling roller Double skinned frame Front protection with metal flaps and chains Protective equipment as per EC safety rules 	<ul style="list-style-type: none"> Getriebe mit doppeltem Freilauf PTO 1 3/8" Z6 Rotor mit linear Schnittsystem Seitenverschiebung über Chromstangen Mechanische Seitenverschiebung 2 Reihen Gegenschneide Holzreuchen Höhenverstellbare Stützkufen Hintere Stützwalze höhenverstellbar (194 mm) Walzenabstreifer Entladung des Materials über die Walze Doppelwandiger Rahmen Frontschutz mit Metallklappen und Ketten Unfallschutz nach EU-Vorschriften 	<ul style="list-style-type: none"> Caja de engranajes con doble rueda libre TDF 1 3/8" Z6 Rotor con sistema de corte lineal Desplazamiento sobre tubo cromado Desplazamiento lateral mecánico Doble fila de rompedores Rastrillo recoge sarmientos Patines de apoyo regulable en altura Rodillo nivelador trasero (194 mm), con regulación en altura Limpiador montado en el rodillo nivelador trasero Descarga anterior al rodillo nivelador Interior del cuerpo de maquina, con doble chapa Protección delantera a placas metálicas y cadenas Protecciones de seguridad de acuerdo con la norma CE 	<ul style="list-style-type: none"> Boîtier de transmission avec double roue libre PDF 1 3/8" Z6 Rotor avec système de coupe linéaire Déplacement avec barre chromée Déport latéral mécanique Double rangée de peignes Tige de ramassage Patins d'appui réglables en hauteur Rouleau d'appui arrière réglable en hauteur (194 mm) Racleur pour le rouleau d'appui Ejection devant le rouleau d'appui Caisson renforcé par blindage interne Protection avant avec volets métalliques et chaînes Protections contre les accidents aux normes CE

TRP	REVERSIBLE MULCHER HEAVY DUTY
TRP	MULCHGERÄTE FÜR FRONT-UND HECKANBAU EXTRASCHWERE AUSFÜHRUNG
TRP	TRITURADORA REVERSIBLE PESADA
TRP	BROYEUR RÉVERSIBLE LOURD



ORIGINAL MADE IN ITALY

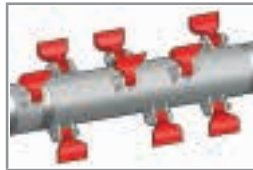
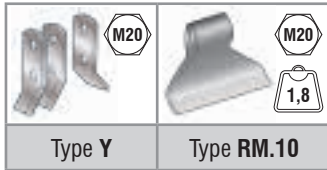
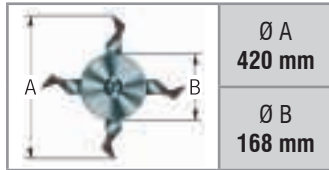

Sistema di taglio lineare
Linear cutting system
Linearrotor
Sistema de corte lineal
Système de coupe linéaire

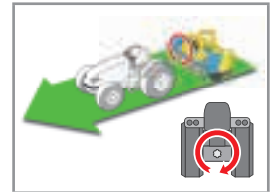

MOD	MOVEMENT MACHINE				
	cm		cm		cm
TRP 1650	90	95	60	125	30
TRP 1850	90	115	60	145	30
TRP 2100	105	125	65	165	40
TRP 2300	105	145	65	185	40
TRP 2500	149	131	109	171	40
TRP 2800	160	140	120	180	40

WORKING WIDTH	Standard			
	cm	nr	nr	nr
165	42	14	14	
185	48	16	16	
210	54	18	18	
230	60	20	20	
250	66	22	23	
280	72	24	25	

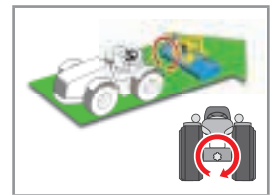
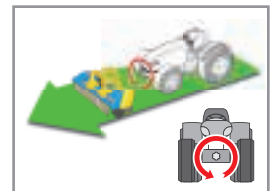

cod.	A richiesta	On request	Auf Anfrage	Opcionales	Sur demande
5130005	Cardano T-50	PTO shaft T-50	Gelenkwelle T-50	Cardán T-50	Cardan T-50
5130009	Cardano T-60	PTO shaft T-60	Gelenkwelle T-60	Cardán T-60	Cardan T-60
5130010	Cardano T-70	PTO shaft T-70	Gelenkwelle T-70	Cardán T-70	Cardan T-70
2050091	Kit ruote in gomma pivottanti	Pivoting rubber wheels kit	Satz schwenkbare Gummiräder	Kit de ruedas en goma, pivotantes	Kit roues pivotantes en caoutchouc
2050010	Gruppo spost. idr. 30 cm	Hydraulic side shift 30 cm	Hydraulische Verschiebung 30 cm	Kit desplazador hidr. 30 cm	Groupe de dépl. lat. 30 cm
2050011	Gruppo spost. idr. 40 cm	Hydraulic side shift 40 cm	Hydraulische Verschiebung 40 cm	Kit desplazador hidr. 40 cm	Groupe de dépl. lat. 40 cm

cod.	Ricambi	Spare parts	Ersatzteile	Recambios	Pièces de rechange
5354044	Cinghia XPB-1500	Cug belt XPB-1500	Keilriemen XPB-1500	Correa XPB-1500	Courroie XPB-1500
5354068	Cinghia XPB-1700	Cug belt XPB-1700	Keilriemen XPB-1700	Correa XPB-1700	Courroie XPB-1700
5315093	Vite M20 per utensile	M20 screw for tool	M20 Schraube für Werkzeug	Tornillo M20 para herramienta	Vis M20 pour outil
5323018	Dado M20 per utensile	M20 nut for tool	M20 Mutter für Werkzeug	Tuerca M20 para herramienta	Ecrou M20 pour outil
5350038	Mazza RM.10	Hammer RM.10	Hammer RM.10	Martillo RM.10	Marteau RM.10
5350040	Coltello "Y"	"Y" blade	"Y" Messer	Cuchilla "Y"	Couteau "Y"
2020040	Scatola trasm. TRP 1650/1850	Gear box TRP 1650/1850	Getriebe TRP 1650/1850	Caja de engran. TRP 1650/1850	Boîtier de transm. TRP 1650/1850
2020041	Scatola trasmissione TRP 2100	Gear box TRP 2100	Getriebe TRP 2100	Caja de engranajes TRP 2100	Boîtier de transm. TRP 2100
2020042	Scatola trasmissione TRP 2300	Gear box TRP 2300	Getriebe TRP 2300	Caja de engranajes TRP 2300	Boîtier de transm. TRP 2300
2020168	Scatola trasmissione TRP 2500	Gear box TRP 2500	Getriebe TRP 2500	Caja de engranajes TRP 2500	Boîtier de transm. TRP 2500
2020169	Scatola trasmissione TRP 2800	Gear box TRP 2800	Getriebe TRP 2800	Caja de engranajes TRP 2800	Boîtier de transm. TRP 2800



cod. 2050091 **On request**
Kit ruote in gomma pivottanti
Pivoting rubber wheels kit
Satz schwenkbare Gummiräder
Kit de ruedas en goma, pivotantes
Kit roues pivotantes en caoutchouc



Impiego

La trinciaerba reversibile TMR è una macchina studiata per essere applicata a trattori di medio-alta potenza, sia frontalmente sia posteriormente. Si presta in modo ottimale per la triturazione di residui di potatura e può essere utilizzata su qualsiasi terreno, anche di tipo sassoso.

Use

The TMR reversible mulcher is designed for front or rear mounting on medium to high power tractors. It is ideal for shredding pruning waste and can be used over all kinds of terrain, including stony ground.

Verwendung

Das TMR Mulchgerät ist für den Front- und Heckanbau an Traktoren mit mittlerer und hoher Leistungsstärke ausgelegt. Der TMR Mulchgerät eignet sich ideal für die Zerkleinerung von Schnittresten und kann auf jedem, auch steinigem, Gelände eingesetzt werden.

Uso

La trituradora reversible TMR es una máquina diseñada para ser aplicada en la parte delantera o trasera de los tractores de potencia medio alta. Es excelente para triturar de manera ideal los residuos de poda y se puede utilizar en cualquier tipo de terreno, inclusive pedregoso.

Utilisation

Le broyeur d'herbe réversible TMR est conçu pour être monté sur des tracteurs de moyenne-haute puissance, aussi bien à l'avant qu'à l'arrière. Il est idéal en particulier pour le broyage de résidus d'élagage et peut être utilisé sur n'importe quel terrain, y compris de type caillouteux.

TMR



30 cm

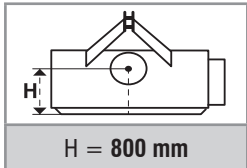

SCAN ME!

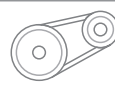
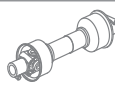

mod.	cod.	HP	rpm/min	type	nr (type)	cm	kg
TMR 1400	1002519	50 - 110	540/1000	T-60	4 (XPB 1690)	165×130×115	860
TMR 2600	1002839	90 - 130	540/1000	T-70	6 (XPB 1690)	280×130×115	1170

Nota: specificare se PTO 540 giri/min o PTO 1000 giri/min

Note: Specify PTO speed: 540 rpm or 1000 rpm.

Anmerkung: Bitte angeben, ob die Zapfwelle mit Drehzahl 540 U/min oder 1000 U/min gewünscht ist.

Nota: especificar si la toma de fuerza es de 540 r.p.m. o de 1000 r.p.m.

Note: préciser l'option PDF à 540 tours/min ou à 1000 tours/min.

Di serie	Standard equipment	Serienmässig	Estándar	De série
<ul style="list-style-type: none"> Scatola di trasmissione con doppia ruota libera PTO 1 3/8" Z6 Rotore con sistema di taglio lineare Spostamento su barre cromate Spostamento laterale meccanico Tripla fila di pettini rompitori Aste di raccolta sarmenti Slitte d'appoggio regolabili in altezza Rullo ozioso posteriore regolabile in altezza (194 mm) Raschifango per pulizia rullo ozioso Scarico anteriore rullo ozioso Telaio con doppia lamiera Protezione anteriore a bandinelle e catene Protezioni antinfortunistiche conformi alla normativa CE 	<ul style="list-style-type: none"> Gearbox with double freewheel clutch PTO 1 3/8" Z6 Rotor with linear cutting system Side shift on chrome bars Mechanical side shift Triple row counter-blades Self levelling blade Height-adjustable skids Rear levelling roller height adjustable (194 mm) Scraper for rear levelling roller Discharge of the material over the levelling roller Double skinned frame Front protection with metal flaps and chains Protective equipment as per EC safety rules 	<ul style="list-style-type: none"> Getriebe mit doppeltem Freilauf PTO 1 3/8" Z6 Rotor mit linear Schnittsystem Seitenverschiebung über Chromstangen Mechanische Seitenverschiebung 3 Reihen Gegenschneide Holzreuchen Höhenverstellbare Stützkufen Hinterer Stützwalze höhenverstellbar (194 mm) Walzenabstreifer Entladung des Materials über die Walze Doppelwandiger Rahmen Frontschutz mit Metallklappen und Ketten Unfallschutz nach EU-Vorschriften 	<ul style="list-style-type: none"> Caja de engranajes con doble rueda libre TDF 1 3/8" Z6 Rotor con sistema de corte lineal Desplazamiento sobre tubo cromado Desplazamiento lateral mecánico Triple fila de rompedores Rastrillo recoge sarmentos Patines de apoyo regulable en altura Rodillo nivelador trasero (194 mm), con regulación en altura Limpiador montado en el rodillo nivelador trasero Descarga anterior al rodillo nivelador Interior del cuerpo de maquina, con doble chapa Protección delantera a placas metálicas y cadenas Protecciones de seguridad de acuerdo con la norma CE 	<ul style="list-style-type: none"> Boîtier de transmission avec double roue libre PDF 1 3/8" Z6 Rotor avec système de coupe linéaire Déplacement avec barre chromée Déport latéral mécanique Triple rangée de peignes Tige de ramassage Patins d'appui réglables en hauteur Rouleau d'appui arrière réglable en hauteur (194 mm) Racleur pour le rouleau d'appui Ejection devant le rouleau d'appui Caisson renforcé par blindage interne Protection avant avec volets métalliques et chaînes Protections contre les accidents aux normes CE

TMR	REVERSIBLE MULCHER EXTRA HEAVY DUTY
TMR	MULCHGERÄTE FÜR FRONT-UND HECKANBAU EXTRASCHWERE AUSFÜHRUNG
TMR	TRITURADORA REVERSIBLE PESADA
TMR	BROYEUR RÉVERSIBLE LOURD



ORIGINAL MADE IN ITALY

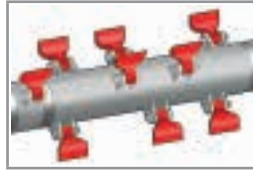
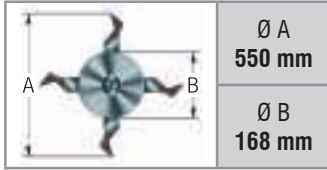

Sistema di taglio lineare
Linear cutting system
Linearroter
Sistema de corte lineal
Système de coupe linéaire

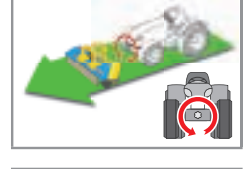

TMR

MOD	MOVEMENT MACHINE				WORKING WIDTH		
	Standard		Standard				
mod.	cm	cm	cm	cm	nr	nr	
TMR 1400	91	74	61	104	30	10	12
TMR 2600	155	125	115	165	40	22	22

cod.	A richiesta	On request	Auf Anfrage	Opcionales	Sur demande
5130009	Cardano T-60	PTO shaft T-60	Gelenkwelle T-60	Cardán T-60	Cardan T-60
5130010	Cardano T-70	PTO shaft T-70	Gelenkwelle T-70	Cardán T-70	Cardan T-70
2050093	Kit ruote in acciaio pivotanti	Pivoting steel wheels kit	Satz schwenkbare Stahlräder	Kit de ruedas en hierro, giratorias	Kit roues pivotantes en acier
2050010	Gruppo spost. idr. 30 cm	Hydraulic side shift 30 cm	Hydraulische Verschiebung 30 cm	Kit desplazador hidr. 30 cm	Groupe de dépl. lat. 30 cm
2050011	Gruppo spost. idr. 40 cm	Hydraulic side shift 40 cm	Hydraulische Verschiebung 40 cm	Kit desplazador hidr. 40 cm	Groupe de dépl. lat. 40 cm

cod.	Ricambi	Spare parts	Ersatzteile	Recambios	Pièces de rechange
5354058	Cinghia XPB-1690	Cug belt XPB-1690	Keilriemen XPB-1690	Correa XPB-1690	Courroie XPB-1690
5315550	Vite M20 per utensile	M20 screw for tool	M20 Schraube für Werkzeug	Tornillo M20 para herramienta	Vis M20 pour outil
5323018	Dado M20 per utensile	M20 nut for tool	M20 Mutter für Werkzeug	Tuerca M20 para herramienta	Ecrou M20 pour outil
5350098	Mazza RM.69	Hammer RM.69	Hammer RM.69	Martillo RM.69	Marteau RM.69
2020040	Scatola trasmissione TMR 1400	Gear box TMR 1400	Getriebe TMR 1400	Caja de engranajes TMR 1400	Boîtier de transm. TMR 1400
2020091	Scatola trasmissione TMR 2600	Gear box TMR 2600	Getriebe TMR 2600	Caja de engranajes TMR 2600	Boîtier de transm. TMR 2600



cod. 2050093
On request

Kit ruote in acciaio pivotanti
Pivoting steel wheels kit
Satz schwenkbare Stahlräder
Kit de ruedas en hierro, giratorias
Kit roues pivotantes en acier



Impiego Use Verwendung Uso Utilisation

La trinciaerba reversibile TMR-PRO è una macchina studiata per essere applicata a trattori di medio-alta potenza, sia frontalmente sia posteriormente. Si presta in modo ottimale per la triturazione di residui di potatura e può essere utilizzata su qualsiasi terreno, anche di tipo sassoso.

The TMR-PRO reversible mulcher is designed for front or rear mounting on medium to high power tractors. It is ideal for shredding pruning waste and can be used over all kinds of terrain, including stony ground.

Das neue TMR-PRO Mulchgerät ist für den Front- und Heckanbau an Traktoren mit mittlerer und hoher Leistungsgstärke ausgelegt. Der TMR-PRO Mulchgerät eignet sich ideal für die Zerkleinerung von Schnittresten und kann auf jedem, auch steinigem, Gelände eingesetzt werden.

La trituradora reversible TMR-PRO es una máquina diseñada para ser aplicada en la parte delantera o trasera de los tractores de potencia medio alta. Es excelente para triturar de manera ideal los residuos de poda y se puede utilizar en cualquier tipo de terreno, inclusive pedregoso.

Le broyeur d'herbe réversible TMR-PRO est conçu pour être monté sur des tracteurs de moyenne-haute puissance, aussi bien à l'avant qu'à l'arrière. Il est idéal en particulier pour le broyage de résidus d'élagage et peut être utilisée sur n'importe quel terrain, y compris de type caillouteux.

Hardox
in my body



30 cm

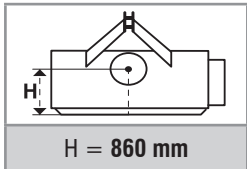

mod.	cod.	HP	rpm/min	type	nr (type)	cm	kg
TMR-PRO 1550	1003062	50 - 150	540/1000	T-60	4 (XPB 1800)	180×130×120	945
TMR-PRO 1850	1003063	60 - 150	540/1000	T-60	5 (XPB 1800)	205×130×120	1065
TMR-PRO 2050	1003064	70 - 150	540/1000	T-60	5 (XPB 1800)	225×130×120	1149
TMR-PRO 2300	1003065	80 - 150	540/1000	T-70	6 (XPB 1800)	250×130×120	1230
TMR-PRO 2600	1003066	90 - 150	540/1000	T-70	6 (XPB 1800)	280×130×120	1370

Nota: specificare se PTO 540 giri/min o PTO 1000 giri/min

Note: Specify PTO speed: 540 rpm or 1000 rpm.

Anmerkung: Bitte angeben, ob die Zapfwelle mit Drehzahl 540 U/min oder 1000 U/min gewünscht ist.

Nota: especificar si la toma de fuerza es de 540 r.p.m. o de 1000 r.p.m.

Note: préciser l'option PDF à 540 tours/min ou à 1000 tours/min.

Di serie	Standard equipment	Serienmässig	Estándar	De série
<ul style="list-style-type: none"> Scatola di trasmissione super rinforzata con doppia ruota libera PTO 1 3/8" Z6 Rotore con sistema di taglio lineare Spostamento su barre cromate Spostamento laterale meccanico 4 file di pettini rompitori in HARDOX Aste di raccolta sarmanti Slitte d'appoggio in HARDOX regolabili in altezza Rullo ozioso posteriore regolabile in altezza (194 mm) Raschiafango per pulizia rullo ozioso Scarico anteriore rullo ozioso Telaio con doppia lamiera Protezione anteriore a bandinelle e catene Protezioni antinfortunistiche conformi alla normativa CE 	<ul style="list-style-type: none"> Super reinforced gearbox with double freewheel clutch PTO 1 3/8" Z6 Rotor with linear cutting system Side shift on chrome bars Mechanical side shift 4 row counter-blades Self levelling blade Height-adjustable HARDOX skids Rear levelling roller height adjustable (194 mm) Scraper for rear levelling roller Discharge of the material over the levelling roller Double skinned frame Front protection with metal flaps and chains Protective equipment as per EC safety rules 	<ul style="list-style-type: none"> Superverstärkter Getriebe mit doppeltem Freilauf PTO 1 3/8" Z6 Rotor mit linear Schnittsystem Seitenverschiebung über Chromstangen Mechanische Seitenverschiebung 4 Reihen Gegenschneide Holzrechen Höhenverstellbare HARDOX-Stützkufen Hintere Stützwalze höhenverstellbar (194 mm) Walzenabstreifer Entladung des Materials über die Walze Doppelwandiger Rahmen Frontschutz mit Metallklappen und Ketten Unfallschutz nach EU-Vorschriften 	<ul style="list-style-type: none"> Caja de engranajes súper reforzada con doble rueda libre TDF 1 3/8" Z6 Rotor con sistema de corte lineal Desplazamiento sobre tubo cromado Desplazamiento lateral mecánico 4 fila de rompedores Rastrillo recoge sarmientos Patines de apoyo HARDOX regulable en altura Rodillo nivelador trasero (194 mm), con regulación en altura Limpiador montado en el rodillo nivelador trasero Descarga anterior al rodillo nivelador Interior del cuerpo de máquina, con doble chapa Protección delantera a placas metálicas y cadenas Protecciones de seguridad de acuerdo con la norma CE 	<ul style="list-style-type: none"> Boîtier de transmission super renforcée avec double roue libre PDF 1 3/8" Z6 Rotor avec système de coupe linéaire Déplacement avec barre chromée Déport latéral mécanique 4 rangée de peignes Tige de ramassage Patins d'appui HARDOX réglables en hauteur Rouleau d'appui arrière réglable en hauteur (194 mm) Racleur pour le rouleau d'appui Ejection devant le rouleau d'appui Caisson renforcé par blindage interne Protection avant avec volets métalliques et chaînes Protections contre les accidents aux normes CE

TMR-PRO	REVERSIBLE MULCHER EXTRA HEAVY DUTY
TMR-PRO	MULCHGERÄTE FÜR FRONT-UND HECKANBAU EXTRASCHWERE AUSFÜHRUNG
TMR-PRO	TRITURADORA REVERSIBLE PESADA
TMR-PRO	BROYEUR RÉVERSIBLE LOURD

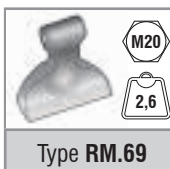
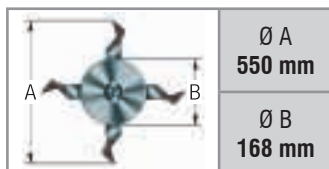

Sistema di taglio lineare
Linear cutting system
Linearrotor
Sistema de corte lineal
Système de coupe linéaire

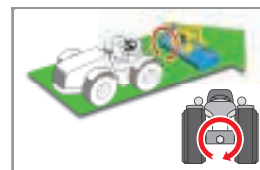
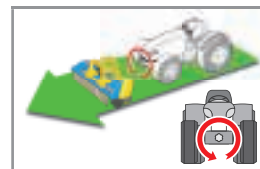

TMR-PRO

MOD	MOVEMENT MACHINE				WORKING WIDTH	Standard		
	cm	cm	cm	cm		nr	nr	
TMR-PRO 1550	105	75	75	105	30	155	12	13
TMR-PRO 1850	107	98	77	128	30	185	14	15
TMR-PRO 2050	134	91	94	131	40	205	16	17
TMR-PRO 2300	135	115	95	75	40	230	18	19
TMR-PRO 2600	151	119	121	79	40	260	22	24

cod.	A richiesta	On request	Auf Anfrage	Opcionales	Sur demande
5130009	Cardano T-60	PTO shaft T-60	Gelenkwelle T-60	Cardán T-60	Cardan T-60
5130010	Cardano T-70	PTO shaft T-70	Gelenkwelle T-70	Cardán T-70	Cardan T-70
2050093	Kit ruote in acciaio pivotanti	Pivoting steel wheels kit	Satz schwenkbare Stahlräder	Kit de ruedas en hierro, giratorias	Kit roues pivotantes en acier
2050010	Gruppo spost. idr. 30 cm	Hydraulic side shift 30 cm	Hydraulische Verschiebung 30 cm	Kit desplazador hidr. 30 cm	Groupe de dépl. lat. 30 cm
2050011	Gruppo spost. idr. 40 cm	Hydraulic side shift 40 cm	Hydraulische Verschiebung 40 cm	Kit desplazador hidr. 40 cm	Groupe de dépl. lat. 40 cm

cod.	Ricambi	Spare parts	Ersatzteile	Recambios	Pièces de rechange
5354045	Cinghia XPB-1800	Cug belt XPB-1800	Keilriemen XPB-1800	Correa XPB-1800	Courroie XPB-1800
5315550	Vite M20 per utensile	M20 screw for tool	M20 Schraube für Werkzeug	Tornillo M20 para herramienta	Vis M20 pour outil
5323018	Dado M20 per utensile	M20 nut for tool	M20 Mutter für Werkzeug	Tuerca M20 para herramienta	Ecrou M20 pour outil
5350098	Mazza RM.69	Hammer RM.69	Hammer RM.69	Martillo RM.69	Marteau RM.69
2020139	Sc. trasm. TMR-PRO 1550/1850	Gear box TMR-PRO 1550/1850	Getriebe TMR-PRO 1550/1850	Caja de engran. 1550/1850	Boîtier de transm. 1550/1850
2020168	Sc. trasm. TMR-PRO 2050/2300	Gear box TMR-PRO 2050/2300	Getriebe TMR-PRO 2050/2300	Caja de engran. 2050/2300	Boîtier de transm. 2050/2300
2020169	Sc. trasm. TMR-PRO 2600	Gear box TMR-PRO 2600	Getriebe TMR-PRO 2600	Caja de engran. 2600	Boîtier de transm. 2600



cod. 2050093 **On request**
Kit ruote in acciaio pivotanti
Pivoting steel wheels kit
Satz schwenkbare Stahlräder
Kit de ruedas en hierro, giratorias
Kit roues pivotantes en acier

Impiego	Use	Verwendung	Uso	Utilisation
---------	-----	------------	-----	-------------

La trinciatrice TCK è pensata per la triturazione di residui di potatura e per operare su qualsiasi tipo di terreno, coltivato e non, disconnesso o sassoso. È disponibile solo la versione con mazze.

The TCK mulcher is designed to shredding pruning waste and is ideal for use on all kinds of terrain, including cultivated, fallow, rough and stony ground. The mulching rotor is only available with hammers.

Der TCK pick-up Mulcher eignet sich ideal für die Zerkleinerung von Schnittresten und kann auf jedem, auch steinigem, Gelände eingesetzt werden. Die Maschine wird nur mit Hammerschlägel geliefert.

La trituradora TCK ha sido diseñada para la trituration de residuos de poda y para trabajar en cualquier tipo de terreno cultivado o no cultivado, irregular o pedregoso. Está disponible únicamente la versión con martillos.

Le broyeur TCK est indiqué pour le broyage de résidus d'élagage et il est conçu pour travailler sur n'importe quel type de terrain, cultivé ou pas, accidenté ou caillouteux. Il est disponible uniquement la version équipée de marteaux.

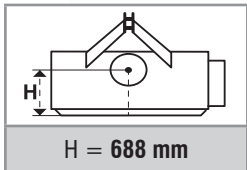

mod.	cod.	HP	rpm/min	type	nr (type)	cm	kg
TCK 1000	1002538	50 - 100	540/1000	T-50	3 (SPB 1280)	124×135×105	450
TCK 1300	1002539	60 - 120	540/1000	T-50	3 (SPB 1280)	154×135×105	650
TCK 1500	1002540	70 - 120	540/1000	T-50	4 (SPB 1280)	170×135×105	750
TCK 1800	1002541	80 - 120	540/1000	T-60	5 (SPB 1280)	200×135×105	850
TCK 2100	1002542	90 - 120	540/1000	T-60	5 (SPB 1280)	230×135×105	950

Di serie	Standard equipment	Serienmässig	Estándar	De série
<ul style="list-style-type: none"> Scatola di trasmissione con ruota libera PTO 1 3/8" Z6 Rotore con sistema di taglio elicoidale Castello fisso Doppia fila di pettini rompitori Slitte d'appoggio regolabili in altezza Rullo pick-up idraulico singolo Spuntoni di raccolta Cofano apribile (solo per ispezione) Griglia di scarico a fori calibrati Protezioni antinfortunistiche conformi alla normativa CE 	<ul style="list-style-type: none"> Gearbox with freewheel clutch PTO 1 3/8" Z6 Rotor with helical cutting system 3-point linkage fixed Double row counter-blades Height-adjustable skids Hydraulically powered pick-up roller Harvesting spikes Opening hood (for inspection only) Discharge grill with calibrated holes Protective equipment as per EC safety rules 	<ul style="list-style-type: none"> Getriebe mit integriertem Freilauf PTO 1 3/8" Z6 Spiralrotor Anbaubock fest 2 Reihen Gegenschneide Höhenverstellbare Stützkufen Hydraulisch angetriebene Aufnahmewalze Ripperzähne Heckhaube (darf nur für Wartungsarbeiten geöffnet werden) Entladegitter mit kalibrierten Löchern Unfallschutz nach EU-Vorschriften 	<ul style="list-style-type: none"> Caja de engranajes con rueda libre TDF 1 3/8" Z6 Rotor con sistema de corte helicoidal Arco de tercer punto fijo Doble fila de rompedores Patines de apoyo regulable en altura Pick-up de accionamiento hidráulico Púas de recogida Portón trasero aperturable (solo para inspección) Criba de descarga con agujeros calibrados Protecciones de seguridad de acuerdo con la norma CE 	<ul style="list-style-type: none"> Boîtier de transmission avec roue libre PDF 1 3/8" Z6 Rotor avec système de coupe hélicoïdal Châssis fixe Double rangée de peignes Patins d'appui réglables en hauteur Rouleau pick-up hydraulique Dents de ramassage Capot ouvrant (pour inspection seulement) Grille de déchargement à trous calibrés Protections contre les accidents aux normes CE

TCK	MULCHER FOR VINEYARDS AND ORCHARDS WITH PICK-UP
TCK	MULCHER HECKANBAU FÜR WEIN-UND OBSTANBAU MIT PICK-UP
TCK	TRITURADORA PARA VIÑEDOS Y PLANTACIONES FRUTALES CON ALIMENTACIÓN PICK-UP
TCK	BROYEUR POUR VIGNES ET VERGERS HORS SOL AVEC ALIMENTATION PICK-UP

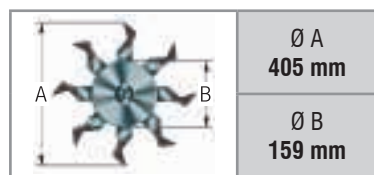

Ø A
405 mm

Ø B
159 mm

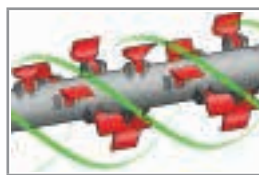

Sistema di taglio elicoidale
Helical cutting system
Spiralrotor
Sistema de corte helicoidal
Système de coupe hélicoïdal



MOVEMENT MACHINE		WORKING WIDTH	Standard	Standard
MOD				
mod.	cm	cm	nr	nr
TCK 1000	62	100	12	6
TCK 1300	77	130	16	8
TCK 1500	85	150	18	8
TCK 1800	100	180	22	10
TCK 2100	115	210	26	12

cod.	A richiesta	On request	Auf Anfrage	Opcionales	Sur demande
5130032	Cardano T-50 con bullone di sicurezza	PTO shaft T-50 with bolt safety	Gelenkwelle T-50 mit Bolzensicherung	Cardán T-50 con perno de seguridad	Cardan T-50 avec boulon de sécurité
5130009	Cardano T-60	PTO shaft T-60	Gelenkwelle T-60	Cardán T-60	Cardan T-60
2050012	Kit ruote posteriori in gomma sterzanti	Rear rubber steering wheels kit	Satz hintere Gummilenkräder	Kit de ruedas traseras, en goma, direccionales	Kit roues arrière directrices en caoutchouc

cod.	Ricambi	Spare parts	Ersatzteile	Recambios	Pièces de rechange
5354070	Cinghia SPB-1280	Cug belt SPB-1280	Keilriemen SPB-1280	Correa SPB-1280	Courroie SPB-1280
5315011	Vite M14 per utensile	M14 screw for tool	M14 Schraube für Werkzeug	Tornillo M14 para herramienta	Vis M14 pour outil
5323016	Dado M14 per utensile	M14 nut for tool	M14 Mutter für Werkzeug	Tuerca M14 para herramienta	Ecrou M14 pour outil
5350024	Mazza RM.8	Hammer RM.8	Hammer RM.8	Martillo RM.8	Marteau RM.8
5215367	Spuntoni di raccolta (senza supporto)	Harvesting spikes (without holder)	Ripperzähne (ohne Halterung)	Púas de recogida (sin soporte)	Dents de ramassage (sans support)
3230986	Supporti spuntoni di raccolta	Teeth holder	Halterung Ripperzähne	Soportes púas de recogida	Supports dents de ramassage
2020070	Scatola tras. TCK 1000	Gear box TCK 1000	Getriebe TCK 1000	Caja de eng. TCK 1000	Boîtier de transm. TCK 1000
2020071	Scatola tras. TCK 1300	Gear box TCK 1300	Getriebe TCK 1300	Caja de eng. TCK 1300	Boîtier de transm. TCK 1300
2020072	Scatola tras. TCK 1500	Gear box TCK 1500	Getriebe TCK 1500	Caja de eng. TCK 1500	Boîtier de transm. TCK 1500
2020073	Scatola tras. TCK 1800	Gear box TCK 1800	Getriebe TCK 1800	Caja de eng. TCK 1800	Boîtier de transm. TCK 1800
2020074	Scatola tras. TCK 2100	Gear box TCK 2100	Getriebe TCK 2100	Caja de eng. TCK 2100	Boîtier de transm. TCK 2100
5023089	Motore idraulico	Hydraulic motor	Hydraulikmotor	Motor hidraulico	Moteur hydraulique



cod. 2050012
On request

Kit ruote posteriori in gomma sterzanti
Rear rubber steering wheels kit
Satz hintere gummilenkräder
Kit de ruedas traseras, en goma, direccionales
Kit roues arrière directrices en caoutchouc



TLK

Impiego **Use** **Verwendung** **Uso** **Utilisation**

La trinciatrice reversibile TLK si presta in modo ottimale per la triturazione di residui di potatura e può essere utilizzata su qualsiasi terreno, anche di tipo sassoso.

The TLK reversible mulcher is ideal for shredding pruning waste and can be used over all kinds of terrain, including stony ground.

Der TLK pick-up Mulcher eignet sich ideal für die Zerkleinerung von Schnittresten und kann auf jedem, auch steinigem, Gelände eingesetzt werden.

La trituradora reversible TLK sirve para triturar de manera ideal los residuos de poda y se puede utilizar en cualquier tipo de terreno, inclusive pedregoso.

Le broyeur réversible TLK est idéal en particulier pour le broyage de résidus d'élagage et peut être utilisée sur n'importe quel terrain, y compris de type caillouteux.

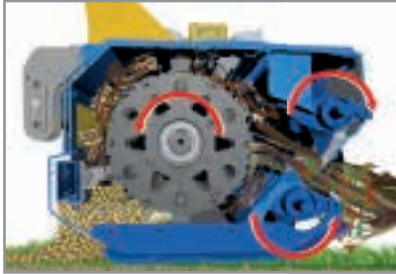

Hardox
in my body

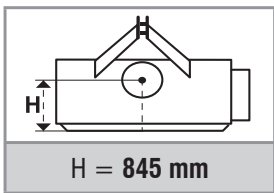
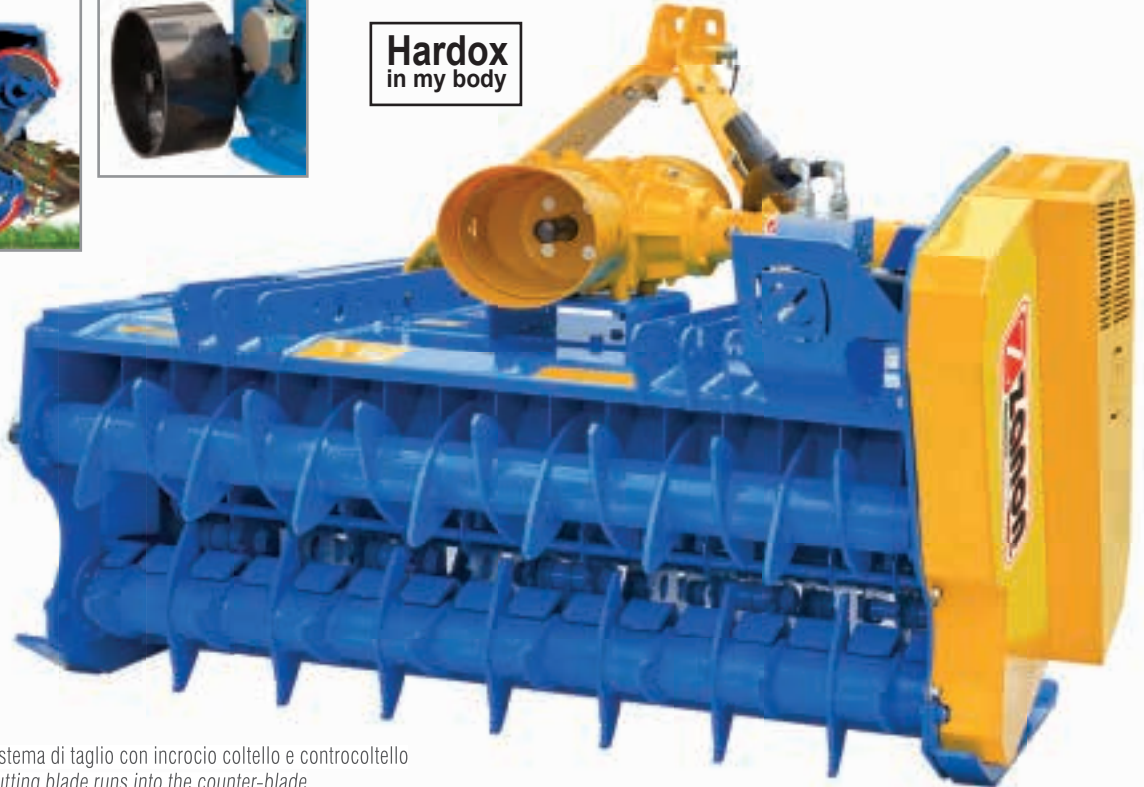



Sistema di taglio con incrocio coltello e controcoltello
Cutting blade runs into the counter-blade
Schnittsystem Messer-Gegenmesser
Sistema de corte con cruce de cuchilla y contra cuchilla
Système de coupe avec croisement couteau et contre couteau



SCAN ME!







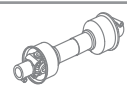

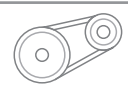







mod.	cod.	HP	rpm/min	type	nr (type)	cm	kg
TLK 1300	1002871	70 - 130	540/1000	T-60	4 (SPB 1650)	161×134×120	810
TLK 1550	1002855	70 - 130	540/1000	T-60	5 (SPB 1650)	185×134×120	1050
TLK 1800	1002856	73 - 130	540/1000	T-80	5 (SPB 1650)	210×134×120	1150

Nota: specificare se PTO 540 giri/min o PTO 1000 giri/min

Note: Specify PTO speed: 540 rpm or 1000 rpm.

Anmerkung: Bitte angeben, ob die Zapfwelle mit Drehzahl 540 U/min oder 1000 U/min gewünscht ist.

Nota: especificar si la toma de fuerza es de 540 r.p.m. o de 1000 r.p.m.

Note: préciser l'option PDF à 540 tours/min ou à 1000 tours/min.

Di serie	Standard equipment	Serienmässig	Estándar	De série
<ul style="list-style-type: none"> Scatola di trasmissione con doppia ruota libera PTO 1 3/8" Z6 Rotore con sistema di taglio elicoidale Castello fisso Sistema di taglio con incrocio coltello e controcoltello Slitte d'appoggio fisse Ruote in acciaio fisse Rullo pick up idraulico doppio Cofano apribile (solo per ispezione) Protezioni antinfortunistiche conformi alla normativa CE 	<ul style="list-style-type: none"> Gearbox with double freewheel clutch PTO 1 3/8" Z6 Rotor with helical cutting system 3-point linkage fixed Cutting system with blade and counter-blade crossing Fixed skids Fixed steel wheels Hydraulically powered double pick-up roller Opening hood (for inspection only) Protective equipment as per EC safety rules 	<ul style="list-style-type: none"> Getriebe mit doppeltem Freilauf PTO 1 3/8" Z6 Spiralrotor Anbaubock fest Schneidsystem mit Messer- und Gegenmesserkreuzung Stützkufen fest Satz feste Stahlräder Hydraulisch angetriebene Doppelaufnahmewalze Heckhaube (darf nur für Wartungsarbeiten geöffnet werden) Unfallschutz nach EU-Vorschriften 	<ul style="list-style-type: none"> Caja de engranajes con doble rueda libre TDF 1 3/8" Z6 Rotor con sistema de corte helicoidal Arco de tercer punto fijo Sistema de corte a través del cruce de cuchilla con la contra cuchilla Patines de apoyo fijos Ruedas en hierro, fijas Pick-up doble de accionamiento hidráulico Portón trasero aperturable (solo para inspección) Protecciones de seguridad de acuerdo con la norma CE 	<ul style="list-style-type: none"> Boîtier de transmission avec double roue libre PDF 1 3/8" Z6 Rotor avec système de coupe hélicoïdal Châssis fixe Système de coupe avec couteaux et contre-couteaux Patins d'appui fixes Kit roues fixes en acier Double rouleau pick-up hydraulique Capot ouvrant (pour inspection seulement) Protections contre les accidents aux normes CE

TLK	REVERSIBLE BLADES MULCHER HEAVY DUTY WITH PICK-UP
TLK	MULCHER FÜR FRONT- UND HECKANBAU: AUSFÜHRUNG MIT PICK-UP
TLK	TRITURADORA REVERSIBLE A CUCHILLAS - CON ALIMENTACIÓN PICK-UP
TLK	BROYEUR RÉVERSIBLE HORS SOL À FLÉAUX AVEC ALIMENTATION PICK-UP



ORIGINAL MADE IN ITALY

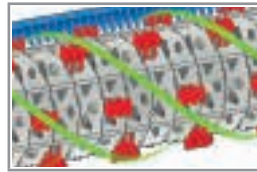
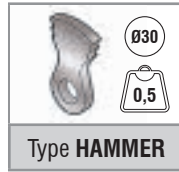
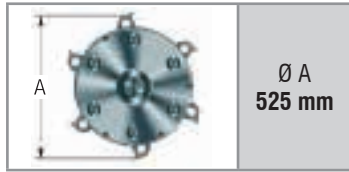

Sistema di taglio elicoidale
Helical cutting system
Spiral rotor
Sistema de corte helicoidal
Système de coupe hélicoïdal



MOD	MOVEMENT MACHINE	
mod.	cm	
TLK 1300	73	88
TLK 1550	90	95
TLK 1800	102	108

WORKING WIDTH	Standard	On request
cm	nr	nr
130	64	12
155	76	14
180	90	18

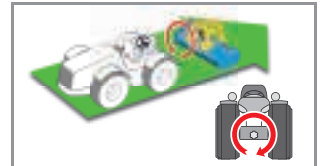

cod.	A richiesta	On request	Auf Anfrage	Opcionales	Sur demande
5130009	Cardano T-60	PTO shaft T-60	Gelenkwelle T-60	Cardán T-60	Cardan T-60
5130019	Cardano T-80	PTO shaft T-80	Gelenkwelle T-80	Cardán T-80	Cardan T-80
2051411	Spuntoni di raccolta TLK 1300	Harvesting spikes TLK 1300	Ripperzähne TLK 1300	Púas de recogida TLK 1300	Dents de ramassage TLK 1300
2051412	Spuntoni di raccolta TLK 1550	Harvesting spikes TLK 1550	Ripperzähne TLK 1550	Púas de recogida TLK 1550	Dents de ramassage TLK 1550
2051413	Spuntoni di raccolta TLK 1800	Harvesting spikes TLK 1800	Ripperzähne TLK 1800	Púas de recogida TLK 1800	Dents de ramassage TLK 1800
2050878	Secondo arco con attacco a tre punti	Second 3-point linkage	Zweiter Dreipunkbock	Arco de tercer punto posterior opcional	Deuxième arc d'attelage 3 points
2050889	Kit ruote in gomma fisse	Fixed rubber wheels kit	Satz feste Gummiräder	Kit de ruedas en goma, fijas	Kit roues fixes en caoutchouc
2050490	Kit ruote in gomma pivotanti	Pivoting rubber wheels kit	Satz schwenkbare Gummiräder	Kit de ruedas en goma, pivotantes	Kit roues pivotantes en caoutchouc
2050517	Rullo ozioso TLK 1300	Levelling roller TLK 1300	Hintere Stützwalze TLK 1300	Rodillo nivelador TLK 1300	Rouleau d'appui TLK 1300
2050518	Rullo ozioso TLK 1550	Levelling roller TLK 1550	Hintere Stützwalze TLK 1550	Rodillo nivelador TLK 1550	Rouleau d'appui TLK 1550
2050519	Rullo ozioso TLK 1800	Levelling roller TLK 1800	Hintere Stützwalze TLK 1800	Rodillo nivelador TLK 1800	Rouleau d'appui TLK 1800

cod.	Ricambi	Spare parts	Ersatzteile	Recambios	Pièces de rechange
5354090	Cinghia SPB 1650	Cug belt SPB 1650	Keilriemen SPB 1650	Correa SPB 1650	Courroie SPB 1650
5229800	Martello rompitore	Hammer	Hammer	Martillo	Marteau
5023086	Motore idraulico	Hydraulic motor	Hydraulikmotor	Motor hidraulico	Moteur hydraulique
2020140	Scatola tras. TLK 1300	Gear box TLK 1300	Getriebe TLK 1300	Caja de eng. TLK 1300	Boîtier de transm. TLK 1300
2020139	Scatola tras. TLK 1550	Gear box TLK 1550	Getriebe TLK 1550	Caja de eng. TLK 1550	Boîtier de transm. TLK 1550
2020138	Scatola tras. TLK 1800	Gear box TLK 1800	Getriebe TLK 1800	Caja de eng. TLK 1800	Boîtier de transm. TLK 1800

cod. 2050889

On request

Kit ruote in gomma fisse
Fixed rubber wheels kit
Satz feste Gummiräder
Kit de ruedas en goma, fijas
Kit roues fixes en caoutchouc



cod. 2050490
On request

Kit ruote in gomma pivotanti
Pivoting rubber wheels kit
Satz schwenkbare Gummiräder
Kit de ruedas en goma, pivotantes
Kit roues pivotantes en caoutchouc



Impiego **Use** **Verwendung** **Uso** **Utilisation**

La trinciatrice reversibile TLK-PRO si presta in modo ottimale per la triturazione di residui di potatura e può essere utilizzata su qualsiasi terreno, anche di tipo sassoso.

The TLK-PRO reversible mulcher is ideal for shredding pruning waste and can be used over all kinds of terrain, including stony ground.

Der TLK-PRO pick-up Mulcher eignet sich ideal für die Zerkleinerung von Schnittresten und kann auf jedem, auch steinigem, Gelände eingesetzt werden.

La trituradora reversible TLK-PRO sirve para triturar de manera ideal los residuos de poda y se puede utilizar en cualquier tipo de terreno, incluso pedregoso.

Le broyeur réversible TLK-PRO est idéal en particulier pour le broyage de résidus d'élagage et peut être utilisée sur n'importe quel terrain, y compris de type caillouteux.

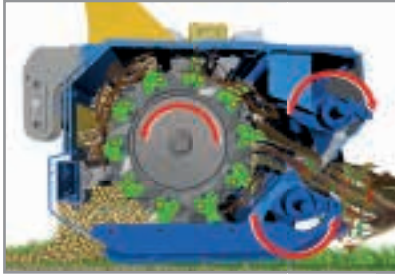

Hardox
in my body

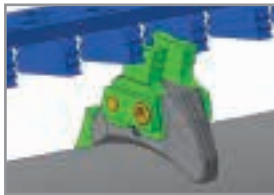
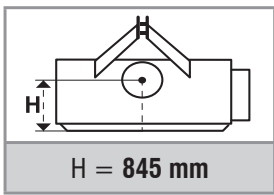

Sistema di taglio con incrocio coltello e controcoltello
Cutting blade runs into the counter-blade
Schnittsystem Messer-Gegenmesser
Sistema de corte con cruce de cuchilla y contra cuchilla
Système de coupe avec croisement couteau et contre couteau

NEW

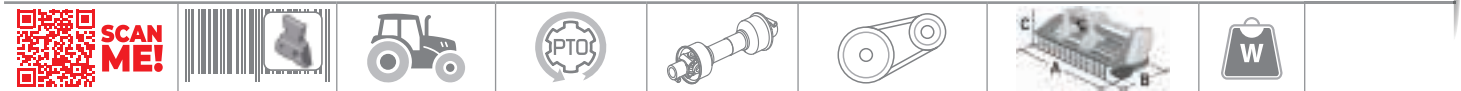

mod.	cod.	HP	rpm/min	type	nr (type)	cm	kg
TLK-PRO 1300	1003298	70 - 130	540/1000	T-60	4 (SPB 1650)	161×134×120	880
TLK-PRO 1550	1003299	70 - 130	540/1000	T-60	5 (SPB 1650)	185×134×120	1120
TLK-PRO 1800	1003300	73 - 130	540/1000	T-80	5 (SPB 1650)	210×134×120	1220

Nota: specificare se PTO 540 giri/min o PTO 1000 giri/min

Note: Specify PTO speed: 540 rpm or 1000 rpm.

Anmerkung: Bitte angeben, ob die Zapfwelle mit Drehzahl 540 U/min oder 1000 U/min gewünscht ist.

Nota: especificar si la toma de fuerza es de 540 r.p.m. o de 1000 r.p.m.

Note: préciser l'option PDF à 540 tours/min ou à 1000 tours/min.

Di serie	Standard equipment	Serienmässig	Estándar	De série
<ul style="list-style-type: none"> Scatola di trasmissione con doppia ruota libera PTO 1 3/8" Z6 Rotore con sistema di taglio elicoidale Castello fisso Sistema di taglio con incrocio coltello e controcoltello Slitte d'appoggio fisse Ruote in acciaio fisse Rullo pick up idraulico doppio Cofano apribile (solo per ispezione) Protezioni antinfortunistiche conformi alla normativa CE 	<ul style="list-style-type: none"> Gearbox with double freewheel clutch PTO 1 3/8" Z6 Rotor with helical cutting system 3-point linkage fixed Cutting system with blade and counter-blade crossing Fixed skids Fixed steel wheels Hydraulically powered double pick-up roller Opening hood (for inspection only) Protective equipment as per EC safety rules 	<ul style="list-style-type: none"> Getriebe mit doppeltem Freilauf PTO 1 3/8" Z6 Spiralrotor Anbaubock fest Schneidsystem mit Messer- und Gegenmesserkreuzung Stützkufen fest Satz feste Stahlräder Hydraulisch angetriebene Doppelaufnahmewalze Heckhaube (darf nur für Wartungsarbeiten geöffnet werden) Unfallschutz nach EU-Vorschriften 	<ul style="list-style-type: none"> Caja de engranajes con doble rueda libre TDF 1 3/8" Z6 Rotor con sistema de corte helicoidal Arco de tercer punto fijo Sistema de corte a través del cruce de cuchilla con la contra cuchilla Patines de apoyo fijos Ruedas en hierro, fijas Pick-up doble de accionamiento hidráulico Portón trasero aperturable (solo para inspección) Protecciones de seguridad de acuerdo con la norma CE 	<ul style="list-style-type: none"> Boîtier de transmission avec double roue libre PDF 1 3/8" Z6 Rotor avec système de coupe hélicoïdal Châssis fixe Système de coupe avec couteaux et contre-couteaux Patins d'appui fixes Kit roues fixes en acier Double rouleau pick-up hydraulique Capot ouvrant (pour inspection seulement) Protections contre les accidents aux normes CE

TLK-PRO	REVERSIBLE FIXED BLADES MULCHER HEAVY DUTY WITH PICK-UP
TLK-PRO	MULCHER FÜR FRONT- UND HECKANBAU: AUSFÜHRUNG MIT PICK-UP
TLK-PRO	TRITURADORA REVERSIBLE A CUCHILLAS - CON ALIMENTACIÓN PICK-UP
TLK-PRO	BROYEUR RÉVERSIBLE HORS SOL À FLÉAUX AVEC ALIMENTATION PICK-UP

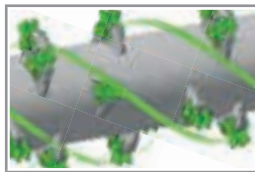
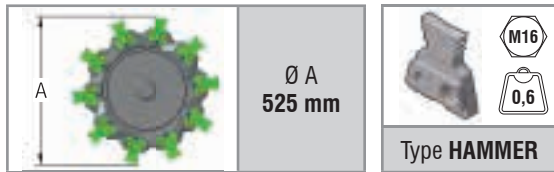

Sistema di taglio elicoidale
Helical cutting system
Spiral rotor
Sistema de corte helicoidal
Système de coupe hélicoïdal



MOD	MOVEMENT MACHINE	
mod.	cm	
TLK-PRO 1300	73	88
TLK-PRO 1550	90	95
TLK-PRO 1800	102	108

WORKING WIDTH	Standard	On request
cm	nr	nr
130	32	12
155	38	14
180	48	18



cod.	A richiesta	On request	Auf Anfrage	Opcionales	Sur demande
5130009	Cardano T-60	PTO shaft T-60	Gelenkwelle T-60	Cardán T-60	Cardan T-60
5130019	Cardano T-80	PTO shaft T-80	Gelenkwelle T-80	Cardán T-80	Cardan T-80
2051411	Spuntoni di raccolta TLK-PRO1300	Harvesting spikes TLK-PRO1300	Ripperzähne TLK-PRO1300	Púas de recogida TLK-PRO1300	Dents de ramassage TLK-PRO1300
2051412	Spuntoni di raccolta TLK-PRO1550	Harvesting spikes TLK-PRO1550	Ripperzähne TLK-PRO1550	Púas de recogida TLK-PRO1550	Dents de ramassage TLK-PRO1550
2051413	Spuntoni di raccolta TLK-PRO1800	Harvesting spikes TLK-PRO1800	Ripperzähne TLK-PRO1800	Púas de recogida TLK-PRO1800	Dents de ramassage TLK-PRO1800
2050878	Secondo arco con attacco a tre punti	Second 3-point linkage	Zweiter Dreipunkbock	Arco de tercer punto posterior opcional	Deuxième arc d'attelage 3 points
2050889	Kit ruote in gomma fisse	Fixed rubber wheels kit	Satz feste Gummiräder	Kit de ruedas en goma, fijas	Kit roues fixes en caoutchouc
2050490	Kit ruote in gomma pivotanti	Pivoting rubber wheels kit	Satz schwenkbare Gummiräder	Kit de ruedas en goma, pivotantes	Kit roues pivotantes en caoutchouc
2050517	Rullo ozioso TLK-PRO 1300	Levelling roller TLK-PRO 1300	Hintere Stützwalze TLK-PRO 1300	Rodillo nivelador TLK-PRO 1300	Rouleau d'appui TLK-PRO 1300
2050518	Rullo ozioso TLK-PRO 1550	Levelling roller TLK-PRO 1550	Hintere Stützwalze TLK-PRO 1550	Rodillo nivelador TLK-PRO 1550	Rouleau d'appui TLK-PRO 1550
2050519	Rullo ozioso TLK-PRO 1800	Levelling roller TLK-PRO 1800	Hintere Stützwalze TLK-PRO 1800	Rodillo nivelador TLK-PRO 1800	Rouleau d'appui TLK-PRO 1800

cod.	Ricambi	Spare parts	Ersatzteile	Recambios	Pièces de rechange
5354090	Cinghia SPB 1650	Cug belt SPB 1650	Keilriemen SPB 1650	Correa SPB 1650	Courroie SPB 1650
3233133	Martello rompitore	Hammer	Hammer	Martillo	Marteau
5023086	Motore idraulico	Hydraulic motor	Hydraulikmotor	Motor hidraulico	Moteur hydraulique
2020140	Scatola tras. TLK-PRO 1300	Gear box TLK-PRO 1300	Getriebe TLK-PRO 1300	Caja de eng. TLK-PRO 1300	Boîtier de transm. TLK-PRO 1300
2020139	Scatola tras. TLK-PRO 1550	Gear box TLK-PRO 1550	Getriebe TLK-PRO 1550	Caja de eng. TLK-PRO 1550	Boîtier de transm. TLK-PRO 1550
2020138	Scatola tras. TLK-PRO 1800	Gear box TLK-PRO 1800	Getriebe TLK-PRO 1800	Caja de eng. TLK-PRO 1800	Boîtier de transm. TLK-PRO 1800

cod. 2050889
On request
Kit ruote in gomma fisse
Fixed rubber wheels kit
Satz feste Gummiräder
Kit de ruedas en goma, fijas
Kit roues fixes en caoutchouc



cod. 2050490
On request
Kit ruote in gomma pivotanti
Pivoting rubber wheels kit
Satz schwenkbare Gummiräder
Kit de ruedas en goma, pivotantes
Kit roues pivotantes en caoutchouc



TLK-PRO

Impiego	Use	Verwendung	Uso	Utilisation
---------	-----	------------	-----	-------------

La trinciatrice reversibile TMK si presta in modo ottimale per la triturazione di residui di potatura e può essere utilizzata su qualsiasi terreno, anche di tipo sassoso.

The TMK reversible mulcher is ideal for shredding pruning waste and can be used over all kinds of terrain, including stony ground.

Der TMK pick-up Mulcher eignet sich ideal für die Zerkleinerung von Schnittresten und kann auf jedem, auch steinigem, Gelände eingesetzt werden.

La trituradora reversible TMK sirve para triturar de manera ideal los residuos de poda y se puede utilizar en cualquier tipo de terreno, inclusive pedregoso.

Le broyeur réversible TMK est idéal en particulier pour le broyage de résidus d'élagage et peut être utilisée sur n'importe quel terrain, y compris de type caillouteux.

Hardox
in my body

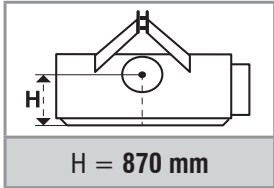

Sistema di taglio con incrocio coltello e controcoltello
Cutting blade runs into the counter-blade
Schnittsystem Messer-Gegenmesser
Sistema de corte con cruce de cuchilla y contra cuchilla
Système de coupe avec croisement couteau et contre couteau

mod.	cod.	HP	rpm/min	type	nr (type)	cm	kg
TMK 1550	1002687	90 - 150	750/(1000*)	T-80	6 (XPB 1800)	191×143×137	1350
TMK 1800	1002654	90 - 150	1000/(750*)	T-80	6 (XPB 1700)	216×143×137	1540
TMK 2100	1002655	100 - 150	1000/(750*)	T-80	6 (XPB 1700)	244×143×137	1700

* A richiesta - On request - Auf Anfrage - Opcionales - Sur demande

Nota: specificare se PTO 750 giri/min o PTO 1000 giri/min

Note: Specify PTO speed: 750 rpm or 1000 rpm.

Anmerkung: Bitte angeben, ob die Zapfwelle mit Drehzahl 750 U/min oder 1000 U/min gewünscht ist.

Nota: especificar si la toma de fuerza es de 750 r.p.m. o de 1000 r.p.m.

Note: préciser l'option PDF à 750 tours/min ou à 1000 tours/min.

Di serie	Standard equipment	Serienmässig	Estándar	De série
<ul style="list-style-type: none"> Scatola di trasmissione con doppia ruota libera PTO 1 3/8" Z6 Rotore con sistema di taglio elicoidale Castello fisso Sistema di taglio con incrocio coltello e controcoltello Slitte d'appoggio fisse Kit ruote posteriori in acciaio fisse Rullo pick up idraulico doppio Cofano apribile (solo per ispezione) Telaio con doppia lamiera Protezioni antinfortunistiche conformi alla normativa CE 	<ul style="list-style-type: none"> Gearbox with double freewheel clutch PTO 1 3/8" Z6 Rotor with helical cutting system 3-point linkage fixed Cutting system with blade and counter-blade crossing Fixed skids Fixed steel rear wheels kit Hydraulically powered double pick-up roller Opening hood (for inspection only) Double skinned frame Protective equipment as per EC safety rules 	<ul style="list-style-type: none"> Getriebe mit doppeltem Freilauf PTO 1 3/8" Z6 Spiralrotor Anbaubock fest Schneidsystem mit Messer- und Gegenmesserkreuzung Stützkufen fest Satz feste Stahl-Hinterräder Hydraulisch angetriebene Doppelaufnahmewalze Heckhaube (darf nur für Wartungsarbeiten geöffnet werden) Doppelwandiger Rahmen Unfallschutz nach EU-Vorschriften 	<ul style="list-style-type: none"> Caja de engranajes con doble rueda libre TDF 1 3/8" Z6 Rotor con sistema de corte helicoidal Arco de tercer punto fijo Sistema de corte a través del cruce de cuchilla con la contra cuchilla Patines de apoyo fijos Kit de ruedas traseras, en hierro, fijas Pick-up doble de accionamiento hidráulico Portón trasero aperturable (solo para inspección) Interior del cuerpo de maquina, con doble chapa Protecciones de seguridad de acuerdo con la norma CE 	<ul style="list-style-type: none"> Boîtier de transmission avec double roue libre PDF 1 3/8" Z6 Rotor avec système de coupe hélicoïdal Châssis fixe Système de coupe avec couteaux et contre-couteaux Patins d'appui fixes Kit roues arrière fixes en acier Double rouleau pick-up hydraulique Capot ouvrant (pour inspection seulement) Caisson renforcé par blindage interne Protections contre les accidents aux normes CE

TMK	REVERSIBLE BLADES MULCHER EXTRA-HEAVY DUTY WITH PICK-UP
TMK	MULCHER FÜR FRONT- UND HECKANBAU: AUSFÜHRUNG MIT PICK-UP
TMK	TRITURADORA REVERSIBLE EXTRA PESADA CON ALIMENTACIÓN PICK-UP
TMK	BROYEUR RÉVERSIBLE EXTRA-LOURD HORS SOL AVEC ALIMENTATION PICK-UP



ORIGINAL MADE IN ITALY

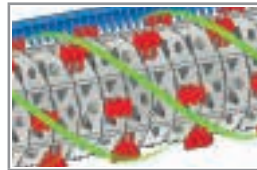
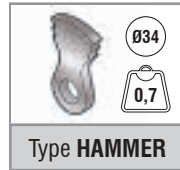
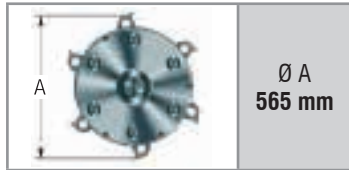

Sistema di taglio elicoidale
Helical cutting system
Spiralrotor
Sistema de corte helicoidal
Système de coupe hélicoïdal



MOVEMENT MACHINE		
MOD		
mod.	cm	
TMK 1550	91	100
TMK 1800	104	112
TMK 2100	118	126

WORKING WIDTH		Standard
cm	nr	
155	70	
180	82	
210	96	

cod.	A richiesta	On request	Auf Anfrage	Opcionales	Sur demande
5130019	Cardano T-80	PTO shaft T-80	Gelenkwelle T-80	Cardán T-80	Cardan T-80
2050889	Kit ruote in gomma fisse	Fixed rubber wheels kit	Satz feste Gummiräder	Kit de ruedas en goma, fijas	Kit roues fixes en caoutchouc
2050514	Rullo ozioso TMK 1550	Levelling roller TMK 1550	Hintere Stützwalze TMK 1550	Rodillo nivelador TMK 1550	Rouleau d'appui TMK 1550
2050515	Rullo ozioso TMK 1800	Levelling roller TMK 1800	Hintere Stützwalze TMK 1800	Rodillo nivelador TMK 1800	Rouleau d'appui TMK 1800
2050516	Rullo ozioso TMK 2100	Levelling roller TMK 2100	Hintere Stützwalze TMK 2100	Rodillo nivelador TMK 2100	Rouleau d'appui TMK 2100

cod.	Ricambi	Spare parts	Ersatzteile	Recambios	Pièces de rechange
5354068	Cinghia XPB 1700	Cug belt XPB 1700	Keilriemen XPB 1700	Correa XPB 1700	Courroie XPB 1700
5354045	Cinghia XPB 1800	Cug belt XPB 1800	Keilriemen XPB 1800	Correa XPB 1800	Courroie XPB 1800
5229407	Martello rompitorre	Hammer	Hammer	Martillo	Marteau
5023086	Motore idraulico	Hydraulic motor	Hydraulikmotor	Motor hidraulico	Moteur hydraulique
2020100	Scatola tras. TMK 1550	Gear box TMK 1550	Getriebe TMK 1550	Caja de eng. TMK 1550	Boîtier de trans. TMK 1550
2020101	Scatola tras. TMK 1800	Gear box TMK 1800	Getriebe TMK 1800	Caja de eng. TMK 1800	Boîtier de trans. TMK 1800
2020102	Scatola tras. TMK 2100	Gear box TMK 2100	Getriebe TMK 2100	Caja de eng. TMK 2100	Boîtier de trans. TMK 2100



cod. 2050889
On request
Kit ruote in gomma fisse
Fixed rubber wheels kit
Satz feste Gummiräder
Kit de ruedas en goma, fijas
Kit roues fixes en caoutchouc



TMK-PRO

Impiego **Use** **Verwendung** **Uso** **Utilisation**

La trinciatrice reversibile TMK-PRO si presta in modo ottimale per la triturazione di residui di potatura e può essere utilizzata su qualsiasi terreno, anche di tipo sassoso.

The TMK-PRO reversible mulcher is ideal for shredding pruning waste and can be used over all kinds of terrain, including stony ground.

Der TMK pick-up Mulcher eignet sich ideal für die Zerkleinerung von Schnittresten und kann auf jedem, auch steinigem, Gelände eingesetzt werden.

La trituradora reversible TMK-PRO sirve para triturar de manera ideal los residuos de poda y se puede utilizar en cualquier tipo de terreno, inclusive pedregoso.

Le broyeur réversible TMK-PRO est idéal en particulier pour le broyage de résidus d'élagage et peut être utilisée sur n'importe quel terrain, y compris de type caillouteux.

Hardox
in my body

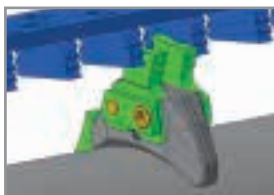
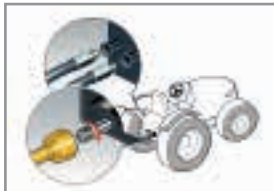
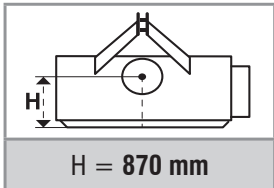

Sistema di taglio con incrocio coltello e controcoltello
Cutting blade runs into the counter-blade
Schnittsystem Messer-Gegenmesser
Sistema de corte con cruce de cuchilla y contra cuchilla
Système de coupe avec croisement couteau et contre couteau

NEW

mod.	cod.	HP	rpm/min	type	nr (type)	cm	kg
TMK-PRO 1550	1003301	90 - 150	750/(1000*)	T-80	6 (XPB 1800)	191×143×137	1250
TMK-PRO 1800	1003302	90 - 150	1000/(750*)	T-80	6 (XPB 1700)	216×143×137	1440
TMK-PRO 2100	1003303	100 - 150	1000/(750*)	T-80	6 (XPB 1700)	244×143×137	1600

* A richiesta - On request - Auf Anfrage - Opcionales - Sur demande

Nota: specificare se PTO 750 giri/min o PTO 1000 giri/min

Note: Specify PTO speed: 750 rpm or 1000 rpm.

Anmerkung: Bitte angeben, ob die Zapfwelle mit Drehzahl 750 U/min oder 1000 U/min gewünscht ist.

Nota: especificar si la toma de fuerza es de 750 r.p.m. o de 1000 r.p.m.

Note: préciser l'option PDF à 750 tours/min ou à 1000 tours/min.

Di serie	Standard equipment	Serienmässig	Estándar	De série
<ul style="list-style-type: none"> Scatola di trasmissione con doppia ruota libera PTO 1 3/8" Z6 Rotore con sistema di taglio elicoidale Castello fisso Sistema di taglio con incrocio coltello e controcoltello Slitte d'appoggio fisse Kit ruote posteriori in acciaio fisse Rullo pick up idraulico doppio Cofano apribile (solo per ispezione) Telaio con doppia lamiera Protezioni antinfortunistiche conformi alla normativa CE 	<ul style="list-style-type: none"> Gearbox with double freewheel clutch PTO 1 3/8" Z6 Rotor with helical cutting system 3-point linkage fixed Cutting system with blade and counter-blade crossing Fixed skids Fixed steel rear wheels kit Hydraulically powered double pick-up roller Opening hood (for inspection only) Double skinned frame Protective equipment as per EC safety rules 	<ul style="list-style-type: none"> Getriebe mit doppeltem Freilauf PTO 1 3/8" Z6 Spiralrotor Anbaubock fest Schneidsystem mit Messer- und Gegenmesserkreuzung Stützkufen fest Satz feste Stahl-Hinterräder Hydraulisch angetriebene Doppelaufnahmewalze Heckhaube (darf nur für Wartungsarbeiten geöffnet werden) Doppelwandiger Rahmen Unfallschutz nach EU-Vorschriften 	<ul style="list-style-type: none"> Caja de engranajes con doble rueda libre TDF 1 3/8" Z6 Rotor con sistema de corte helicoidal Arco de tercer punto fijo Sistema de corte a través del cruce de cuchilla con la contra cuchilla Patines de apoyo fijos Kit de ruedas traseras, en hierro, fijas Pick-up doble de accionamiento hidráulico Portón trasero aperturable (solo para inspección) Interior del cuerpo de maquina, con doble chapa Protecciones de seguridad de acuerdo con la norma CE 	<ul style="list-style-type: none"> Boîtier de transmission avec double roue libre PDF 1 3/8" Z6 Rotor avec système de coupe hélicoïdal Châssis fixe Système de coupe avec couteaux et contre-couteaux Patins d'appui fixes Kit roues arrière fixes en acier Double rouleau pick-up hydraulique Capot ouvrant (pour inspection seulement) Caisson renforcé par blindage interne Protections contre les accidents aux normes CE

TMK-PRO	REVERSIBLE BLADES MULCHER EXTRA-HEAVY DUTY WITH PICK-UP
TMK-PRO	MULCHER FÜR FRONT- UND HECKANBAU: AUSFÜHRUNG MIT PICK-UP
TMK-PRO	TRITURADORA REVERSIBLE EXTRA PESADA CON ALIMENTACIÓN PICK-UP
TMK-PRO	BROYEUR RÉVERSIBLE EXTRA-LOURD HORS SOL AVEC ALIMENTATION PICK-UP



ORIGINAL MADE IN ITALY

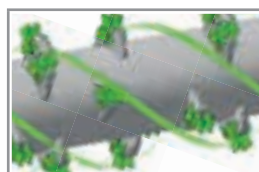
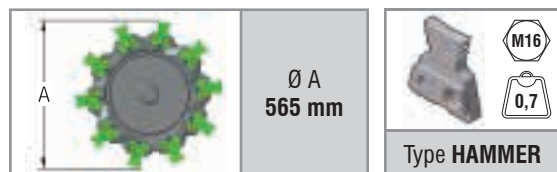

Sistema di taglio elicoidale
Helical cutting system
Spiralrotor
Sistema de corte helicoidal
Système de coupe hélicoïdal

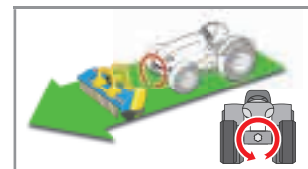
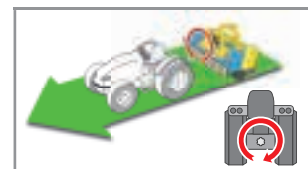

TMK-PRO

MOVEMENT MACHINE	
MOD	
mod.	cm
TMK-PRO 1550	91
TMK-PRO 1800	104
TMK-PRO 2100	118

WORKING WIDTH	
cm	nr
155	36
180	42
210	48

cod.	A richiesta	On request	Auf Anfrage	Opcionales	Sur demande
5130019	Cardano T-80	PTO shaft T-80	Gelenkwelle T-80	Cardán T-80	Cardan T-80
2050889	Kit ruote in gomma fisse	Fixed rubber wheels kit	Satz feste Gummiräder	Kit de ruedas en goma, fijas	Kit roues fixes en caoutchouc
2050514	Rullo ozioso TMK-PRO 1550	Levelling roller TMK-PRO 1550	Hintere Stützwalze TMK-PRO 1550	Rodillo nivelador TMK-PRO 1550	Rouleau d'appui TMK-PRO 1550
2050515	Rullo ozioso TMK-PRO 1800	Levelling roller TMK-PRO 1800	Hintere Stützwalze TMK-PRO 1800	Rodillo nivelador TMK-PRO 1800	Rouleau d'appui TMK-PRO 1800
2050516	Rullo ozioso TMK-PRO 2100	Levelling roller TMK-PRO 2100	Hintere Stützwalze TMK-PRO 2100	Rodillo nivelador TMK-PRO 2100	Rouleau d'appui TMK-PRO 2100

cod.	Ricambi	Spare parts	Ersatzteile	Recambios	Pièces de rechange
5354068	Cinghia XPB 1700	Cug belt XPB 1700	Keilriemen XPB 1700	Correa XPB 1700	Courroie XPB 1700
5354045	Cinghia XPB 1800	Cug belt XPB 1800	Keilriemen XPB 1800	Correa XPB 1800	Courroie XPB 1800
3232953	Martello rompitorre	Hammer	Hammer	Martillo	Marteau
5023086	Motore idraulico	Hydraulic motor	Hydraulikmotor	Motor hidraulico	Moteur hydraulique
2020100	Scatola tras. TMK-PRO 1550	Gear box TMK-PRO 1550	Getriebe TMK-PRO 1550	Caja de eng. TMK-PRO 1550	Boîtier de trans. TMK-PRO 1550
2020101	Scatola tras. TMK-PRO 1800	Gear box TMK-PRO 1800	Getriebe TMK-PRO 1800	Caja de eng. TMK-PRO 1800	Boîtier de trans. TMK-PRO 1800
2020102	Scatola tras. TMK-PRO 2100	Gear box TMK-PRO 2100	Getriebe TMK-PRO 2100	Caja de eng. TMK-PRO 2100	Boîtier de trans. TMK-PRO 2100



cod. 2050889
On request
Kit ruote in gomma fisse
Fixed rubber wheels kit
Satz feste Gummiräder
Kit de ruedas en goma, fijas
Kit roues fixes en caoutchouc



Impiego Use Verwendung Uso Utilisation

La trinciatrice reversibile TPK si presta in modo ottimale per la triturazione di residui di potatura e può essere utilizzata su qualsiasi terreno, anche di tipo sassoso. Grazie al rotore di notevoli dimensioni ed al pick-up superiore adattabile si riescono a triturare grandi volumi di potatura.

The TPK reversible mulcher is ideal for shredding pruning waste and can be used over all kinds of terrain, including stony ground. Thanks to the large rotor and the adaptable upper pick-up, it is possible to shred large volumes of prunings.

Der TMK pick-up Mulcher eignet sich ideal für die Zerkleinerung von Schnittresten und kann auf jedem, auch steinigem, Gelände eingesetzt werden.

La trituradora reversible TPK sirve para triturar de manera ideal los residuos de poda y se puede utilizar en cualquier tipo de terreno, inclusive pedregoso. Gracias al gran rotor y al pick-up superior adaptable, es posible triturar grandes volúmenes de poda.

Le broyeur réversible TPK est idéal en particulier pour le broyage de résidus d'élagage et peut être utilisée sur n'importe quel terrain, y compris de type caillouteux.

Hardox
in my body



NEW

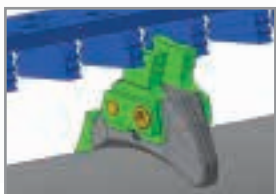

Sistema di taglio con incrocio coltello e controcoltello
Cutting blade runs into the counter-blade
Schnittsystem Messer-Gegenmesser
Sistema de corte con cruce de cuchilla y contra cuchilla
Système de coupe avec croisement couteau et contre couteau

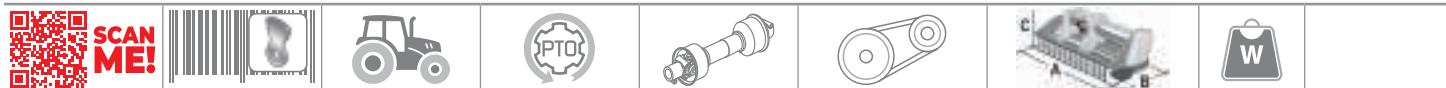
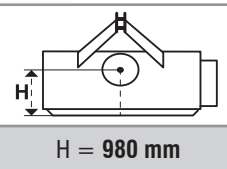

mod.	cod.	HP	rpm/min	type	nr (type)	cm	kg
TPK 1800	1003848	120 - 180	1000	T-90	6 (XPB 1850)	224×134×145	1750
TPK 2100	1003847	120 - 200	1000	T-90	6 (XPB 1850)	254×134×145	1950
TPK 2400	1003846	130 - 200	1000	T-90	6 (XPB 1850)	284×134×145	2100

Di serie	Standard equipment	Serienmässig	Estándar	De série
<ul style="list-style-type: none"> Scatola di trasmissione con doppia ruota libera PTO 1 3/4" Z6 Rotore con sistema di taglio elicoidale Castello fisso Sistema di taglio con incrocio coltello e controcoltello Pick-up superiore adattabile Kit ruote posteriori in acciaio fisse Rullo pick up idraulico doppio Cofano apribile (solo per ispezione) Telaio con doppia lamiera Protezioni antinfortunistiche conformi alla normativa CE 	<ul style="list-style-type: none"> Gearbox with double freewheel clutch PTO 1 3/4" Z6 Rotor with helical cutting system 3-point linkage fixed Cutting system with blade and counter-blade crossing Adaptable upper pick-up Fixed steel rear wheels kit Hydraulically powered double pick-up roller Opening hood (for inspection only) Double skinned frame Protective equipment as per EC safety rules 	<ul style="list-style-type: none"> Getriebe mit doppeltem Freilauf PTO 1 3/4" Z6 Spiralrotor Anbaubock fest Schneidsystem mit Messer- und Gegenmesserkreuzung Anpassbarer oberer Doppelaufnahmewalze Satz feste Stahl-Hinterräder Hydraulisch angetriebene Doppelaufnahmewalze Heckhaube (darf nur für Wartungsarbeiten geöffnet werden) Doppelwandiger Rahmen Unfallschutz nach EU-Vorschriften 	<ul style="list-style-type: none"> Caja de engranajes con doble rueda libre TDF 1 3/4" Z6 Rotor con sistema de corte helicoidal Arco de tercer punto fijo Sistema de corte a través del cruce de cuchilla con la contra cuchilla Pick-up superior adaptable Kit de ruedas traseras, en hierro, fijas Pick-up doble de accionamiento hidráulico Portón trasero aperturable (solo para inspección) Interior del cuerpo de maquina, con doble chapa Protecciones de seguridad de acuerdo con la norma CE 	<ul style="list-style-type: none"> Boîtier de transmission avec double roue libre PDF 1 3/4" Z6 Rotor avec système de coupe hélicoïdal Châssis fixe Système de coupe avec couteaux et contre-couteaux Pick-up supérieur adaptable Kit roues arrière fixes en acier Double rouleau pick-up hydraulique Capot ouvrant (pour inspection seulement) Caisson renforcé par blindage interne Protections contre les accidents aux normes CE

TPK	REAR/FRONT MULCHER EXTRA-HEAVY DUTY WITH PICK-UP
TPK	MULCHER FÜR FRONT- UND HECKANBAU: AUSFÜHRUNG MIT PICK-UP
TPK	TRITURADORA FRONTAL Y TRASERA EXTRA PESADA CON ALIMENTACIÓN PICK-UP
TPK	BROYEUR AVANT ET ARRIÈRE: VERSION PICK-UP EXTRA-LOURD



ORIGINAL MADE IN ITALY

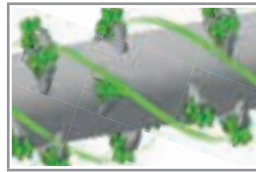
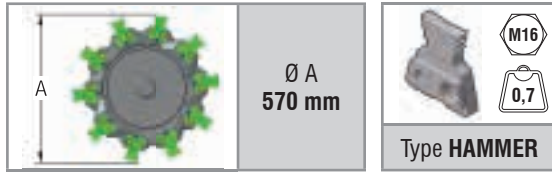

Sistema di taglio elicoidale
Helical cutting system
Spiralrotor
Sistema de corte helicoidal
Système de coupe hélicoïdal



	MOVEMENT MACHINE	
MOD		
mod.	cm	
TPK 1800	112	112
TPK 2100	127	127
TPK 2400	142	142

WORKING WIDTH	Standard	
cm	nr	
180	44	
210	52	
240	60	



cod.	A richiesta	On request	Auf Anfrage	Opcionales	Sur demande
5130056	Cardano T-90 1-3/4"+1-3/4"	PTO shaft T-90 1-3/4"+1-3/4"	Gelenkwelle T-90 1-3/4"+1-3/4"	Cardán T-90 1-3/4"+1-3/4"	Cardan T-90 1-3/4"+1-3/4"
5130083	Cardano T-90 1-3/4"+1-3/8"	PTO shaft T-90 1-3/4"+1-3/8"	Gelenkwelle T-90 1-3/4"+1-3/8"	Cardán T-90 1-3/4"+1-3/8"	Cardan T-90 1-3/4"+1-3/8"
5411050	Ruota in gomma (1 pz)	Rubber wheel (1 pc)	Gummiräder (1 Stück)	Rueda de goma (1 pz)	Roue en caoutchouc (1 pc)

cod.	Ricambi	Spare parts	Ersatzteile	Recambios	Pièces de rechange
5354098	Cinghia XPB 1850	Cug belt XPB 1850	Keilriemen XPB 1850	Correa XPB 1850	Courroie XPB 1850
3232953	Martello rompitor	Hammer	Hammer	Martillo	Marteau
5231144	Motore idraulico inferiore	Lower hydraulic motor	Unterer Hydraulikmotor	Motor hidráulico inferior	Moteur hydraulique inférieur
2020187	Scatola tras. TPK 1800	Gear box TPK 1800	Getriebe TPK 1800	Caja de eng. TPK 1800	Boîtier de trans. TPK 1800
2020188	Scatola tras. TPK 2100	Gear box TPK 2100	Getriebe TPK 2100	Caja de eng. TPK 2100	Boîtier de trans. TPK 2100
2020189	Scatola tras. TPK 2400	Gear box TPK 2400	Getriebe TPK 2400	Caja de eng. TPK 2400	Boîtier de trans. TPK 2400



On request
Kit ruote in gomma
Rubber wheels kit
Satz Gummiräder
Kit de ruedas en goma
Kit roues en caoutchouc



Impiego	Use	Verwendung	Uso	Utilisation
---------	-----	------------	-----	-------------

La trinciaerba e sarmenti TLP si presta in modo ottimale alla pulizia dai residui di potatura e arbusti in genere in colture a fusto e fronde basse come frutteti, uliveti e vigneti. È ideale anche per la triturazione di sarmenti, mais, erba, sterpaglie, paglia, piantagioni in genere, e molto altro.

TLP mulcher it's ideal for general purpose shrub and pruning waste mulching in low foliage stem crops, orchards, olive groves and vineyards. It is ideal for mulching grass, maize, hay, pruning waste (in olive groves, orchards, etc.), brushwood and more besides.

Das TLP-Mulchergerät ist ideal für das Zerkleinern von Baumschnittresten und Sträuchern in Kulturen wie Obstplantagen, Olivenbäumen und Weinbergen. Er ist auch ideal zum Häckseln von Mais, Gras, Reisig, Stroh, Plantagen im Allgemeinen und vielem mehr.

La trituradora de hierba y sarmientos TLP se presta muy bien para la limpieza de los restos de poda y arbustos en general en cultivos de árboles de follaje bajo como frutales, olivos y viñedos. Es excelente para la trituración de hierba, maíz, paja, residuos de poda (en olivares, frutales, etc.), malezas y mucho más.

Le broyeur d'herbe et de sarments TLP, est particulièrement indiqué pour le nettoyage des déchets d'élagage et d'arbustes en général dans les cultures avec tronc et frondaisons basses comme les vergers, les oliveraies et les vignes. Il est particulièrement indiqué pour le broyage d'herbe, maïs, paille, déchets d'élagage (dans les oliveraies, les vergers, etc.), de broussailles et autres végétaux.

Carter arrotondato
Rounded belts cover
Mit gerundeter Keilriemenschutz
Carter redondeado
Carter arrondi



Doppia fila catene antiurto
Double Internal chain shock absorbing
Dopple Innkettenvorhang
Doble Cadena de protección delantera
Double Chaîne antichocs

mod.	cod.	HP	rpm/min	type	nr (type)	cm	kg
TLP 1650	1003836	50 - 100	540/1000	T-60	4 (XPB 1600)	191×128×90	768
TLP 1850	1003837	60 - 100	540/1000	T-60	5 (XPB 1600)	212×128×90	825
TLP 2100	1003838	80 - 130	540/1000	T-70	5 (XPB 1600)	233×128×90	885

Di serie	Standard equipment	Serienmässig	Estándar	De série
<ul style="list-style-type: none"> Scatola di trasmissione con ruota libera PTO 1 3/8" Z6 Rotore con sistema di taglio lineare Spostamento su barre cromate Spostamento laterale meccanico Tripla fila di pettini rompitori Slitte d'appoggio regolabili in altezza Carter arrotondato Rullo ozioso posteriore (229 mm) Raschiafango per pulizia rullo ozioso Cofano apribile idraulicamente Telaio con doppia lamiera Protezione anteriore a bandinelle e doppia fila di catene Protezioni antinfortunistiche conformi alla normativa CE 	<ul style="list-style-type: none"> Gearbox with freewheel clutch PTO 1 3/8" Z6 Rotor with linear cutting system Side shift on chrome bars Mechanical side shift Triple row counter-blades Height-adjustable skids Rounded belt guard Rear levelling roller (229 mm) Scraper for rear levelling roller Hydraulic adjustment of the rear hood Double skinned frame Front protection with metal flaps and double row chains Protective equipment as per EC safety rules 	<ul style="list-style-type: none"> Getriebe mit integriertem Freilauf PTO 1 3/8" Z6 Rotor mit linear Schnittsystem Seitenverschiebung über Chromstangen Mechanische Seitenverschiebung 3 Reihen Gegenschneide Höhenverstellbare Stützkufen Abgerundeter Keilriemenschutz Hintere Stützwalze (229 mm) Walzenabstreifer Hydraulische Verstellung der Heckhaube Doppelwandiger Rahmen Frontschutz mit Metallklappen und doppelreihigen Ketten Unfallschutz nach EU-Vorschriften 	<ul style="list-style-type: none"> Caja de engranajes con rueda libre TDF 1 3/8" Z6 Rotor con sistema de corte lineal Desplazamiento sobre tubo cromado Desplazamiento lateral mecánico Triple fila de rompedores Patines de apoyo reg. en altura Carter redondeado Rodillo nivelador trasero (229 mm) Limpiador montado en el rodillo nivelador trasero Portón trasero con apertura hidr. Interior del cuerpo de maquina, con doble chapa Protección delantera a placas metálicas y doble fila de cadenas Protecciones de seguridad de acuerdo con la norma CE 	<ul style="list-style-type: none"> Boîtier de transmission avec roue libre PDF 1 3/8" Z6 Rotor avec système de coupe linéaire Déplacement avec barre chromée Déport latéral mécanique Triple rangée de peignes Patins d'appui réglables en hauteur Carter arrondi Rouleau d'appui arrière (229 mm) Racleur pour le rouleau d'appui Capot à ouverture hydraulique Caisson renforcé par blindage interne Protection avant avec volets métalliques et double rangée de chaînes Protections contre les accidents aux normes CE

TLP	SEMIFOREST MULCHER HEAVY DUTY
TLP	MULCHGERÄTE: SCHWERE AUSFÜHRUNG
TLP	TRITURADORA DE HIERBA Y SARMIENTOS PESADA
TLP	BROYEUR D'HERBE ET DE SARMENTS



ORIGINAL MADE IN ITALY

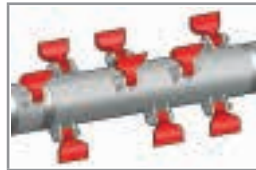
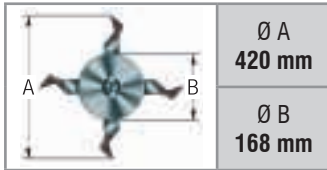

Sistema di taglio lineare
Linear cutting system
Linearrotor
Sistema de corte lineal
Système de coupe linéaire

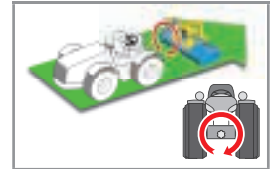

MOD	MOVEMENT MACHINE					WORKING WIDTH	Standard
	cm		cm		cm		
TLP 1650	116	75	76	115	40	165	14
TLP 1850	133	79	93	119	40	185	16
TLP 2100	133	100	93	140	40	210	18

cod.	A richiesta	On request	Auf Anfrage	Opcionales	Sur demande
5130009	Cardano T-60	PTO shaft T-60	Gelenkwelle T-60	Cardán T-60	Cardan T-60
5130010	Cardano T-70	PTO shaft T-70	Gelenkwelle T-70	Cardán T-70	Cardan T-70
2050011	Gruppo spost. idr. 40 cm	Hydraulic side shift 40 cm	Hydraulische Verschiebung 40 cm	Kit desplazador hidr. 40 cm	Groupe de dépl. lat. 40 cm

cod.	Ricambi	Spare parts	Ersatzteile	Recambios	Pièces de rechange
5354067	Cinghia XPB-1600	Cug belt XPB-1600	Keilriemen XPB-1600	Correa XPB-1600	Courroie XPB-1600
5315093	Vite M20 per utensile	M20 screw for tool	M20 Schraube für Werkzeug	Tornillo M20 para herramienta	Vis M20 pour outil
5323018	Dado M20 per utensile	M20 nut for tool	M20 Mutter für Werkzeug	Tuerca M20 para herramienta	Ecrou M20 pour outil
5350038	Mazza RM.10	Hammer RM.10	Hammer RM.10	Martillo RM.10	Marteau RM.10
2020035	Sc. trasm. TLP 1650	Gear box TLP 1650	Getriebe TLP 1650	Caja de engr. TLP 1650	Boîtier de transm. TLP 1650
2020036	Sc. trasm. TLP 1850/2100	Gear box TLP 1850/2100	Getriebe TLP 1850/2100	Caja de engr. TLP 1850/2100	Boîtier de transm. TLP 1850/2100

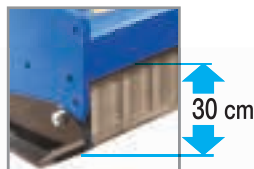
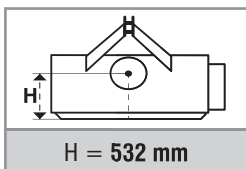

Standard equipment

Cofano apribile idraulicamente
Hydraulic adjustment of the rear hood
Hydraulische Verstellung der Heckhaube
Portón trasero con apertura hidráulica
Capot à ouverture hydraulique

Impiego Use Verwendung Uso Utilisation

La trinciherba e sarmenti TMP si presta in modo ottimale alla pulizia dai residui di potatura e arbusti in genere in colture a fusto e fronde basse come frutteti, uliveti e vigneti. È ideale anche per la triturazione di sarmenti, mais, erba, sterpaglie, paglia, piantagioni in genere, e molto altro.

The TMP flail mower is ideal for mulching general purpose shrub and pruning waste mulching in low foliage stem crops, orchards, olive groves and vineyards.

Dank seiner hydraulisch betätigten Heckhaube eignet sich das TMP Mulchgerät ideal für die Reinigung von Schnittresten mit großer Dicke und Sträuchern in Kulturen wie Obst-, Oliven- und Weingärten.

La trituradora de hierba y sarmientos TMP es muy apta para la limpieza de los residuos de poda y arbustos en general en cultivos de árboles de follaje bajo como frutales, olivos y viñedos. También es ideal para la trituración de sarmientos, maíz, hierbas, malezas, paja, plantaciones en general y mucho más.

Le broyeur d'herbe et de sarments TMP est parfait pour nettoyer les déchets d'élagage et d'arbustes des vergers, oliveraies et vignobles. Il est également prévu pour le broyage des sarments, du maïs, de l'herbe et des broussailles, de la paille, des végétaux en général et autres.

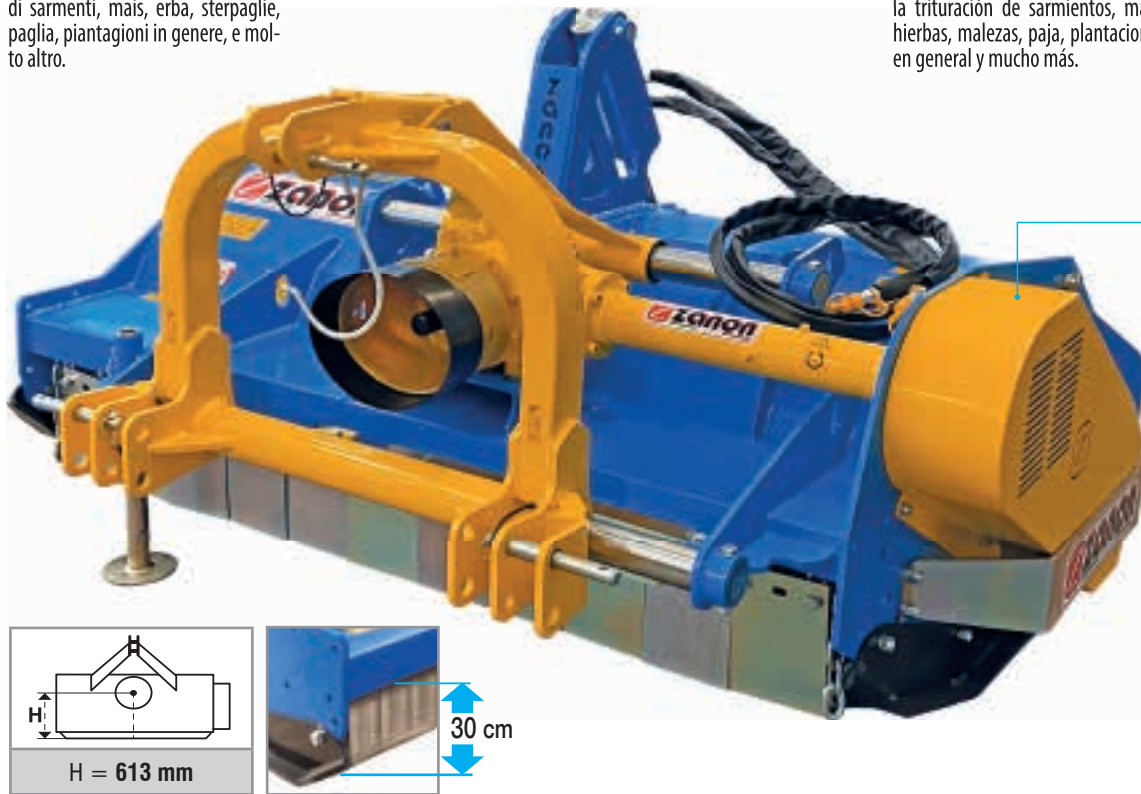

Carter arrotondato
Rounded belts cover
Mit gerundeter Keilriemenschutz
Carter redondeado
Carter arrondi

Doppia fila catene antiurto
Double Internal chain shock absorbing
Doble Innekettenvorhang
Doble Cadena de protección delantera
Double Chaîne antichocs

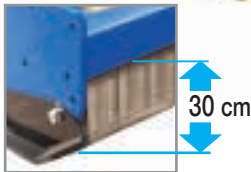
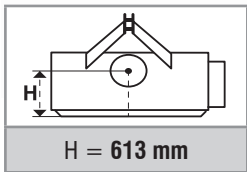

mod.	cod.	HP	rpm/min	type	nr (type)	cm	kg
TMP 1550	1002891	50 - 130	540/1000	T-60	4 (XPB 1690)	182×156×106	945
TMP 1850	1002892	60 - 130	540/1000	T-60	5 (XPB 1690)	207×156×106	1015
TMP 2050	1002893	70 - 130	540/1000	T-70	5 (XPB 1690)	231×156×106	1100
TMP 2300	1002972	80 - 130	540/1000	T-70	5 (XPB 1690)	267×156×106	1190

Di serie	Standard equipment	Serienmässig	Estándar	De série
<ul style="list-style-type: none"> Scatola di trasmissione con ruota libera PTO 1 3/8" Z6 Rotore con sistema di taglio lineare Spostamento su barre cromate Spostamento laterale meccanico Tripla fila di pettini rompitori Slitte d'appoggio regolabili in altezza Carter arrotondato Rullo ozioso posteriore (229 mm) Raschifango per pulizia rullo ozioso Cofano apribile idraulicamente Telaio con doppia lamiera Protezione anteriore a bandinelle e doppia fila di catene Protezioni antinfortunistiche conformi alla normativa CE 	<ul style="list-style-type: none"> Gearbox with freewheel clutch PTO 1 3/8" Z6 Rotor with linear cutting system Side shift on chrome bars Mechanical side shift Triple row counter-blades Height-adjustable skids Rounded belt guard Rear levelling roller (229 mm) Scraper for rear levelling roller Hydraulic adjustment of the rear hood Double skinned frame Front protection with metal flaps and double row chains Protective equipment as per EC safety rules 	<ul style="list-style-type: none"> Getriebe mit integriertem Freilauf PTO 1 3/8" Z6 Rotor mit linear Schnittsystem Seitenverschiebung über Chromstangen Mechanische Seitenverschiebung 3 Reihen Gegenschneide Höhenverstellbare Stützkufen Abgerundeter Keilriemenschutz Hintere Stützwalze (229 mm) Walzenabstreifer Hydraulische Verstellung der Heckhaube Doppelwandiger Rahmen Frontschutz mit Metallklappen und doppelreihigen Ketten Unfallschutz nach EU-Vorschriften 	<ul style="list-style-type: none"> Caja de engranajes con rueda libre TDF 1 3/8" Z6 Rotor con sistema de corte lineal Desplazamiento sobre tubo cromado Desplazamiento lateral mecánico Triple fila de rompedores Patines de apoyo reg. en altura Carter redondeado Rodillo nivelador trasero (229 mm) Limpiador montado en el rodillo nivelador trasero Portón trasero con apertura hidr. Interior del cuerpo de maquina, con doble chapa Protección delantera a placas metálicas y doble fila de cadenas Protecciones de seguridad de acuerdo con la norma CE 	<ul style="list-style-type: none"> Boîtier de transmission avec roue libre PDF 1 3/8" Z6 Rotor avec système de coupe linéaire Déport latéral mécanique Triple rangée de peignes Patins d'appui réglables en hauteur Carter arrondi Rouleau d'appui arrière (229 mm) Racleur pour le rouleau d'appui Capot à ouverture hydraulique Caisson renforcé par blindage interne Protection avant avec volets métalliques et double rangée de chaînes Protections contre les accidents aux normes CE

TMP	SEMIFOREST MULCHER EXTRA HEAVY DUTY
TMP	MULCHGERÄTE: EXTRASCHWERE AUSFÜHRUNG
TMP	TRITURADORA DE HIERBA Y SARMIENTOS EXTRA PESADA
TMP	BROYEUR D'HERBE ET DE SARMENTS



ORIGINAL MADE IN ITALY

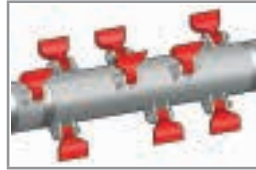
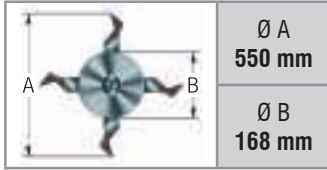

Sistema di taglio lineare
Linear cutting system
Linearrotor
Sistema de corte lineal
Système de coupe linéaire

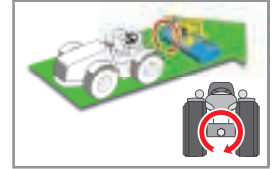

TMP

MOD	MOVEMENT MACHINE					WORKING WIDTH	Standard
	mod.	cm	cm	cm	cm	cm	nr
TMP 1550	107	75	77	105	30	155	12
TMP 1850	108	99	78	129	30	185	14
TMP 2050	130	101	90	141	40	205	16
TMP 2300	130	130	90	170	40	230	18

cod.	A richiesta	On request	Auf Anfrage	Opcionales	Sur demande
5130009	Cardano T-60	PTO shaft T-60	Gelenkwelle T-60	Cardán T-60	Cardan T-60
5130010	Cardano T-70	PTO shaft T-70	Gelenkwelle T-70	Cardán T-70	Cardan T-70
2050010	Gruppo spost. idr. 30 cm	Hydraulic side shift 30 cm	Hydraulische Verschiebung 30 cm	Kit desplazador hidr. 30 cm	Groupe de dépl. lat. 30 cm
2050011	Gruppo spost. idr. 40 cm	Hydraulic side shift 40 cm	Hydraulische Verschiebung 40 cm	Kit desplazador hidr. 40 cm	Groupe de dépl. lat. 40 cm

cod.	Ricambi	Spare parts	Ersatzteile	Recambios	Pièces de rechange
5354058	Cinghia XPB-1690	Cug belt XPB-1690	Keilriemen XPB-1690	Correa XPB-1690	Courroie XPB-1690
5315550	Vite M20 per utensile	M20 screw for tool	M20 Schraube für Werkzeug	Tornillo M20 para herramienta	Vis M20 pour outil
5323018	Dado M20 per utensile	M20 nut for tool	M20 Mutter für Werkzeug	Tuerca M20 para herramienta	Ecrou M20 pour outil
5350098	Mazza RM.69	Hammer RM.69	Hammer RM.69	Martillo RM.69	Marteau RM.69
2020035	Sc. trasm. TMP 1550/1850	Gear box TMP 1550/1850	Getriebe TMP 1550/1850	Caja de engr. TMP 1550/1850	Boîtier de transm. TMP 1550/1850
2020036	Sc. trasm. TMP 2050	Gear box TMP 2050	Getriebe TMP 2050	Caja de engr. TMP 2050	Boîtier de transm. TMP 2050



Standard equipment

Cofano apribile idraulicamente
Hydraulic adjustment of the rear hood
Hydraulische Verstellung der Heckhaube
Portón trasero con apertura hidráulica
Capot à ouverture hydraulique

Before

After



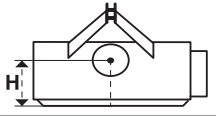

H = 660 mm

Hardox
in my body



Di serie
Standard
Serienmässig
Estándar
De série

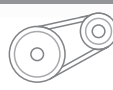
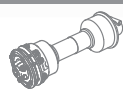

mod.	cod.	HP	rpm/min	type	nr (type)	cm	kg
TM 1200	1002759	60 - 120	1000	T-60+FR	5 (SPB 1600)	150×112×112	865
TM 1400	1002692	90 - 120	1000	T-60+FR	5 (SPB 1600)	170×112×112	1115
TM 1600	1002693	90 - 120	1000	T-60+FR	5 (SPB 1600)	192×112×112	1170
TM 1800	1002694	100 - 160	1000	T-80+FR	6 (SPB 1600)	212×112×112	1230
TM 2000	1002695	100 - 160	1000	T-80+FR	6 (SPB 1600)	234×112×112	1270
TM 2250	1002758	120 - 160	1000	T-80+FR	6 (SPB 1600)	254×112×112	1330

Supplemento per modello reversibile • Extra price for front version mulcher • Zuschlag Mulcher Frontanbau • Recargo para versión frontal • Supplément pour modèle réversible

Di serie	Standard equipment	Serienmässig	Estándar	De série
<ul style="list-style-type: none"> Scatola di trasmissione con ruota libera PTO 1 3/8" Z6 Cardano con frizione Rotore con sistema di taglio lineare Rotore forestale con mazze a scomparsa Castello fisso Doppia fila di pettini rompitori Slitte d'appoggio regolabili in altezza Pattino slitta in lamiera antiusura Cofano apribile idraulicamente Telaio con doppia lamiera Protezione anteriore a bandinelle e doppia fila di catene Protezione posteriore a catene Abbattitronco meccanico Protezioni antinfortunistiche conformi alla normativa CE 	<ul style="list-style-type: none"> Gearbox with freewheel clutch PTO 1 3/8" Z6 PTO drive shaft with friction Rotor with linear cutting system Forestry rotor with swinging hammers 3-point linkage fixed Double row counter-blades Height-adjustable skids Skids protections in anti-wearing plate Hydraulic adjustment of the rear hood Double skinned frame Front protection with metal flaps and double row chains Rear protection with chains Mechanical push frame Protective equipment as per EC safety rules 	<ul style="list-style-type: none"> Getriebe mit integriertem Freilauf PTO 1 3/8" Z6 Gelenkwelle mit Rutschkupplung Rotor mit linear Schnittsystem Forstrotor mit schwingenden Schlägel Anbaubock fest 2 Reihen Gegenschneide Höhenverstellbare Stützkufen Verschleißschutzplatten für Stützkufen Hydraulische Verstellung der Heckhaube Doppelwandiger Rahmen Frontschutz mit Metallklappen und doppelreihigen Ketten Hinterer Kettenschutz Drückvorrichtung mechanisch Unfallschutz nach EU-Vorschriften 	<ul style="list-style-type: none"> Caja de engranajes con rueda libre TDF 1 3/8" Z6 Transmisión cardanica con embrague Rotor con sistema de corte lineal Rotor forestal con martillos retráctiles Arco de tercer punto fijo Doble fila de rompedores Patines de apoyo regulable en altura Suplemento patín en acero anti desgaste Portón trasero con apertura hidráulica Interior del cuerpo de maquina, con doble chapa Protección delantera a placas metálicas y doble fila de cadenas Protección posterior a cadenas Protector de troncos mecánico Protecciones de seguridad de acuerdo con la norma CE 	<ul style="list-style-type: none"> Boîtier de transmission avec roue libre PDF 1 3/8" Z6 Cardan avec embrayage à friction Rotor avec système de coupe linéaire Rotor forestier avec marteaux escamotables Châssis fixe Double rangée de peignes Patins d'appui réglables en hauteur Plaques anti-usure Capot à ouverture hydraulique Caisson renforcé par blindage interne Protection avant avec volets métalliques et double rangée de chaînes Protection arrière avec chaînes Rabatteur de branches mécanique Protections contre les accidents aux normes CE

Impiego

La TM è adatta a trinciare ramaglia, vegetazione incolta, tronchi fino a 20 cm di diametro.

Use

The TM mulcher is designed to shred branches, vegetation and logs of up to 20 cm in diameter.

Verwendung

Der Forstmulcher TM eignet sich zum Häckseln von Pflanzen, Gestrüpp und Stämmen bis 20 cm Durchmesser

Uso

La TM es apta para triturar matorrales, vegetación no cultivada, troncos de hasta 20 cm de diámetro.

Utilisation

Le broyeur TM est adapté à broyer les branchages, la végétation sauvage, les troncs jusqu'à 20 cm de diamètre.

TM	FOREST MULCHER WITH HAMMER ROLLER
TM	FORSTMULCHER MIT BEWEGLICHEM HAMMER
TM	TRITURADORA FORESTAL CON RODILLO CON MARTILLOS
TM	BROYEUR FORESTIER AVEC ROULEAU À MARTEAUX



ORIGINAL MADE IN ITALY

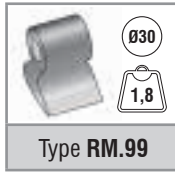
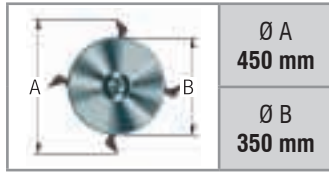

Sistema di taglio lineare
Linear cutting system
Linearroter
Sistema de corte lineal
Système de coupe linéaire

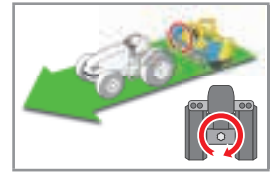

	WORKING WIDTH	CUTTING	Standard
MOD			
mod.	cm	cm	nr
TM 1200	120	20	20
TM 1400	140	20	24
TM 1600	160	20	28
TM 1800	180	20	32
TM 2000	200	20	36
TM 2250	225	20	40



Portellone con comando idraulico di serie
Hydraulic door as standard feature
Hydraulische einstellbare Heckklappe Serienmäßig
Puerta trasera accionada hidráulicamente, de serie
Portillon avec commande hydraulique de série

Descrizioni, dati e foto sono indicative e possono anche riguardare attrezzature non di serie fornibili a richiesta.

All descriptions, specifications and pictures in this brochure should be considered approximate and may include optional equipment that is not part of the standard specifications.

Angaben und Abbildungen sind als annähernd zu betrachten und können auch nicht zum serienmäßigen Lieferumfang gehörende Sonderausstattungen enthalten.

Las indicaciones y las imágenes deben considerarse aproximadas y pueden contener equipos especiales que no forman parte del suministro de serie.

Les descriptions, les caractéristiques techniques et les photos ont un but purement indicatif et peuvent également concerner des équipements non de série, mais fournis que sur demande.

cod.	Ricambi	Spare parts	Ersatzteile	Recambios	Pièces de rechange
5130047	Cardano T-60+FR	PTO shaft T-60+FR	Gelenkwelle T-60+FR	Cardán T-60+FR	Cardan T-60+FR
5130034	Cardano T-80+FR	PTO shaft T-80+FR	Gelenkwelle T-80+FR	Cardán T-80+FR	Cardan T-80+FR
5354067	Cinghia SPB-1600	Cug belt SPB-1600	Keilriemen SPB-1600	Correa SPB-1600	Courroie SPB-1600
5350135	Mazza RM.99	Hammer RM.99	Hammer RM.99	Martillo RM.99	Marteau RM.99
2020034	Sc. trasm. TM 1200/1400	Gear box TM 1200/1400	Getriebe TM 1200/1400	Caja de engr. TM 1200/1400	Boîtier de transm. TM 1200/1400
2020035	Sc. trasm. TM 1600	Gear box TM 1600	Getriebe TM 1600	Caja de engr. TM 1600	Boîtier de transm. TM 1600
2020107	Sc. trasm. TM 1800/2000	Gear box TM 1800/2000	Getriebe TM 1800/2000	Caja de engr. TM 1800/2000	Boîtier de transm. TM 1800/2000
2020119	Sc. trasm. TM 2250	Gear box TM 2250	Getriebe TM 2250	Caja de engr. TM 2250	Boîtier de transm. TM 2250

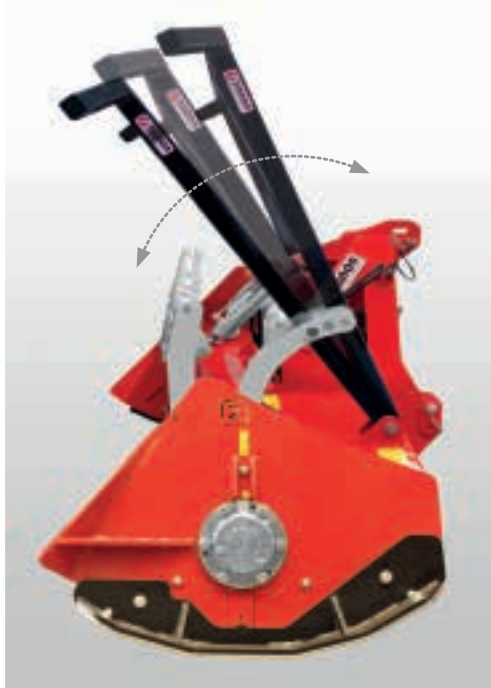

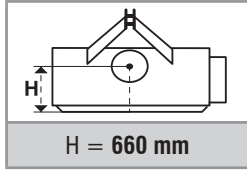

Hardox
in my body



Di serie
Standard
Serienmässig
Estándar
De série

Impiego

La TL è adatta a trinciare ramaglia, vegetazione incolta, tronchi fino a 25 cm di diametro.

Use

The TL mulcher is designed to shred branches, vegetation and logs of up to 25 cm in diameter.

Verwendung

Der Forstmulcher TL eignet sich zum Häckseln von Bäume, Pflanzen, Gestrüpp und Stämmen bis 25 cm Durchmesser.

Uso

La TL es apta para triturar matorrales, vegetación no cultivada, troncos de hasta 25 cm de diámetro.

Utilisation

Le broyeur TL est adapté à broyer les branchages, la végétation sauvage, les troncs jusqu'à 25 cm de diamètre.

mod.	cod.	HP	rpm/min	type	nr (type)	cm	kg
TL 1200	1002760	60 - 120	1000	T-60+FR	5 (SPB 1600)	150×112×112	850
TL 1400	1002688	90 - 120	1000	T-60+FR	5 (SPB 1600)	170×112×112	985
TL 1600	1002689	90 - 120	1000	T-60+FR	5 (SPB 1600)	192×112×112	1055
TL 1800	1002690	100 - 160	1000	T-80+FR	6 (SPB 1600)	212×112×112	1145
TL 2000	1002691	100 - 160	1000	T-80+FR	6 (SPB 1600)	234×112×112	1240
TL 2250	1002757	120 - 160	1000	T-80+FR	6 (SPB 1600)	254×112×112	1285

Supplemento per modello reversibile • Extra price for front version mulcher • Zuschlag Mulcher Frontanbau • Recargo para versión frontal • Supplément pour modèle réversible

Di serie	Standard equipment	Serienmässig	Estándar	De série
<ul style="list-style-type: none"> Scatola di trasmissione con ruota libera PTO 1 3/8" Z6 Cardano con frizione Rotore con sistema di taglio elicoidale Rotore forestale con inserti widia Castello fisso Doppia fila di pettini rompitori Slitte d'appoggio regolabili in altezza Pattino slitta in lamiera antiusura Cofano apribile idraulicamente Telaio con doppia lamiera Protezione anteriore a bandinelle e doppia fila di catene Protezione posteriore a catene Abbattitronco meccanico Protezioni antinfortunistiche conformi alla normativa CE 	<ul style="list-style-type: none"> Gearbox with freewheel clutch PTO 1 3/8" Z6 PTO drive shaft with friction Rotor with helical cutting system Forestry rotor with widia inserts 3-point linkage fixed Double row counter-blades Height-adjustable skids Skids protections in anti-wearing plate Hydraulic adjustment of the rear hood Double skinned frame Front protection with metal flaps and double row chains Rear protection with chains Mechanical push frame Protective equipment as per EC safety rules 	<ul style="list-style-type: none"> Getriebe mit integriertem Freilauf PTO 1 3/8" Z6 Gelenkwelle mit Rutschkupplung Spiralrotor Forstrotor mit festem Werkzeuge Anbaubock fest 2 Reihen Gegenschneide Höhenverstellbare Stützkufen Verschleißschutzplatten für Stützkufen Hydraulische Verstellung der Heckhaube Doppelwandiger Rahmen Frontschutz mit Metallklappen und doppelreihigen Ketten Hinterer Kettenschutz Drückvorrichtung mechanisch Unfallschutz nach EU-Vorschriften 	<ul style="list-style-type: none"> Caja de engranajes con rueda libre TDF 1 3/8" Z6 Transmisión cardanica con embrague Rotor con sistema de corte helicoidal Rotor forestal con con insertos widia Arco de tercer punto fijo Doble fila de rompedores Patines de apoyo regulable en altura Suplemento patín en acero anti desgaste Portón trasero con apertura hidráulica Interior del cuerpo de maquina, con doble chapa Protección delantera a placas metálicas y doble fila de cadenas Protección posterior a cadenas Protector de troncos mecánico Protecciones de seguridad de acuerdo con la norma CE 	<ul style="list-style-type: none"> Boîtier de transmission avec roue libre PDF 1 3/8" Z6 Cardan avec embrayage à friction Rotor avec système de coupe hélicoïdal Rotor forestier avec marteaux fixes en widia Châssis fixe Double rangée de peignes Patins d'appui réglables en hauteur Plaques anti-usure Capot à ouverture hydraulique Caisson renforcé par blindage interne Protection avant avec volets métalliques et double rangée de chaînes Protection arrière avec chaînes Rabatteur de branches mécanique Protections contre les accidents aux normes CE

TL	FOREST MULCHER WITH WIDIA ROLLER INSERTS
TL	FORSTMULCHER MIT FESTEM WERKZEUGE
TL	TRITURADORA FORESTAL CON RODILLO CON INSERTOS WIDIA
TL	BROYEUR FORESTIER AVEC ROULEAU À MARTEAUX FIXES EN WIDIA



ORIGINAL MADE IN ITALY

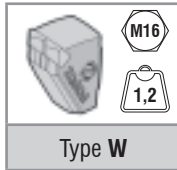
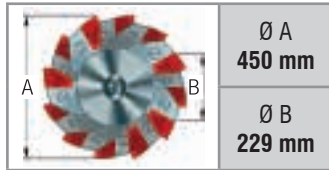

Sistema di taglio elicoidale
Helical cutting system
Spiralrotor
Sistema de corte helicoidal
Système de coupe hélicoïdal



	WORKING WIDTH	CUTTING	Standard
MOD			
mod.	cm	cm	nr
TL 1200	120	25	30
TL 1400	140	25	36
TL 1600	160	25	48
TL 1800	180	25	48
TL 2000	200	25	60
TL 2250	225	25	60



Portellone con comando idraulico di serie
Hydraulic door as standard feature
Hydraulische einstellbare Heckklappe Serienmäßig
Puerta trasera accionada hidráulicamente, de serie
Portillon avec commande hydraulique de série

Descrizioni, dati e foto sono indicative e possono anche riguardare attrezzature non di serie fornibili a richiesta.

All descriptions, specifications and pictures in this brochure should be considered approximate and may include optional equipment that is not part of the standard specifications.

Angaben und Abbildungen sind als annähernd zu betrachten und können auch nicht zum serienmäßigen Lieferumfang gehörende Sonderausstattungen enthalten.

Las indicaciones y las imágenes deben considerarse aproximadas y pueden contener equipos especiales que no forman parte del suministro de serie.

Les descriptions, les caractéristiques techniques et les photos ont un but purement indicatif et peuvent également concerner des équipements non de série, mais fournis que sur demande.

cod.	Ricambi	Spare parts	Ersatzteile	Recambios	Pièces de rechange
5130047	Cardano T-60+FR	PTO shaft T-60+FR	Gelenkwelle T-60+FR	Cardán T-60+FR	Cardan T-60+FR
5130034	Cardano T-80+FR	PTO shaft T-80+FR	Gelenkwelle T-80+FR	Cardán T-80+FR	Cardan T-80+FR
5354067	Cinghia SPB-1600	Cug belt SPB-1600	Keilriemen SPB-1600	Correa SPB-1600	Courroie SPB-1600
3231294	Dente - W	Utensils - W	Werkzeug - W	Utensillos - W	Utensils - W
2020034	Sc. trasm. TL 1200/1400	Gear box TL 1200/1400	Getriebe TL 1200/1400	Caja de engr. TL 1200/1400	Boîtier de transm. TL 1200/1400
2020035	Sc. trasm. TL 1600	Gear box TL 1600	Getriebe TL 1600	Caja de engr. TL 1600	Boîtier de transm. TL 1600
2020107	Sc. trasm. TL 1800/2000	Gear box TL 1800/2000	Getriebe TL 1800/2000	Caja de engr. TL 1800/2000	Boîtier de transm. TL 1800/2000
2020119	Sc. trasm. TL 2250	Gear box TL 2250	Getriebe TL 2250	Caja de engr. TL 2250	Boîtier de transm. TL 2250



Impiego	Use	Verwendung	Uso	Utilisation
La TF/DT SPECIAL è adatta a trinciare ramaglia, vegetazione incolta, tronchi fino a 40 cm di diametro.	The TF/DT SPECIAL mulcher is designed to shred branches, vegetation and logs of up to 40 cm in diameter.	Der Forstmulcher TF/DT SPECIAL eignet sich zum Häckseln von Bäume, Pflanzen, Gestrüpp und Stämmen bis 40 cm Durchmesser.	La TF/DT SPECIAL es apta para triturar matorrales, vegetación no cultivada, troncos de hasta 40 cm de diámetro.	Le broyeur TF/DT SPECIAL est adapté à broyer les branchages, la végétation sauvage, les troncs jusqu'à 40 cm de diamètre.

Hardox
in my body

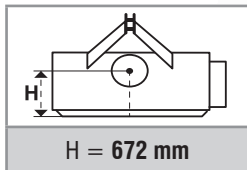
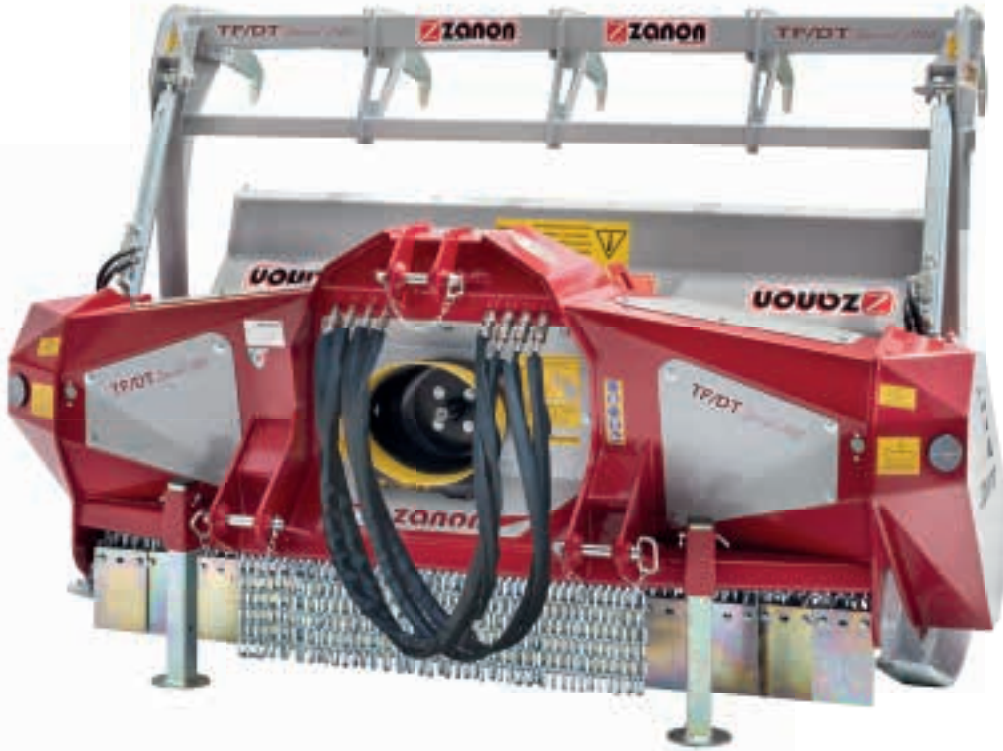

mod.	cod.	HP	rpm/min	type	nr (type)	cm	kg
TF/DT SPECIAL 2100	1002896	130 - 260	1000	T-90+FR	5+5 (SPB 2020)	250×145×120	2680*
TF/DT SPECIAL 2500	1002897	130 - 260	1000	T-90+FR	5+5 (SPB 2020)	292×145×120	2880*

* Peso completo di accessori • Full weight of accessories • Gesamtgewicht inklusiv Zubehör • Peso completo de accesorios • Poids complet avec accessoires

Di serie	Standard equipment	Serienmässig	Estándar	De série
<ul style="list-style-type: none"> Scatola di trasmissione con ruota libera PTO 1 3/4" Z6 Cardano con frizione Rotore con sistema di taglio lineare Rotore forestale con mazze a scomparsa Castello fisso Tripla fila di pettini rompitori Slitte d'appoggio regolabili in altezza Pattino slitta in lamiera antiusura Cofano apribile idraulicamente Telaio con doppia lamiera Protezione anteriore a bandinelle e doppia fila di catene Protezione posteriore a catene Abbattitronco idraulico Protezioni antinfortunistiche conformi alla normativa CE 	<ul style="list-style-type: none"> Gearbox with freewheel clutch PTO 1 3/4" Z6 PTO drive shaft with friction Rotor with linear cutting system Forestry rotor with swinging hammers 3-point linkage fixed Triple row counter-blades Height-adjustable skids Skids protections in anti-wearing plate Hydraulic adjustment of the rear hood Double skinned frame Front protection with metal flaps and double row chains Rear protection with chains Hydraulic push frame Protective equipment as per EC safety rules 	<ul style="list-style-type: none"> Getriebe mit Freilauf PTO 1 3/4" Z6 Gelenkwelle mit Rutschkupplung Rotor mit linear Schnittsystem Forstrotor mit schwingenden Schlägel Anbaubock fest 3 Reihen Gegenschneide Höhenverstellbare Stützkufen Verschleißschutzplatten für Stützkufen Hydraulische Verstellung der Heckhaube Doppelwandiger Rahmen Frontschutz mit Metallklappen und doppelreihigen Ketten Hinterer Kettenschutz Hydraulische Drückevorrichtung Unfallschutz nach EU-Vorschriften 	<ul style="list-style-type: none"> Caja de engranajes con rueda libre interna, TDF 1 3/4" Z6 Transmisión cardanica con embrague Rotor con sistema de corte lineal Rotor forestal con martillos retráctiles Arco de tercer punto fijo Triple fila de rompedores Patines de apoyo regulable en altura Suplemento patín en acero anti desgaste Portón trasero con apertura hidráulica Interior del cuerpo de maquina, con doble chapa Protección delantera a placas metálicas y doble fila de cadenas Protección posterior a cadenas Protector de troncos hidráulico Protecciones de seguridad de acuerdo con la norma CE 	<ul style="list-style-type: none"> Boîtier de transmission avec roue libre PDF 1 3/8" Z6 Cardan avec embrayage à friction Rotor avec système de coupe linéaire Rotor forestier avec marteaux escamotables Châssis fixe Triple rangée de peignes Patins d'appui réglables en hauteur Plaques anti-usure Capot à ouverture hydraulique Caisson renforcé par blindage interne Protection avant avec volets métalliques et double rangée de chaînes Protection arrière avec chaînes Rabatteur de branches hydraulique Protections contre les accidents aux normes CE

TF/DT	FOREST MULCHER WITH HAMMER ROLLER
TF/DT	FORSTMULCHER SCHWERE AUSFÜHRUNG MIT BEWEGLICHEM HAMMER
TF/DT	TRITURADORA FORESTAL CON RODILLO CON MARTILLOS
TF/DT	BROYEUR FORESTIER LOURD AVEC ROULEAU À MARTEAUX



ORIGINAL MADE IN ITALY

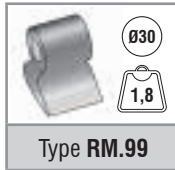
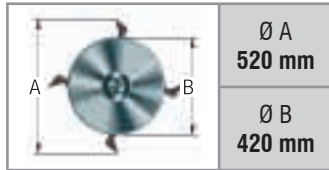

Sistema di taglio lineare
Linear cutting system
Linearroter
Sistema de corte lineal
Système de coupe linéaire

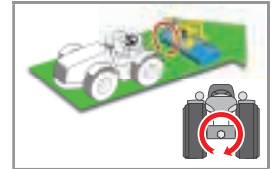

	WORKING WIDTH	CUTTING	Standard	On request
MOD				
mod.	cm	cm	nr	nr
TF/DT SPECIAL 2100	210	40	37	5
TF/DT SPECIAL 2500	250	40	45	6

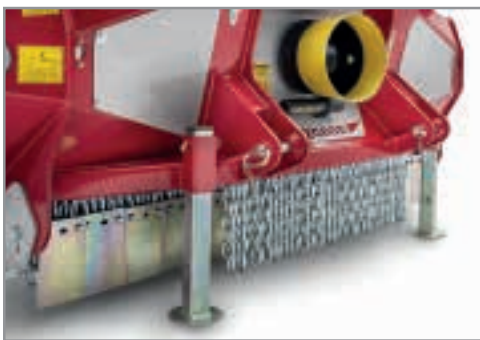

Portellone con comando idraulico e doppia fila di catene antiurto
Hydraulic door and double safety chain line
Hydraulische einstellbare Heckklappe und Doppelte Kettenreihe
Puerta trasera accionada hidráulicamente y doble fila de cadenas
Portillon avec commande hydraulique et double rangée de chaînes antichocs

Descrizioni, dati e foto sono indicative e possono anche riguardare attrezzature non di serie fornibili a richiesta.

All descriptions, specifications and pictures in this brochure should be considered approximate and may include optional equipment that is not part of the standard specifications.

Angaben und Abbildungen sind als annähernd zu betrachten und können auch nicht zum serienmäßigen Lieferumfang gehörende Sonderausstattungen enthalten.

Las indicaciones y las imágenes deben considerarse aproximadas y pueden contener equipos especiales que no forman parte del suministro de serie.

Les descriptions, les caractéristiques techniques et les photos ont un but purement indicatif et peuvent également concerner des équipements non de série, mais fournis que sur demande.

cod.	A richiesta	On request	Auf Anfrage	Opcionales	Sur demande
5223040	Spuntoni di raccolta	Pick-up teeth	Aufnahmezinken	Púas de recogida	Dents de ramassage

cod.	Ricambi	Spare parts	Ersatzteile	Recambios	Pièces de rechange
5354075	Cinghia SPB-2020	Cug belt SPB-2020	Keilriemen SPB-2020	Correa SPB-2020	Courroie SPB-2020
5350135	Mazza RM.99	Hammer RM.99	Hammer RM.99	Martillo RM.99	Marteau RM.99
5130030	Cardano T-90+FR	PTO shaft T-90+FR	Gelenkwelle T-90+FR	Cardán T-90+FR	Cardan T-90+FR
5130028	2x cardano trasm. laterale TF 2100	Double PTO connection TF 2100	Doppelter seitlicher kard. TF 2100	2x cardán trasm. lateral TF 2100	2x cardan transm. latérale TF 2100
5130029	2x cardano trasm. laterale TF 2500	Double PTO connection TF 2500	Doppelter seitlicher kard. TF 2500	2x cardán trasm. lateral TF 2500	2x cardan transm. latérale TF 2500
2020093	Scatola di trasmissione	Gear box	Getriebe	Caja de engranajes	Boîtier de transmission



Impiego **Use** **Verwendung** **Uso** **Utilisation**

La TN/DT SPECIAL è adatta a trinciare ramaglia, vegetazione incolta, tronchi fino a 40 cm di diametro.

The TN/DT SPECIAL mulcher is designed to shred branches, vegetation and logs of up to 40 cm in diameter.

Der Forstmulcher TN/DT SPECIAL eignet sich zum Häckseln von Bäume, Pflanzen, Gestrüpp und Stämmen bis 40 cm Durchmesser.

La TN/DT SPECIAL es apta para triturar matorrales, vegetación no cultivada, troncos de hasta 40 cm de diámetro.





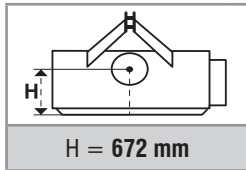

Le broyeur TN/DT SPECIAL est adapté à broyer les branchages, la végétation sauvage, les troncs jusqu'à 40 cm de diamètre.

Hardox
in my body



Di serie
Standard
Serienmässig
Estándar
De série

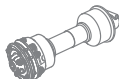
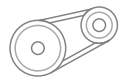

							
mod.	cod.	HP	rpm/min	type	nr (type)	cm	kg
TN/DT SPECIAL 2100	1002894	130 - 260	1000	T-90+FR	5+5 (SPB 2020)	250×145×120	2480*
TN/DT SPECIAL 2500	1002895	130 - 260	1000	T-90+FR	5+5 (SPB 2020)	292×145×120	2650*

* Peso completo di accessori • Full weight of accessories • Gesamtgewicht inklusiv Zubehör • Peso completo de accesorios • Poids complet avec accessoires

Di serie	Standard equipment	Serienmässig	Estándar	De série
<ul style="list-style-type: none"> Scatola di trasmissione con ruota libera PTO 1 3/4" Z6 Cardano con frizione Rotore con sistema di taglio elicoidale Rotore forestale con inserti in Widia Castello fisso Tripla fila di pettini rompitori Slitte d'appoggio regolabili in altezza Pattino slitta in lamiera antiusura Cofano apribile idraulicamente Telaio con doppia lamiera Protezione anteriore a bandinelle e doppia fila di catene Protezione posteriore a catene Abbattitronco idraulico Protezioni antinfortunistiche conformi alla normativa CE 	<ul style="list-style-type: none"> Gearbox with freewheel clutch PTO 1 3/4" Z6 PTO drive shaft with friction Rotor with helical cutting system Forestry rotor with fixed Widia tools 3-point linkage fixed Triple row counter-blades Height-adjustable skids Skids protections in anti-wearing plate Hydraulic adjustment of the rear hood Double skinned frame Front protection with metal flaps and double row chains Rear protection with chains Hydraulic push frame Protective equipment as per EC safety rules 	<ul style="list-style-type: none"> Getriebe mit Freilauf PTO 1 3/4" Z6 Gelenkwelle mit Rutschkupplung Spiralrotor Forstrotor mit festem Werkzeuge aus Widia Anbaubock fest 3 Reihen Gegenschneide Höhenverstellbare Stützkufen Verschleißschutzplatten für Stützkufen Hydraulische Verstellung der Heckhaube Doppelwandiger Rahmen Frontschutz mit Metallklappen und doppelreihigen Ketten Hinterer Kettenschutz Hydraulische Drückevorrichtung Unfallschutz nach EU-Vorschriften 	<ul style="list-style-type: none"> Caja de engranajes con rueda libre interna, TDF 1 3/4" Z6 Transmisión cardanica con embrague Rotor con sistema de corte helicoidal Rotor forestal con dientes fijos e insertos de Widia Arco de tercer punto fijo Triple fila de rompedores Patines de apoyo regulable en altura Suplemento patín en acero anti desgaste Portón trasero con apertura hidráulica Interior del cuerpo de maquina, con doble chapa Protección delantera a placas metálicas y doble fila de cadenas Protección posterior a cadenas Protector de troncos hidráulico Protecciones de seguridad de acuerdo con la norma CE 	<ul style="list-style-type: none"> Boîtier de transmission avec roue libre PDF 1 3/8" Z6 Cardan avec embrayage à friction Rotor avec système de coupe hélicoïdal Rotor forestier avec marteaux fixes en Widia Châssis fixe Triple rangée de peignes Patins d'appui réglables en hauteur Plaques anti-usure Capot à ouverture hydraulique Caisson renforcé par blindage interne Protection avant avec volets métalliques et double rangée de chaînes Protection arrière avec chaînes Rabatteur de branches hydraulique Protections contre les accidents aux normes CE

TN/DT	HEAVY DUTY FOREST MULCHER WITH WIDIA ROLLER INSERTS
TN/DT	FORSTMULCHER SCHWERE AUSFÜHRUNG MIT FESTEM WERKZEUGE
TN/DT	TRITURADORA FORESTAL PESADA CON RODILLO CON INSERTOS WIDIA
TN/DT	BROYEUR FORESTIER LOURD AVEC ROULEAU À MARTEAUX FIXES EN WIDIA



ORIGINAL MADE IN ITALY

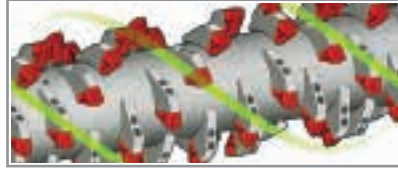
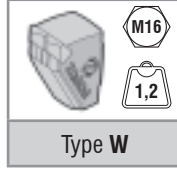
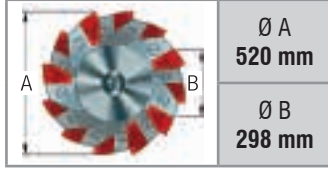

Sistema di taglio elicoidale
Helical cutting system
Spiralrotor
Sistema de corte helicoidal
Système de coupe hélicoïdal



	WORKING WIDTH	CUTTING	Standard	On request
MOD				
mod.	cm	cm	nr	nr
TN/DT SPECIAL 2100	210	40	60	5
TN/DT SPECIAL 2500	250	40	72	6

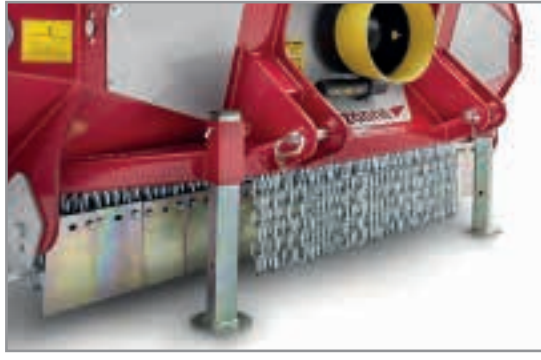
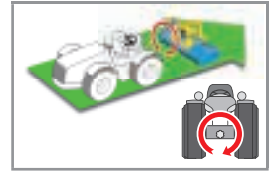

Portellone con comando idraulico e doppia fila di catene antiurto
Hydraulic door and double safety chain line
Hydraulische einstellbare Heckklappe und Doppelte Kettenreihe
Puerta trasera accionada hidráulicamente y doble fila de cadenas
Portillon avec commande hydraulique et double rangée de chaînes antichocs

Descrizioni, dati e foto sono indicative e possono anche riguardare attrezzature non di serie fornibili a richiesta.
All descriptions, specifications and pictures in this brochure should be considered approximate and may include optional equipment that is not part of the standard specifications.
Angaben und Abbildungen sind als annähernd zu betrachten und können auch nicht zum serienmäßigen Lieferumfang gehörende Sonderausstattungen enthalten.
Las indicaciones y las imágenes deben considerarse aproximadas y pueden contener equipos especiales que no forman parte del suministro de serie.
Les descriptions, les caractéristiques techniques et les photos ont un but purement indicatif et peuvent également concerner des équipements non de série, mais fournis que sur demande.

cod.	A richiesta	On request	Auf Anfrage	Opcionales	Sur demande
5223040	Spuntoni di raccolta	Pick-up teeth	Aufnahmezinken	Púas de recogida	Dents de ramassage

cod.	Ricambi	Spare parts	Ersatzteile	Recambios	Pièces de rechange
5354075	Cinghia SPB-2020	Cug belt SPB-2020	Keilriemen SPB-2020	Correa SPB-2020	Courroie SPB-2020
3231294	Dente - W	Utensils - W	Werkzeug - W	Utensilios - W	Utensils - W
5130030	Cardano T-90+FR	PTO shaft T-90+FR	Gelenkwelle T-90+FR	Cardán T-90+FR	Cardan T-90+FR
5130028	2x cardano trasm. laterale TF 2100	Double PTO connection TF 2100	Doppelter seitlicher kard. TF 2100	2x cardán trasm. lateral TF 2100	2x cardan transm. latérale TF 2100
5130029	2x cardano trasm. laterale TF 2500	Double PTO connection TF 2500	Doppelter seitlicher kard. TF 2500	2x cardán trasm. lateral TF 2500	2x cardan transm. latérale TF 2500
2020093	Scatola di trasmissione	Gear box	Getriebe	Caja de engranajes	Boîtier de transmission



TN/DT SPECIAL

Impiego

La trincia argini TMJ, grazie alla sua adattabilità, trova largo utilizzo su vari tipi di terreno: giardini, prati e parchi. È utilizzabile sia in posizione centrale sia in posizione laterale da +90° a -45° di inclinazione, con spostamento laterale variabile a seconda del modello utilizzato.

Use

Thanks to an extensive range of adjustment, the TMJ verge mulcher can be used on all kinds of terrain, gardens and parks. The TMJ mower can be used centrally aligned or laterally displaced and functions at any angle from +90° to -45°. Lateral movement varies according to the model.

Verwendung

Dank seiner Anpassungsfähigkeit wird das Seitenmulchgerät auf verschiedenen Arten von Land eingesetzt: Gärten, Rasenflächen und Parks. Er kann sowohl in zentraler als auch in seitlicher Position von +90° bis -45° Neigung eingesetzt werden. TMJ ist für Traktoren mit niedriger Leistung vorgesehen.

Uso

La trituradora para riberas TMJ se utiliza en vario tipo de terreno: prados, jardines o parques. Se utiliza en posición central y en posición lateral con una inclinación comprendida entre +90° y -45°, con desplazamiento lateral que varía de acuerdo con el modelo utilizado.

Utilisation

Le broyeur d'acotement TMJ, grâce à son adaptabilité, est largement utilisé sur variés types de terrain: jardins, pelouses et parcs. Utilisable aussi bien en position centrale qu'en position latérale, il a une plage de travail comprise entre +90° et -45° d'inclinaison, et un déport latéral qui varie en fonction du modèle utilisé.

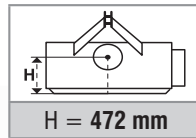
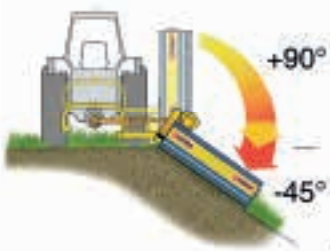

Inclinazione trincia
Inclination schredder
Neigungswinkel Mulchers
Inclinación trituradora
Inclinaison broyeur



Di serie
Standard
Serienmässig
Estándar
De série

Requisiti del trattore - Tractor requirements
Traktor anforderungen - Requisitos del tractor
Exigences relatives au tracteur



mod.	cod.	cod.	HP	kg	cm	rpm/min	type	nr (type)	cm	kg
TMJ 1200	1002825	1002822	25-35	800-1500	110	540	T-40 (T-40 OM)	3 (BX 40)	143×137×85	295
TMJ 1400	1002826	1002823	25-35	1100-1800	130	540	T-40 (T-40 OM)	3 (BX 40)	161×137×85	310

2060815

Supplemento per cardano doppio omocinetico • Surcharge for double wide angle cardan shaft • Aufpreis für doppelte Weitwinkelgelenkwelle • Recargo de transmisión cardanica con doble nudo homocinetico • Supplément pour cardan double homocinétique

Di serie	Standard equipment	Serienmässig	Estándar	De série
<ul style="list-style-type: none"> Scatola di trasmissione con ruota libera PTO 1 3/8" Z6 Cardano Rotore con sistema di taglio elicoidale Spostamento laterale idraulico Angolare rompitore Slitte d'appoggio regolabili in altezza Rullo ozioso posteriore regolabile in altezza (114 mm) Raschifango per pulizia rullo ozioso Scarico anteriore rullo ozioso Protezione posteriore in gomma Protezione anteriore a bandinelle Protezioni antinfortunistiche conformi alla normativa CE 	<ul style="list-style-type: none"> Gearbox with freewheel clutch PTO 1 3/8" Z6 PTO drive shaft Rotor with helical cutting system Hydraulic side shift Corner reinforcement for shredding material Height-adjustable skids Rear levelling roller height adjustable (114 mm) Scraper for rear levelling roller Discharge of the material over the levelling roller Rear protection with rubber Front protection with metal flaps Protective equipment as per EC safety rules 	<ul style="list-style-type: none"> Getriebe mit integriertem Freilauf PTO 1 3/8" Z6 Gelenkwelle Spiralrotor Hydraulische Seitenverschiebung Eckenverstärkung für Zerkleinerungsmaterial Höhenverstellbare Stützkufen Hintere Stützwalze höhenverstellbar (114 mm) Walzenabstreifer Entladung des Materials über die Walze Hinterer Gummischutz Frontschutz mit Metallklappen Unfallschutz nach EU-Vorschriften 	<ul style="list-style-type: none"> Caja de engranajes con rueda libre TDF 1 3/8" Z6 Transmisión cardanica Rotor con sistema de corte helicoidal Desplazamiento lateral hidráulico Rompedor angular Patines de apoyo regulable en altura Rodillo nivelador trasero (114 mm), con regulación en altura Limpiador montado en el rodillo nivelador trasero Descarga anterior al rodillo nivelador Protección posterior en goma Protección delantera mediante placas metálicas Protecciones de seguridad de acuerdo con la norma CE 	<ul style="list-style-type: none"> Boîtier de transmission avec roue libre PDF 1 3/8" Z6 Cardan Rotor avec système de coupe hélicoïdal Déport latéral hydraulique Barre brisante Patins d'appui réglables en hauteur Rouleau d'appui arrière réglable en hauteur (114 mm) Racleur pour le rouleau d'appui Ejection devant le rouleau d'appui Protection arrière en caoutchouc Protection avant avec volets métalliques Protections contre les accidents aux normes CE

TMJ	OFF-SET MULCHER FOR COMPACT TRACTORS
TMJ	SEITENMULCHER: LEICHTE AUSFÜHRUNG
TMJ	DESBROZADORA - TRITURADORA DE BRAZO PARA ACOPLAR EN PEQUEÑOS TRACTORES
TMJ	BROYEUR D'ACCOTEMENT POUR MICRO-TRACTEURS

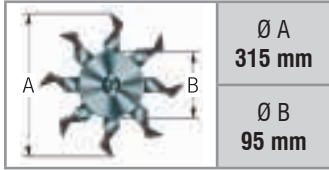

Ø A
315 mm

Ø B
95 mm

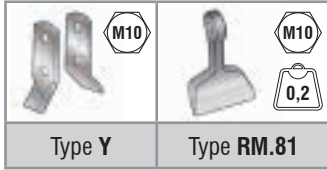

Type Y

Type RM.81



Sistema di taglio elicoidale
Helical cutting system
Spiralrotor
Sistema de corte helicoidal
Système de coupe hélicoïdal

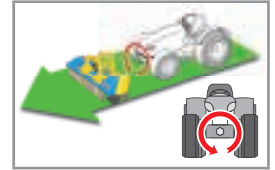

MOVEMENT MACHINE

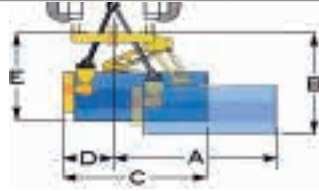

WORKING WIDTH

Standard



mod.

A

B

C

D

E

cm

nr

nr

TMJ 1200

186

143

143

71

135

120

76

38

TMJ 1400

204

143

161

71

135

140

88

44

cod.

A richiesta

On request

Auf Anfrage

Opcionales

Sur demande

5130015

Cardano T-40 OM omocinetico

Double wide angle PTO shaft T-40 OM

Doppelte Weitwinkelgelenkwelle T-40 OM

Cardán T-40 OM homocinetico

Cardan T-40 OM homocinétique

2051281

Sistema auto-livellamento trincia

Mulcher self-levelling system

Mulcher-Selbstnivellierungssystem

Sistema autonivelante trituradora

Système de nivellement automatique

cod.

Ricambi

Spare parts

Ersatzteile

Recambios

Pièces de rechange

5354087

Cinghia BX40

Cug belt BX40

Keilriemen BX40

Correa BX40

Courroie BX40

5315007

Vite M10 per utensile

M10 screw for tool

M10 Schraube für Werkzeug

Tornillo M10 para herramienta

Vis M10 pour outil

5323015

Dado M10 per utensile

M10 nut for tool

M10 Mutter für Werkzeug

Tuerca M10 para herramienta

Ecrou M10 pour outil

5350114

Mazza RM.81

Hammer RM.81

Hammer RM.81

Martillo RM.81

Marteau RM.81

5350059

Coltello "Y"

"Y" blade

"Y" Messer

Cuchilla "Y"

Couteau "Y"

5130014

Cardano T-40

PTO shaft T-40

Gelenkwelle T-40

Cardán T-40

Cardan T-40

2020047

Scatola trasmissione

Gear box

Getriebe

Caja de engranajes

Boîtier de transmission



cod. 2051281
On request

Sistema auto-livellamento trincia con catena di sicurezza
Mulcher self-levelling system with safety chain
Mulcher-Selbstnivellierungssystem mit Sicherheitsketten
Sistema autonivelante trituradora con cadena de seguridad
Système de nivellement automatique du broyeur avec chaîne de sécurité



SISTEMA ANTISHOCK



Consente l'attenuazione dell'urto tra trincia argini ed eventuali sassi o ostacoli durante il taglio, ciò permette l'utilizzo del trincia anche in terreni rocciosi o accidentati.

Allows attenuation of impact between verge and any stones or obstacles when cutting, which allows the use of mulches in rocky or uneven terrain.

Ermöglicht die Dämpfung des Aufpralls zwischen dem Randstreifen und Steinen oder Hindernissen beim Schneiden, was die Verwendung von Mulcher in felsigem oder unebenem Gelände ermöglicht.

Permite la atenuación del impacto entre el borde y las piedras u obstáculos al corte, que permite el uso de coberturas en terreno rocoso o irregular.

Permet l'atténuation de l'impact entre point et toutes les pierres ou des obstacles lors de la coupe, ce qui permet l'utilisation de paillis en terrain rocheux ou inégale.



TMO

Impiego Use Verwendung Uso Utilisation

Si presta in modo ottimale per lavori di pulizia da ramaglie ed erbacce di argini, banchine stradali, vigneti e frutteti in genere. È utilizzabile sia in posizione centrale sia in posizione laterale da +90° a -50° di inclinazione, con spostamento laterale variabile a seconda del modello utilizzato.

It is ideal for mulching grass and twigs in ditches, on verges, embankments, and in vineyards and orchards in general. The TMO mower can be used centrally aligned or laterally displaced and functions at any angle from +90° to -50°. Lateral movement varies according to the model.

Das TMO Seitenmulchgerät ist ideal zum Mulchen von Gras und Zweigen in Gräben, an Böschungen, und allgemein in Wein- und Obstgärten. Das TMO kann zentral ausgerichtet oder seitlich versetzt eingesetzt werden und funktioniert in jedem Winkel von +90° bis -50°. Die seitliche Bewegung variiert je nach Modell.

Esta máquina es excelente para los trabajos de limpieza de ramas y malezas de terraplenes, bordes de caminos, viñedos y plantaciones frutales en general. Se utiliza en posición central y en posición lateral y ofrece la posibilidad de trabajar con una inclinación comprendida entre +90° y -50°, con desplazamiento lateral que varía de acuerdo con el modelo utilizado.

Cet équipement est particulièrement indiqué pour l'élimination des branches mortes et des herbes hautes dans les travaux d'entretien des berges, des accotements routiers, des talus, des vignes et des vergers en général. Utilisable aussi bien en position centrale qu'en position latérale, il a une plage de travail comprise entre +90° et -50° d'inclinaison, et un déport latéral qui varie en fonction du modèle utilisé.

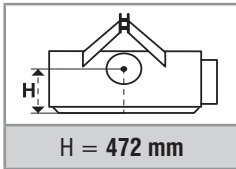

Inclinazione trincia
Inclination schredder
Neigungswinkel Mulchers
Inclinación trituradora
Inclinaison broyeur



Di serie
Standard
Serienmässig
Estándar
De série

Requisiti del trattore - Tractor requirements
Traktor anforderungen - Requisitos del tractor
Exigences relatives au tracteur

mod.	cod.	cod.	rpm/min	HP	kg	cm	type	nr (type)	cm	kg	
TMO 1300	1002407	1002408	540/1000	35-70	1900-2800	130	T-40 (T-40 OM)	3 (BX 45)	150×134×100	360	
TMO 1500	1002409	1002410	540/1000	35-70	2400-3300	160	T-40 (T-40 OM)	3 (BX 45)	170×134×100	390	
TMO 1700	1002411	1002412	540/1000	35-70	2900-3500	180	T-40 (T-40 OM)	3 (BX 45)	190×134×100	410	
		2060815	Supplemento per cardano doppio omocinetico • Surcharge for double wide angle cardan shaft • Aufpreis für doppelte Weitwinkelgelenkwelle • Recargo de transmisión cardanica con doble nudo homocinetico • Supplément pour cardan double homocinétique								

Di serie	Standard equipment	Serienmässig	Estándar	De série
<ul style="list-style-type: none"> Scatola di trasmissione con ruota libera PTO 1 3/8" Z6 Cardano Rotore con sistema di taglio elicoidale Spostamento laterale idraulico Angolare rompitoro Slitte d'appoggio regolabili in altezza Rullo ozioso posteriore regolabile in altezza (114 mm) Raschiafango per pulizia rullo ozioso Scarico anteriore rullo ozioso Cofano apribile (solo per ispezione) Protezione anteriore in gomma Protezione posteriore in gomma Protezione anteriore a catene Protezioni antinfortunistiche conformi alla normativa CE 	<ul style="list-style-type: none"> Gearbox with freewheel clutch PTO 1 3/8" Z6 PTO drive shaft Rotor with helical cutting system Hydraulic side shift Corner reinforcement for shredding material Height-adjustable skids Rear levelling roller height adjustable (114 mm) Scraper for rear levelling roller Discharge of the material over the levelling roller Opening hood (for inspection only) Front protection with rubber Rear protection with rubber Front protection with chains Protective equipment as per EC safety rules 	<ul style="list-style-type: none"> Getriebe mit integriertem Freilauf PTO 1 3/8" Z6 Gelenkwelle Spiralrotor Hydraulische Seitenverschiebung Eckenverstärkung für Zerkleinerungsmaterial Höhenverstellbare Stützkufen Hintere Stützwalze höhenverstellbar (114 mm) Walzenabstreifer Entladung des Materials über die Walze Heckhaube (darf nur für Wartungsarbeiten geöffnet werden) Frontschutz mit Gummileiste Hinterer Gummischutz Frontschutz mit Ketten Unfallschutz nach EU-Vorschriften 	<ul style="list-style-type: none"> Caja de engranajes con rueda libre PDF 1 3/8" Z6 Transmisión cardanica Rotor con sist. de corte helicoidal Desplazamiento lateral hidrául. Rompedor angular Patines de apoyo reg. en altura Rodillo nivelador trasero (114 mm), con regulación en altura Limpiador montado en el rodillo nivelador trasero Descarga anterior al rodillo nivelador Portón trasero aperturable (solo para inspección) Protección frontal en goma Protección posterior en goma Protección anterior a cadenas Protecciones de seguridad de acuerdo con la norma CE 	<ul style="list-style-type: none"> Boîtier de transmission avec roue libre PDF 1 3/8" Z6 Cardan Rotor avec système de coupe hélicoïdal Déport latéral hydraulique Barre brisante Patins d'appui réglables en hauteur Rouleau d'appui arrière réglable en hauteur (114 mm) Racleur pour le rouleau d'appui Ejection devant le rouleau d'appui seulement) Protection avant en caoutchouc Protection arrière en caoutchouc Protection avant avec chaînes Protections contre les accidents aux normes CE

TMO	LIGHT DUTY OFF-SET MULCHER
TMO	SEITENMULCHER: LEICHTE AUSFÜHRUNG
TMO	TRITURADORA PARA RIBERAS
TMO	BROYEUR D'ACCOTEMENT

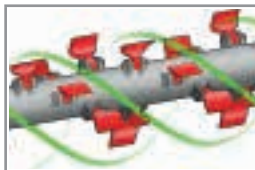
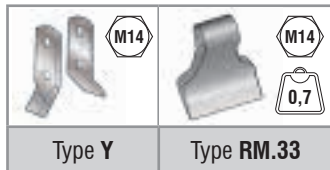
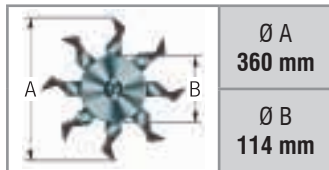

Sistema di taglio elicoidale
Helical cutting system
Spiralrotor
Sistema de corte helicoidal
Système de coupe hélicoïdal



MOVEMENT MACHINE

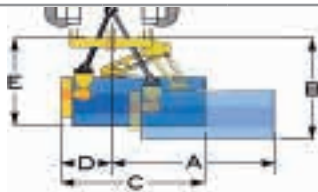

WORKING WIDTH

Standard



mod.	A	B	C	D	E
TMO 1300	184	170	150	74	140
TMO 1500	205	170	171	74	140
TMO 1700	225	170	191	74	140

cm	nr	nr
130	36	18
150	44	22
170	48	24

cod.	A richiesta	On request	Auf Anfrage	Opcionales	Sur demande
5130015	Cardano T-40 OM omocinetico	Double wide angle PTO shaft T-40 OM	Doppelte Weitwinkelgelenkwelle T-40 OM	Cardán T-40 OM homocinetico	Cardan T-40 OM homocinétique
2051282	Sistema auto-livellamento trincia	Mulcher self-levelling system	Mulcher-Selbstnivellierungssystem	Sistema autonivelante trituradora	Système de nivellement automatique

cod.	Ricambi	Spare parts	Ersatzteile	Recambios	Pièces de rechange
5354019	Cinghia BX45	Cug belt BX45	Keilriemen BX45	Correa BX45	Courroie BX45
5315011	Vite M14 per utensile	M14 screw for tool	M14 Schraube für Werkzeug	Tornillo M14 para herramienta	Vis M14 pour outil
5323016	Dado M14 per utensile	M14 nut for tool	M14 Mutter für Werkzeug	Tuerca M14 para herramienta	Ecrou M14 pour outil
5350047	Mazza RM.33	Hammer RM.33	Hammer RM.33	Martillo RM.33	Marteau RM.33
5350040	Coltello "Y"	"Y" blade	"Y" Messer	Cuchilla "Y"	Couteau "Y"
5130014	Cardano T-40	PTO shaft T-40	Gelenkwelle T-40	Cardán T-40	Cardan T-40
2020047	Scatola trasmissione	Gear box	Getriebe	Caja de engranajes	Boîtier de transmission



cod. 2051282
On request

Sistema auto-livellamento trincia con catena di sicurezza
Mulcher self-levelling system with safety chain
Mulcher-Selbstnivellierungssystem mit Sicherheitsketten
Sistema autonivelante trituradora con cadena de seguridad
Système de nivellement automatique du broyeur avec chaîne de sécurité



Trasporto su strada
Road transport
Straßentransport
Transporte en carretera
Transport sur route

SISTEMA ANTISHOCK



Consente l'attenuazione dell'urto tra trincia argini ed eventuali sassi o ostacoli durante il taglio, ciò permette l'utilizzo del trincia anche in terreni rocciosi o accidentati.

Allows attenuation of impact between verge and any stones or obstacles when cutting, which allows the use of mulches in rocky or uneven terrain.

Ermöglicht die Dämpfung des Aufpralls zwischen dem Randstreifen und Steinen oder Hindernissen beim Schneiden, was die Verwendung von Mulcher in felsigem oder unebenem Gelände ermöglicht.

Permite la atenuación del impacto entre el borde y las piedras u obstáculos al corte, que permite el uso de coberturas en terreno rocoso o irregular.

Permet l'atténuation de l'impact entre point et toutes les pierres ou des obstacles lors de la coupe, ce qui permet l'utilisation de paillis en terrain rocheux ou inégale.



Posizione laterale verticale
Vertical side position
Senkrechte Position
Posición lateral vertical
Position latérale verticale

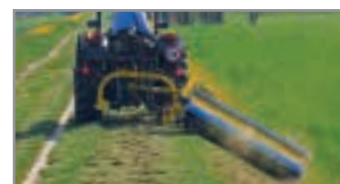

Posizione laterale inclinata
Inclined side position
Geneigte Position
Posición lateral inclinada
Position latérale inclinée

Impiego	Use	Verwendung	Uso	Utilisation
---------	-----	------------	-----	-------------

Si presta in modo ottimale per lavori di pulizia da ramaglie ed erbacce di argini, banchine stradali, vigneti e frutteti in genere. È utilizzabile sia in posizione centrale sia in posizione laterale da +90° a -50° di inclinazione, con spostamento laterale variabile a seconda del modello utilizzato.

It is ideal for mulching grass and twigs in ditches, on verges, embankments, and in vineyards and orchards in general. The TMO-SE mower can be used centrally aligned or laterally displaced and functions at any angle from +90° to -50°. Lateral movement varies according to the model.

Das TMO Seitenmulchgerät ist ideal zum Mulchen von Gras und Zweigen in Gräben, an Böschungen, und allgemein in Wein- und Obstgärten. Das TMO kann zentral ausgerichtet oder seitlich versetzt eingesetzt werden und funktioniert in jedem Winkel von +90° bis -50°. Die seitliche Bewegung variiert je nach Modell.

Esta máquina es excelente para los trabajos de limpieza de ramas y malezas de terraplenes, bordes de caminos, viñedos y plantaciones frutales en general. Se utiliza en posición central y en posición lateral y ofrece la posibilidad de trabajar con una inclinación comprendida entre +90° y -50°, con desplazamiento lateral que varía de acuerdo con el modelo utilizado.

Cet équipement est particulièrement indiqué pour l'élimination des branches mortes et des herbes hautes dans les travaux d'entretien des berges, des accotements routiers, des talus, des vignes et des vergers en général. Utilisable aussi bien en position centrale qu'en position latérale, il a une plage de travail comprise entre +90° et -50° d'inclinaison, et un déport latéral qui varie en fonction du modèle utilisé.

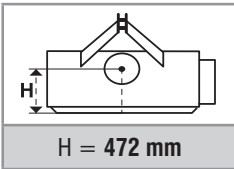

Inclinazione trincia
Inclination schredder
Neigungswinkel Mulchers
Inclinación trituradora
Inclinaison broyeur

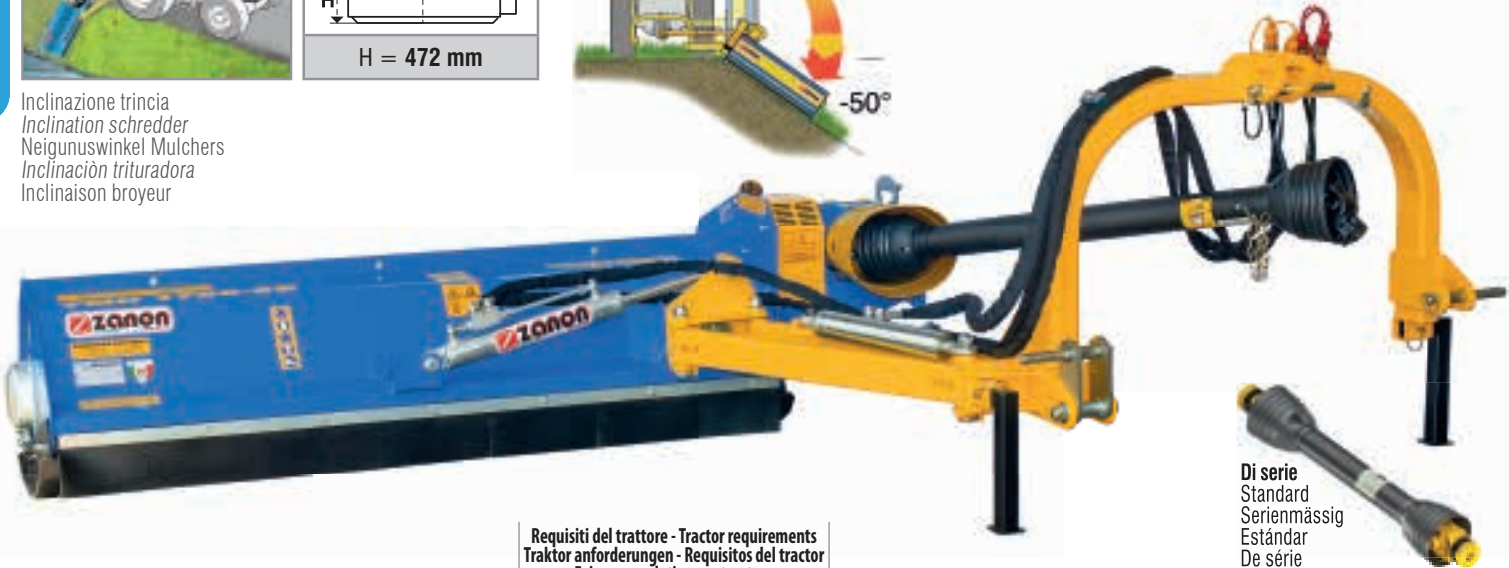

Di serie
Standard
Serienmässig
Estándar
De série

Requisiti del trattore - Tractor requirements
Traktor anforderungen - Requisitos del tractor
Exigences relatives au tracteur

mod.	cod.	cod.	rpm/min	HP	kg	cm	type	nr (type)	cm	kg
TMO-SE 1300	1003839	1003842	540/1000	35-70	1900-2800	130	T-40 (T-40 OM)	3 (BX 45)	177×144×96	360
TMO-SE 1500	1003840	1003843	540/1000	35-70	2400-3300	160	T-40 (T-40 OM)	3 (BX 45)	197×144×96	390
TMO-SE 1700	1003841	1003844	540/1000	35-70	2900-3500	180	T-40 (T-40 OM)	3 (BX 45)	217×144×96	410
2060815			Supplemento per cardano doppio omocinetico • Surcharge for double wide angle cardan shaft • Aufpreis für doppelte Weitwinkelgelenkwelle • Recargo de transmisión cardánica con doble nudo homocinetico • Supplément pour cardan double homocinétique							

Di serie	Standard equipment	Serienmässig	Estándar	De série
<ul style="list-style-type: none"> Scatola di trasmissione con ruota libera PTO 1 3/8" Z6 Cardano Rotore con sistema di taglio elicoidale Spostamento laterale idraulico Angolare rompitore Slitte d'appoggio regolabili in altezza Rullo ozioso posteriore regolabile in altezza (114 mm) Raschifango per pulizia rullo ozioso Scarico anteriore rullo ozioso Cofano apribile (solo per ispezione) Protezione anteriore in gomma Protezione posteriore in gomma Protezione anteriore a catene Protezioni antinfortunistiche conformi alla normativa CE 	<ul style="list-style-type: none"> Gearbox with freewheel clutch PTO 1 3/8" Z6 PTO drive shaft Rotor with helical cutting system Hydraulic side shift Corner reinforcement for shredding material Height-adjustable skids Rear levelling roller height adjustable (114 mm) Scraper for rear levelling roller Discharge of the material over the levelling roller Opening hood (for inspection only) Front protection with rubber Rear protection with rubber Front protection with chains Protective equipment as per EC safety rules 	<ul style="list-style-type: none"> Getriebe mit integriertem Freilauf PTO 1 3/8" Z6 Gelenkwelle Spiralrotor Hydraulische Seitenverschiebung Eckenverstärkung für Zerkleinerungsmaterial Höhenverstellbare Stützkufen Hintere Stützwalze höhenverstellbar (114 mm) Walzenabstreifer Entladung des Materials über die Walze Heckhaube (darf nur für Wartungsarbeiten geöffnet werden) Frontschutz mit Gummileiste Hinterer Gummischutz Frontschutz mit Ketten Unfallschutz nach EU-Vorschriften 	<ul style="list-style-type: none"> Caja de engranajes con rueda libre TDF 1 3/8" Z6 Transmisión cardánica Rotor con sist. de corte helicoidal Desplazamiento lateral hidrául. Rompedor angular Patines de apoyo reg. en altura Rodillo nivelador trasero (114 mm), con regulación en altura Limpiador montado en el rodillo nivelador trasero Descarga anterior al rodillo nivelador Portón trasero aperturable (solo para inspección) Protección frontal en goma Protección posterior en goma Protección anterior a cadenas Protecciones de seguridad de acuerdo con la norma CE 	<ul style="list-style-type: none"> Boîtier de transmission avec roue libre PDF 1 3/8" Z6 Cardan Rotor avec système de coupe hélicoïdal Déport latéral hydraulique Barre brisante Patins d'appui réglables en hauteur Rouleau d'appui arrière réglable en hauteur (114 mm) Racleur pour le rouleau d'appui Ejection devant le rouleau d'appui Capot ouvrant (pour inspection seulement) Protección avant en caoutchouc Protection arrière en caoutchouc Protection avant avec chaînes Protections contre les accidents aux normes CE

TMO-SE	LIGHT DUTY OFF-SET MULCHER
TMO-SE	SEITENMULCHER: LEICHTE AUSFÜHRUNG
TMO-SE	TRITURADORA PARA RIBERAS
TMO-SE	BROYEUR D'ACCOTEMENT

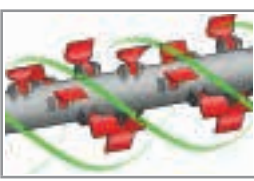
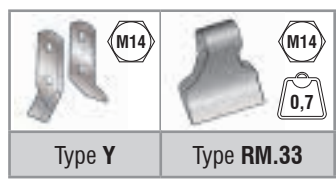
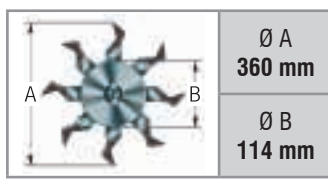

Sistema di taglio elicoidale
Helical cutting system
Spiralrotor
Sistema de corte helicoidal
Système de coupe hélicoïdal

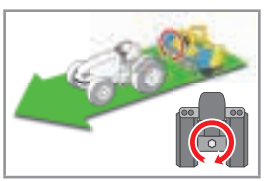

MOVEMENT MACHINE

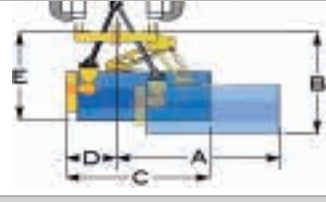

WORKING WIDTH	Standard	
cm	nr	nr
130	36	18
150	44	22
170	48	24

mod.	A	B	C	D	E
TMO-SE 1300	220	164	177	74	134
TMO-SE 1500	230	164	197	74	134
TMO-SE 1700	250	164	217	74	134

cod.	A richiesta	On request	Auf Anfrage	Opcionales	Sur demande
5130015	Cardano T-40 OM omocinetico	Double wide angle PTO shaft T-40 OM	Doppelte Weitwinkelgelenkwelle T-40 OM	Cardán T-40 OM homocinetico	Cardan T-40 OM homocinétique
2051282	Sistema auto-livellamento trincia	Mulcher self-levelling system	Mulcher-Selbstnivellierungssystem	Sistema autonivelante trituradora	Système de nivellement automatique

cod.	Ricambi	Spare parts	Ersatzteile	Recambios	Pièces de rechange
5354019	Cinghia BX45	Cug belt BX45	Keilriemen BX45	Correa BX45	Courroie BX45
5315011	Vite M14 per utensile	M14 screw for tool	M14 Schraube für Werkzeug	Tornillo M14 para herramienta	Vis M14 pour outil
5323016	Dado M14 per utensile	M14 nut for tool	M14 Mutter für Werkzeug	Tuerca M14 para herramienta	Ecrou M14 pour outil
5350047	Mazza RM.33	Hammer RM.33	Hammer RM.33	Martillo RM.33	Marteau RM.33
5350040	Coltello "Y"	"Y" blade	"Y" Messer	Cuchilla "Y"	Couteau "Y"
5130014	Cardano T-40	PTO shaft T-40	Gelenkwelle T-40	Cardán T-40	Cardan T-40
2020184	Scatola trasmissione	Gear box	Getriebe	Caja de engranajes	Boîtier de transmission



cod. 2051282
On request
Sistema auto-livellamento trincia con catena di sicurezza
Mulcher self-levelling system with safety chain
Mulcher-Selbstnivellierungssystem mit Sicherheitsketten
Sistema autonivelante trituradora con cadena de seguridad
Système de nivellement automatique du broyeur avec chaîne de sécurité



Posizione laterale verticale
Vertical side position
Senkrechte Position
Posición lateral vertical
Position latérale verticale

SISTEMA ANTISHOCK

Consente l'attenuazione dell'urto tra trincia argini ed eventuali sassi o ostacoli durante il taglio, ciò permette l'utilizzo del trincia anche in terreni rocciosi o accidentati.
Allows attenuation of impact between verge and any stones or obstacles when cutting, which allows the use of mulches in rocky or uneven terrain.
Ermöglicht die Dämpfung des Aufpralls zwischen dem Randstreifen und Steinen oder Hindernissen beim Schneiden, was die Verwendung von Mulcher in felsigem oder unebenem Gelände ermöglicht.
Permite la atenuación del impacto entre el borde y las piedras u obstáculos al corte, que permite el uso de coberturas en terreno rocoso o irregular.
Permet l'atténuation de l'impact entre point et toutes les pierres ou des obstacles lors de la coupe, ce qui permet l'utilisation de paillis en terrain rocheux ou inégale.



Posizione laterale inclinata
Inclined side position
Geneigte Position
Posición lateral inclinada
Position latérale inclinée

TMO-SE

Impiego

Si presta in modo ottimale per lavori di pulizia da ramaglie ed erbacce di argini, banchine stradali, vigneti e frutteti in genere. È utilizzabile sia in posizione centrale sia in posizione laterale da +90° a -55° di inclinazione, con spostamento laterale variabile a seconda del modello utilizzato.

Use

It is ideal for mulching grass and twigs in ditches, on verges, embankments, and in vineyards and orchards in general. The mower can be used centrally aligned or laterally displaced and functions at any angle from +90° to -55°. Lateral movement varies according to the model.

Verwendung

Das TMC Seitenmulchgerät ist ideal zum Mulchen von Gras und Zweigen in Gräben, an Böschungen, und allgemein in Wein- und Obstgärten. Das kann zentral ausgerichtet oder seitlich versetzt eingesetzt werden und funktioniert in jedem Winkel von +90° bis -55°. Die seitliche Bewegung variiert je nach Modell.

Uso

Esta máquina es excelente para los trabajos de limpieza de ramas y malezas de terraplenes, bordes de caminos, viñedos y plantaciones frutales en general. Se utiliza en posición central y en posición lateral y ofrece la posibilidad de trabajar con una inclinación comprendida entre +90° y -55°, con desplazamiento lateral que varía de acuerdo con el modelo utilizado.

Utilisation

Cet équipement est particulièrement indiqué pour l'élimination des branches mortes et des herbes hautes dans les travaux d'entretien des berges, des accotements routiers, des talus, des vignes et des vergers en général. Utilisable aussi bien en position centrale qu'en position latérale, il a une plage de travail comprise entre +90° et -55° d'inclinaison, et un déport latéral qui varie en fonction du modèle utilisé.

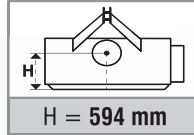
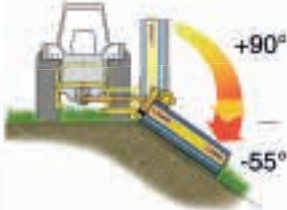

Inclinazione trincia
Inclination schredder
Neigungswinkel Mulchers
Inclinación trituradora
Inclinaison broyeur



Di serie
Standard
Serienmässig
Estándar
De série

mod.	cod.	cod.	HP	kg	rpm/min	type	nr (type)	cm	kg
TMC 1300	1002318	1002322	50 - 100	2500	540/1000	T-50 (T-70 OM)	3 (XPB 1250)	155×168×100	610
TMC 1600	1002319	1002323	60 - 100	2500	540/1000	T-50 (T-70 OM)	3 (XPB 1250)	185×168×100	640
TMC 1900	1002320	1002324	70 - 120	3000	540/1000	T-50 (T-70 OM)	4 (XPB 1250)	215×168×100	690
TMC 2250	1002321	1002325	90 - 150	3500	540/1000	T-50 (T-70 OM)	5 (XPB 1250)	240×168×100	760
2060816			Supplemento per cardano doppio omocinetico • Surcharge for double wide angle cardan shaft • Aufpreis für doppelte Weitwinkelgelenkwelle • Recargo de transmisión cardánica con doble nudo homocinético • Supplément pour cardan double homocinétique						

Di serie	Standard equipment	Serienmässig	Estándar	De série
<ul style="list-style-type: none"> Scatola di trasmissione con ruota libera PTO 1 3/8" Z6 Cardano Rotore con sist. di taglio lineare Spostamento laterale idraulico Angolare rompitoro Slitte d'appoggio regolabili in altezza Rullo ozioso posteriore regolabile in altezza (140 mm) Raschifango per pulizia rullo ozioso Scarico anteriore rullo ozioso Cofano apribile (solo per ispezione) Telaio con doppia lamiera Protezione anteriore in gomma Protezione posteriore in gomma Protezione anteriore a catene Protezioni antinfortunistiche conformi alla normativa CE 	<ul style="list-style-type: none"> Gearbox with freewheel clutch PTO 1 3/8" Z6 PTO drive shaft Rotor with linear cutting system Hydraulic side shift Corner reinforcement for shredding material Height-adjustable skids Rear levelling roller height adjustable (140 mm) Scraper for rear levelling roller Discharge of the material over the levelling roller Opening hood (for inspec. only) Double skinned frame Front protection with rubber Rear protection with rubber Front protection with chains Protective equipment as per EC safety rules 	<ul style="list-style-type: none"> Getriebe mit integriertem Freilauf PTO 1 3/8" Z6 Gelenkwelle Rotor mit linear Schnittsystem Hydraulische Seitenverschiebung Eckenverstärkung für Zerkleinerungsmaterial Höhenverstellbare Stützkufen Hintere Stützwalze höhenverstellbar (140 mm) Walzenabstreifer Entladung des Materials über die Walze Heckhaube (darf nur für Wartungsarbeiten geöffnet werden) Doppelwandiger Rahmen Frontschutz mit Gummileiste Hintere Gummischutz Frontschutz mit Ketten Unfallschutz nach EU-Vorschriften 	<ul style="list-style-type: none"> Caja de engranajes con rueda libre TDF 1 3/8" Z6 Transmisión cardanica Rotor con sistema de corte lineal Desplazamiento lateral hidrául. Rompedor angular Patines de apoyo reg. en altura Rodillo nivelador trasero (140 mm), con regulación en altura Limpiador montado en el rodillo nivelador trasero Descarga ant. al rodillo nivelador Portón trasero aperturable (solo para inspección) Interior del cuerpo de maquina, con doble chapa Protección frontal en goma Protección posterior en goma Protección anterior a cadenas Protecciones de seguridad de acuerdo con la norma CE 	<ul style="list-style-type: none"> Boîtier de transmission avec roue libre PDF 1 3/8" Z6 Cardan Rotor avec système de coupe linéaire Déport latéral hydraulique Barre brisante Patins d'appui rég. en hauteur Rouleau d'appui arrière réglable en hauteur (140 mm) Racleur pour le rouleau d'appui Ejection devant le rouleau d'appui Capot ouvrant (pour inspection seulement) Caisson renf. par blindage interne Protection avant en caoutchouc Protection arrière en caoutchouc Protection avant avec chaînes Protections contre les accidents aux normes CE

TMC	OFF-SET MULCHER MEDIUM DUTY WITH INTERNAL GEARBOX
TMC	SEITENMULCHER: MITTELSCHWERE AUSFÜHRUNG MIT INNENGETRIEBE
TMC	TRITURADORA PARA RIBERAS PESADA - CAJA DE TRANSMISIÓN INTERIOR
TMC	BROYEUR D'ACCOTEMENT LOURD - BÔTE DE TRANSMISSION INTÉRIEURE

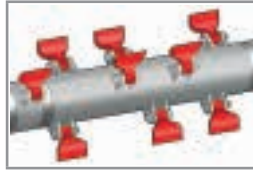
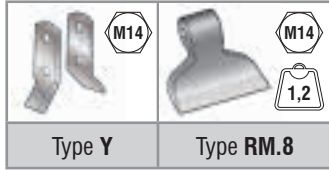
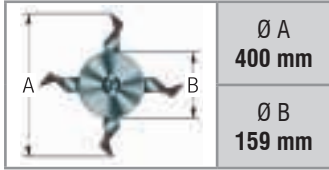

Sistema di taglio lineare
Linear cutting system
Linearroter
Sistema de corte lineal
Système de coupe linéaire



MOVEMENT MACHINE

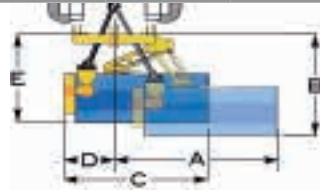

WORKING WIDTH

Standard



mod.	A	B	C	D	E
TMC 1300	213	228	155	86	168
TMC 1600	243	228	185	86	168
TMC 1900	273	228	215	86	168
TMC 2250	303	228	245	86	168

cm	nr	nr
130	32	16
160	40	20
190	48	24
225	56	28

cod.	A richiesta	On request	Auf Anfrage	Opcionales	Sur demande
5130013	Cardano T-70 OM omocinetico	Double wide angle PTO shaft T-70 OM	Doppelte Weitwinkelgelenkwelle T-70 OM	Cardán T-70 OM homocinetico	Cardan T-70 OM homocinétique
2051283	Sistema auto-livellamento trincia	Mulcher self-levelling system	Mulcher-Selbstnivellierungssystem	Sistema autonivelante trituradora	Système de nivellement automatique

cod.	Ricambi	Spare parts	Ersatzteile	Recambios	Pièces de rechange
5354003	Cinghia XPB 1250	Cug belt XPB 1250	Keilriemen XPB 1250	Correa XPB 1250	Courroie XPB 1250
5315011	Vite M14 per utensile	M14 screw for tool	M14 Schraube für Werkzeug	Tornillo M14 para herramienta	Vis M14 pour outil
5323016	Dado M14 per utensile	M14 nut for tool	M14 Mutter für Werkzeug	Tuerca M14 para herramienta	Ecrou M14 pour outil
5350024	Mazza RM.8	Hammer RM.8	Hammer RM.8	Martillo RM.8	Marteau RM.8
5350040	Coltello "Y"	"Y" blade	"Y" Messer	Cuchilla "Y"	Couteau "Y"
5130008	Cardano T-50	PTO shaft T-50	Gelenkwelle T-50	Cardán T-50	Cardan T-50
2020010	Scatola trasmissione	Gear box	Getriebe	Caja de engranajes	Boîtier de transmission

SISTEMA ANTISHOCK



Consente l'attenuazione dell'urto tra trincia argini ed eventuali sassi o ostacoli durante il taglio, ciò permette l'utilizzo del trincia anche in terreni rocciosi o accidentati.

Allows attenuation of impact between verge and any stones or obstacles when cutting, which allows the use of mulches in rocky or uneven terrain

Ermöglicht Dämpfung des Aufpralls zwischen Schwelle und alle Steine oder beim Schneiden, die die Verwendung von Laubdeck in felsigen oder unebenem Gelände ermöglicht Hindernisse

Permite la atenuación del impacto entre el borde y las piedras u obstáculos al corte, que permite el uso de coberturas en terreno rocoso o irregular

Permet l'atténuation de l'impact entre point et toutes les pierres ou des obstacles lors de la coupe, ce qui permet l'utilisation de paillis en terrain rocheux ou inégale

SISTEMA FLOTTANTE

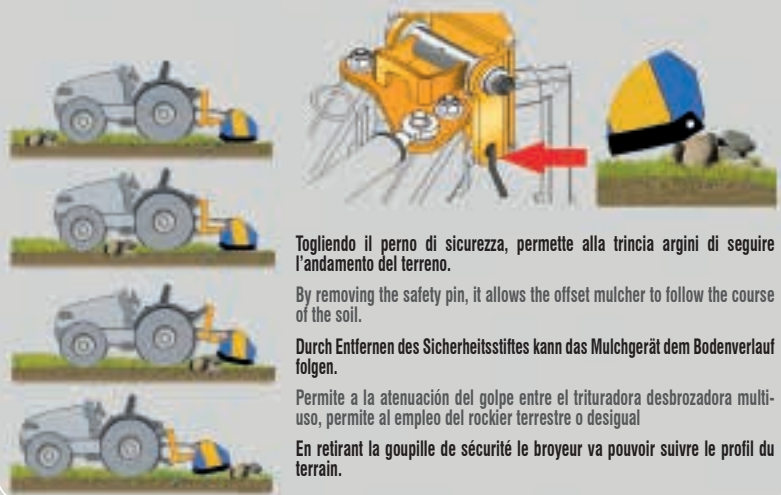

Togliendo il perno di sicurezza, permette alla trincia argini di seguire l'andamento del terreno.

By removing the safety pin, it allows the offset mulcher to follow the course of the soil.

Durch Entfernen des Sicherheitsstiftes kann das Mulchgerät dem Bodenverlauf folgen.

Permite a la atenuación del golpe entre el trituradora desbrozadora multi-uso, permite al empleo del rockier terrestre o desigual

En retirant la goupille de sécurité le broyeur va pouvoir suivre le profil du terrain.



Trasporto su strada
Road transport
Straßentransport
Transporte en carretera
Transport sur route



Posizione laterale verticale
Vertical side position
Senkrechte Position
Posición lateral vertical
Position latérale verticale



Posizione laterale inclinata
Inclined side position
Geneigte Position
Posición lateral inclinada
Position latérale inclinée



Posizione laterale
Side position
Seitliche Position
Posición lateral
Position latérale

Impiego Use Verwendung Uso Utilisation

Si presta in modo ottimale per lavori di pulizia da ramaglie ed erbacce di argini, banchine stradali, vigneti e frutteti in genere. È utilizzabile sia in posizione centrale sia in posizione laterale da +90° a -55° di inclinazione, con spostamento laterale variabile a seconda del modello utilizzato.

It is ideal for mulching grass and twigs in ditches, on verges, embankments, and in vineyards and orchards in general. The mower can be used centrally aligned or laterally displaced and functions at any angle from +90° to -55°. Lateral movement varies according to the model.

Das TMH Seitenmulchgerät ist ideal zum Mulchen von Gras und Zweigen in Gräben und Böschungen und für die Straßenseitenreinigung. Das kann zentral ausgerichtet oder seitlich versetzt eingesetzt werden und funktioniert in jedem Winkel von +90° bis -55°. Die seitliche Bewegung variiert je nach Modell.

Esta máquina es excelente para los trabajos de limpieza de ramas y malezas de terraplenes, bordes de caminos, viñedos y plantaciones frutales en general. Se utiliza en posición central y en posición lateral y ofrece la posibilidad de trabajar con una inclinación comprendida entre +90° y -55°, con desplazamiento lateral que varía de acuerdo con el modelo utilizado.

Cet équipement est particulièrement indiqué pour l'élimination des branches mortes et des herbes hautes dans les travaux d'entretien des berges, des accotements routiers, des talus, des vignes et des vergers en général. Utilisable aussi bien en position centrale qu'en position latérale, il a une plage de travail comprise entre +90° et -55° d'inclinaison, et un déport latéral qui varie en fonction du modèle utilisé.

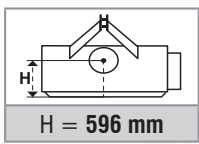

Requisiti del trattore - Tractor requirements
Traktor anforderungen - Requisitos del tractor
Exigences relatives au tracteur

Di serie
Standard
Serienmässig
Estándar
De série

mod.	cod.	cod.	rpm/min	HP	kg	cm	type	nr (type)	cm	kg
TMH 1300	1002399	1002400	540/1000	60-100	2400-3500	130	T-50 (T-70 OM)	3 (XPB 1250)	188×168×100	630
TMH 1600	1002401	1002402	540/1000	60-100	2900-4000	160	T-50 (T-70 OM)	3 (XPB 1250)	218×168×100	680
TMH 1900	1002403	1002404	540/1000	60-100	3400-4500	180	T-50 (T-70 OM)	4 (XPB 1250)	248×168×100	710
TMH 2250	1002405	1002406	540/1000	60-100	3900-5000	220	T-50 (T-70 OM)	5 (XPB 1250)	273×168×100	790
2060816			Supplemento per cardano doppio omocinetico • Surcharge for double wide angle cardan shaft • Aufpreis für doppelte Weitwinkelgelenkwelle • Recargo de transmisión cardanica con doble nudo homocinético • Supplément pour cardan double homocinétique							

Di serie	Standard equipment	Serienmässig	Estándar	De série
<ul style="list-style-type: none"> Scatola di trasmissione esterna al corpo macchina PTO 1 3/8" Z6 Cardano Rotore con sistema di taglio lineare Spostamento laterale idraulico Angolare rompitoro Slitte d'appoggio reg. in altezza Rullo ozioso posteriore regolabile in altezza (140 mm) Raschiafango per pulizia rullo ozioso Scarico anteriore rullo ozioso Cofano apribile (solo per ispezione) Telaio con doppia lamiera Protezione anteriore in gomma Protezione posteriore in gomma Protezione anteriore a catene Protezioni antinfortunistiche conformi alla normativa CE 	<ul style="list-style-type: none"> External gearbox PTO 1 3/8" Z6 PTO drive shaft Rotor with linear cutting system Hydraulic side shift Corner reinforcement for shredding material Height-adjustable skids Rear levelling roller height adjustable (140 mm) Scraper for rear levelling roller Discharge of the material over the levelling roller Opening hood (for inspection only) Double skinned frame Front protection with rubber Rear protection with rubber Front protection with chains Protective equipment as per EC safety rules 	<ul style="list-style-type: none"> Getriebe außenliegend PTO 1 3/8" Z6 Gelenkwelle Rotor mit linear Schnittsystem Hydraulische Seitenverschiebung Eckenverstärkung für Zerkleinerungsmaterial Höhenverstellbare Stützkufen Hintere Stützwalze höhenverstellbar (140 mm) Walzenabstreifer Entladung des Materials über die Walze Heckhaube (darf nur für Wartungsarbeiten geöffnet werden) Doppelwandiger Rahmen Frontschutz mit Gummileiste Hinterer Gummischutz Frontschutz mit Ketten Unfallschutz nach EU-Vorschriften 	<ul style="list-style-type: none"> Caja de engranajes montada externamente en el bastidor de la máquina, TDF 1 3/8" Z6 Transmisión cardanica Rotor con sistema de corte lineal Desplazamiento lateral hidr. Rompedor angular Patines de apoyo reg. en altura Rodillo nivelador trasero (140 mm), con regulación en altura Limpiador montado en el rodillo nivelador trasero Descarga ant. al rodillo nivelador Portón trasero aperturable (solo para inspección) Interior del cuerpo de maquina, con doble chapa Protección frontal en goma Protección posterior en goma Protección anterior a cadenas Protecciones de seguridad de acuerdo con la norma CE 	<ul style="list-style-type: none"> Boîtier de transmission externe au châssis de la machine PDF 1 3/8" Z6 Cardan Rotor avec syst. de coupe linéaire Déport latéral hydraulique Barre brisante Patins d'appui réglables en hauteur Rouleau d'appui arrière réglable en hauteur (140 mm) Racleur pour le rouleau d'appui Ejection devant le rouleau d'appui Capot ouvrant (pour inspection seulement) Caisson renf. par blindage interne Protection avant en caoutchouc Protection arrière en caoutchouc Protection avant avec chaînes Protections contre les accidents aux normes CE

TMH	OFF-SET MULCHER MEDIUM DUTY WITH EXTERNAL GEARBOX
TMH	SEITENMULCHER MITTELSCHWERE AUSFÜHRUNG MIT EXTERNEM GETRIEBE
TMH	TRITURADORA PARA RIBERAS PESADA - CAJA DE TRANSMISIÓN EXTERIOR
TMH	BROYEUR D'ACCOTEMENT LOURD - BÔTE DE TRANSMISSION EXTÉRIEURE

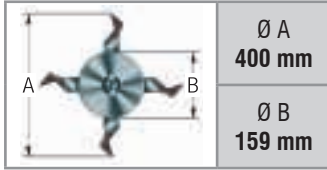

Ø A
400 mm

Ø B
159 mm

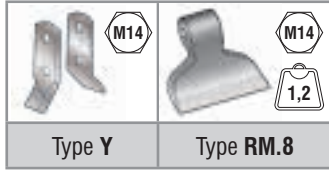

Type Y

Type RM.8

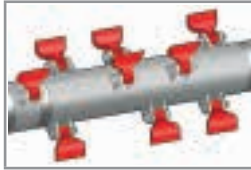

Sistema di taglio lineare
Linear cutting system
Linearrotoir
Sistema de corte lineal
Système de coupe linéaire



MOVEMENT MACHINE

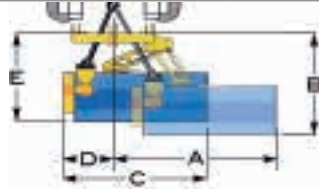

WORKING WIDTH

Standard



mod.	A	B	C	D	E
TMH 1300	240	228	188	96	168
TMH 1600	270	228	218	96	168
TMH 1900	300	228	248	96	168
TMH 2250	330	228	278	96	168

cm	nr	nr
130	32	16
160	40	20
190	48	24
225	56	28

cod.	A richiesta	On request	Auf Anfrage	Opcionales	Sur demande
5130013	Cardano T-70 OM omocinetico	Double wide angle PTO shaft T-70 OM	Doppelte Weitwinkelgelenkwelle T-70 OM	Cardán T-70 OM homocinetico	Cardan T-70 OM homocinétique
2051283	Sistema auto-livellamento trincia	Mulcher self-levelling system	Mulcher-Selbstnivellierungssystem	Sistema autonivelante trituradora	Système de nivellement automatique

cod.	Ricambi	Spare parts	Ersatzteile	Recambios	Pièces de rechange
5354003	Cinghia XPB 1250	Cug belt XPB 1250	Keilriemen XPB 1250	Correa XPB 1250	Courroie XPB 1250
5315011	Vite M14 per utensile	M14 screw for tool	M14 Schraube für Werkzeug	Tornillo M14 para herramienta	Vis M14 pour outil
5323016	Dado M14 per utensile	M14 nut for tool	M14 Mutter für Werkzeug	Tuerca M14 para herramienta	Ecrou M14 pour outil
5350024	Mazza RM.8	Hammer RM.8	Hammer RM.8	Martillo RM.8	Marteau RM.8
5350040	Coltello "Y"	"Y" blade	"Y" Messer	Cuchilla "Y"	Couteau "Y"
5130008	Cardano T-50	PTO shaft T-50	Gelenkwelle T-50	Cardán T-50	Cardan T-50
2020048	Scatola trasmissione	Gear box	Getriebe	Caja de engranajes	Boîtier de transmission

SISTEMA ANTISHOCK



Consente l'attenuazione dell'urto tra trincia argini ed eventuali sassi o ostacoli durante il taglio, ciò permette l'utilizzo della trincia anche in terreni rocciosi o accidentati.

Allows attenuation of impact between verge and any stones or obstacles when cutting, which allows the use of mulches in rocky or uneven terrain

Ermöglicht Dämpfung des Aufpralls zwischen Schwelle und alle Steine oder beim Schneiden, die die Verwendung von Laubdeck in in felsigen oder unebenem Gelände ermöglicht Hindernisse

Permite la atenuación del impacto entre el borde y las piedras u obstáculos al corte, que permite el uso de coberturas en terreno rocoso o irregular

Permet l'atténuation de l'impact entre point et toutes les pierres ou des obstacles lors de la coupe, ce qui permet l'utilisation de paillis en terrain rocheux ou inégal

SISTEMA FLOTTANTE

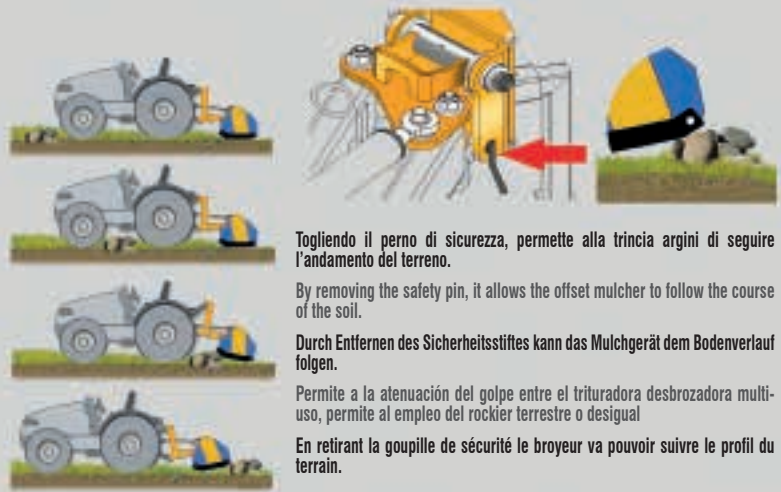

Togliendo il perno di sicurezza, permette alla trincia argini di seguire l'andamento del terreno.

By removing the safety pin, it allows the offset mulcher to follow the course of the soil.

Durch Entfernen des Sicherheitsstiftes kann das Mulchgerät dem Bodenverlauf folgen.

Permite a la atenuación del golpe entre el trituradora desbrozadora multi-uso, permite al empleo del rockier terrestre o desigual

En retirant la goupille de sécurité le broyeur va pouvoir suivre le profil du terrain.



Trasporto su strada
Road transport
Straßentransport
Transporte en carretera
Transport sur route



Posizione laterale verticale
Vertical side position
Senkrechte Position
Posición lateral vertical
Position latérale verticale



Posizione laterale inclinata
Inclined side position
Geneigte Position
Posición lateral inclinada
Position latérale inclinée



Versione sinistra
Left hand version
Linke Ausführung
Versión izquierda
Version gauche

ON REQUEST

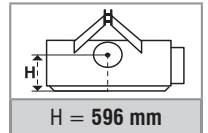
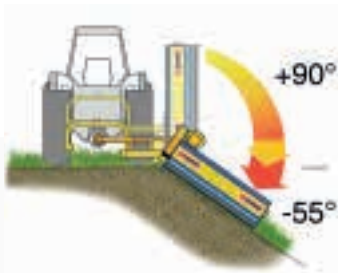

Di serie
Standard
Serienmässig
Estándar
De série

Inclinazione trincia
Inclination schredder
Neigungswinkel Mulchers
Inclinación trituradora
Inclinaison broyeur

Scarico anteriore al rullo:
migliore trinciatura
Front discharge to the roller:
better shredding
Ablage vor der Laufwalze:
Bessere Zerkleinerung
Descarga frontal al rodillo:
mejor trituración
Déchargement antérieur au
rouleau: meilleur broyage

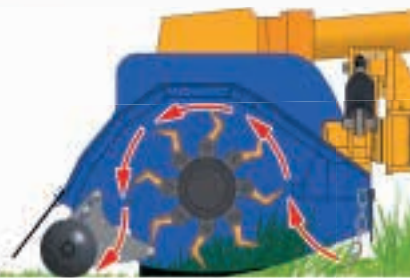

Scarico posteriore al rullo:
meno potenza richiesta
Rear discharge to the roller:
less power required
Ablage nach der Laufwalze:
Weniger Kraftbedarf
Descarga trasera del rodillo:
menos potencia requerida
Déchargement arrière au rouleau:
moins de puissance nécessaire



Requisiti del trattore - Tractor requirements
Traktor anforderungen - Requisitos del tractor
Exigences relatives au tracteur



mod.	cod.	cod.	rpm/min	HP	kg	cm	type	nr (type)	cm	kg
TMH-PRO 1400	1003678	1003672	540/1000	70-120	2500-4000	140	T-50 (T-70 OM)	4 (XPB)	190×168×100	680
TMH-PRO 1600	1003679	1003673	540/1000	70-120	3000-4500	160	T-50 (T-70 OM)	4 (XPB)	218×168×100	735
TMH-PRO 1800	1003680	1003674	540/1000	70-120	3500-5000	180	T-50 (T-70 OM)	4 (XPB)	238×168×100	790
TMH-PRO 2000	1003681	1003675	540/1000	70-120	3000-5500	200	T-50 (T-70 OM)	4 (XPB)	258×168×100	820
TMH-PRO 2200	1003682	1003676	540/1000	70-120	4500-6000	220	T-50 (T-70 OM)	5 (XPB)	293×168×100	840

2060816

Supplemento per cardano doppio omocinetico • Surcharge for double wide angle cardan shaft • Aufpreis für doppelte Weitwinkelgelenkwelle • Recargo de transmisión cardanica con doble nudo homocinetico • Supplément pour cardan double homocinétique

Di serie	Standard equipment	Serienmässig	Estándar	De série
<ul style="list-style-type: none"> Scatola di trasmissione esterna al corpo macchina PTO 1 3/8" Z6 Cardano Rotore con sistema di taglio elicoidale Spostamento laterale idraulico Angolare rompitore Slitte d'appoggio reg. in altezza Rullo ozioso posteriore regolabile in altezza (160 mm) Lamiera antiusura su scocca Fiancata destra con bordi arrotondati Scarico anteriore/posteriore rullo ozioso Protezione posteriore in gomma Protezione anteriore a catene Protezioni antinfortunistiche conformi alla normativa CE 	<ul style="list-style-type: none"> External gearbox PTO 1 3/8" Z6 PTO drive shaft Rotor with helical cutting system Hydraulic side shift Corner reinforcement for shredding material Height-adjustable skids Rear levelling roller height adjustable (160 mm) Wear plate on body Right side rounded shoulder Discharge of the material front/rear of the rear levelling roller Rear protection with rubber Front protection with chains Protective equipment as per EC safety rules 	<ul style="list-style-type: none"> Getriebe außenliegend PTO 1 3/8" Z6 Gelenkwelle Spiralrotor Hydraulische Seitenverschiebung Eckenverstärkung für Zerkleinerungsmaterial Höhenverstellbare Stützkufen Hintere Stützwalze höhenverstellbar (160 mm) Verschleißplatte am Gehäuse Abgerundete rechte Seitenecke Abladen des gehäckselten Gutes vor oder über der Stützwalze Hinterer Gummischutz Frontschutz mit Ketten Unfallschutz nach EU-Vorschriften 	<ul style="list-style-type: none"> Caja de engranajes montada externamente en el bastidor de la máquina, TDF 1 3/8" Z6 Transmisión cardanica Rotor con sist. de corte helicoidal Desplazamiento lateral hidr. Rompedor angular Patines de apoyo reg. en altura Rodillo nivelador trasero (160 mm), con regulación en altura Placa anti desgaste sur el cuerpo Lateral derecho con borde redondeado Descarga ant./post. al rodillo nivelador Protección posterior en goma Protección anterior a cadenas Protecciones de seguridad de acuerdo con la norma CE 	<ul style="list-style-type: none"> Boîtier de transmission externe au châssis de la machine PDF 1 3/8" Z6 Cardan Rotor avec système de coupe hélicoïdal Déport latéral hydraulique Barre brisante Patins d'appui réglables en hauteur Rouleau d'appui arrière réglable en hauteur (160 mm) Plaque anti-usure sur le corps Côté latéral droit arrondi Ejection devant/arrière le rouleau d'appui Protection arrière en caoutchouc Protection avant avec chaînes Protections contre les accidents aux normes CE

TMH-PRO	OFF-SET MULCHER MEDIUM DUTY WITH EXTERNAL GEARBOX
TMH-PRO	SEITENMULCHER MITTELSCHWERE AUSFÜHRUNG MIT EXTERNEM GETRIEBE
TMH-PRO	TRITURADORA PARA RIBERAS PESADA - CAJA DE TRANSMISIÓN EXTERIOR
TMH-PRO	BROYEUR D'ACCOTEMENT LOURD - BÔTE DE TRANSMISSION EXTÉRIEURE

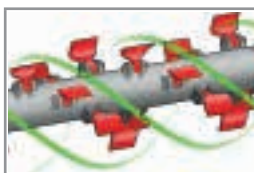
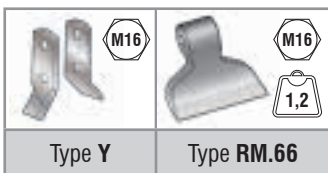
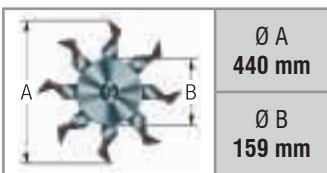

Sistema di taglio elicoidale
Helical cutting system
Spiralrotor
Sistema de corte helicoidal
Système de coupe hélicoïdal



MOVEMENT MACHINE

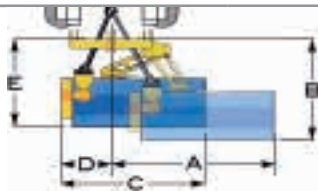

WORKING WIDTH

Standard



cm	nr	nr
140	36	18
160	40	20
180	48	24
200	48	24
220	56	28

mod.	A	B	C	D	E
TMH-PRO 1400	267	235	202	100	190
TMH-PRO 1600	286	235	221	100	190
TMH-PRO 1800	305	235	240	100	190
TMH-PRO 2000	324	235	259	100	190
TMH-PRO 2200	343	235	278	100	190

cod.	A richiesta	On request	Auf Anfrage	Opcionales	Sur demande
5130013	Cardano T-70 OM omocinetico	Double wide angle PTO shaft T-70 OM	Doppelte Weitwinkelgelenkwelle T-70 OM	Cardán T-70 OM homocinetico	Cardan T-70 OM homocinétique

SISTEMA ANTISHOCK



Consente l'attenuazione dell'urto tra trincia argini ed eventuali sassi o ostacoli durante il taglio, ciò permette l'utilizzo del trincia anche in terreni rocciosi o accidentati.

Allows attenuation of impact between verge and any stones or obstacles when cutting, which allows the use of mulches in rocky or uneven terrain

Ermöglicht Dämpfung des Aufpralls zwischen Schwelle und alle Steine oder beim Schneiden, die die Verwendung von Laubdeck in in felsigen oder unebenem Gelände ermöglicht Hindernisse

Permite la atenuación del impacto entre el borde y las piedras u obstáculos al corte, que permite el uso de coberturas en terreno rocoso o irregular

Permet l'atténuation de l'impact entre point et toutes les pierres ou des obstacles lors de la coupe, ce qui permet l'utilisation de pailles en terrain rocheux ou inégale

SISTEMA FLOTTANTE

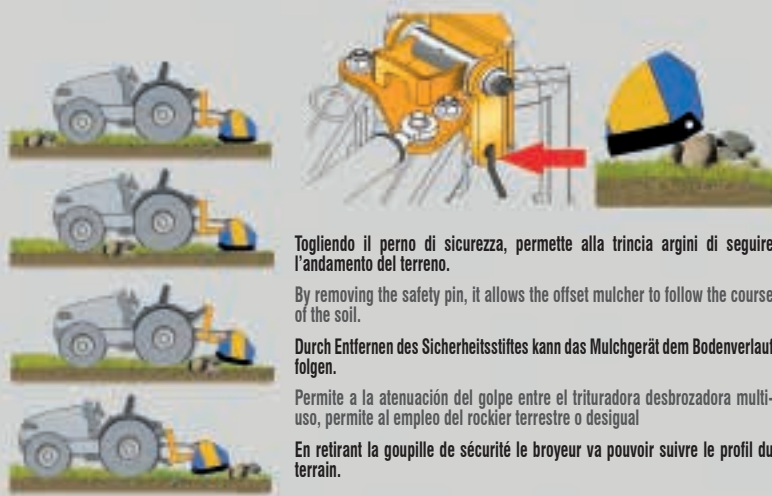

Togliendo il perno di sicurezza, permette alla trincia argini di seguire l'andamento del terreno.

By removing the safety pin, it allows the offset mulcher to follow the course of the soil.

Durch Entfernen des Sicherheitsstiftes kann das Mulchgerät dem Bodenverlauf folgen.

Permite a la atenuación del golpe entre el trituradora desbrozadora multi-uso, permite al empleo del rockier terrestre o desigual

En retirant la goupille de sécurité le broyeur va pouvoir suivre le profil du terrain.



Sistema auto-livellamento trincia con catena di sicurezza
Mulcher self-levelling system with safety chain
Mulcher-Selbstnivellierungssystem mit Sicherheitsketten
Sistema autonivelante trituradora con cadena de seguridad
Système auto-nivelant du broyeur avec chaîne de sécurité



Scatola di trasmissione esterna al corpo macchina
External gearbox
Getriebe außenliegend
Caja de engranajes montada externamente en el bastidor de la máquina
Boîtier de transmission externe au châssis de la machine



Trasporto su strada
Road transport
Straßentransport
Transporte en carretera
Transport sur route



Posizione laterale verticale
Vertical side position
Senkrechte Position
Posición lateral vertical
Position latérale verticale



Posizione laterale
Side position
Seitliche Position
Posición lateral
Position latérale



Posizione laterale inclinata
Inclined side position
Geneigte Position
Posición lateral inclinada
Position latérale inclinée

TMH-PRO

Impiego

Si presta in modo ottimale per lavori di pulizia da ramaglie ed erbacce di argini, banchine stradali, vigneti e frutteti in genere. È utilizzabile sia in posizione centrale sia in posizione laterale da +90° a -55° di inclinazione, con spostamento laterale variabile a seconda del modello utilizzato.

Use

It is ideal for mulching grass and twigs in ditches, on verges and embankments. The mulcher can be used centrally aligned or laterally displaced and functions at any angle from +90° to -55°. Lateral movement varies according to the model.

Verwendung

Das TMA-S Seitenmulchgerät ist eine schwere Ausführung, ideal zum Mulchen von Gras und Zweigen in Gräben, und Böschungen. Das kann zentral ausgerichtet oder seitlich versetzt eingesetzt werden und funktioniert in jedem Winkel von +90° bis -55°. Die seitliche Bewegung variiert je nach Modell.

Uso

Esta máquina es excelente para los trabajos de limpieza de ramas y malezas de terraplenes, bordes de caminos, viñedos y plantaciones frutales en general. Se utiliza en posición central y en posición lateral y ofrece la posibilidad de trabajar con una inclinación comprendida entre +90° y -55°, con desplazamiento lateral que varía de acuerdo con el modelo utilizado.

Utilisation

Cet équipement est particulièrement indiqué pour l'élimination des branches mortes et des herbes hautes dans les travaux d'entretien des berges, des accotements routiers, des talus, des vignes et des vergers en général. Utilisable aussi bien en position centrale qu'en position latérale, il a une plage de travail comprise entre +90° et -55° d'inclinaison, et un déport latéral qui varie en fonction du modèle utilisé.

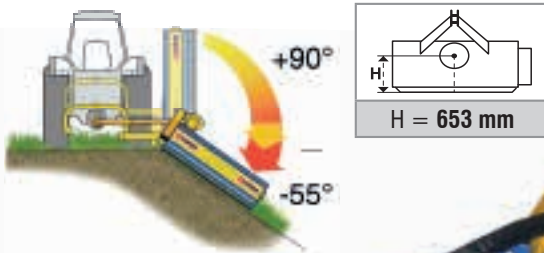
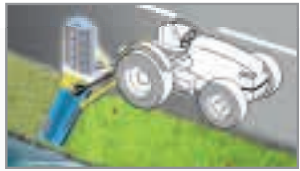

Inclinazione trincia
Inclination schredder
Neigungswinkel Mulchers
Inclinación trituradora
Inclinaison broyeur

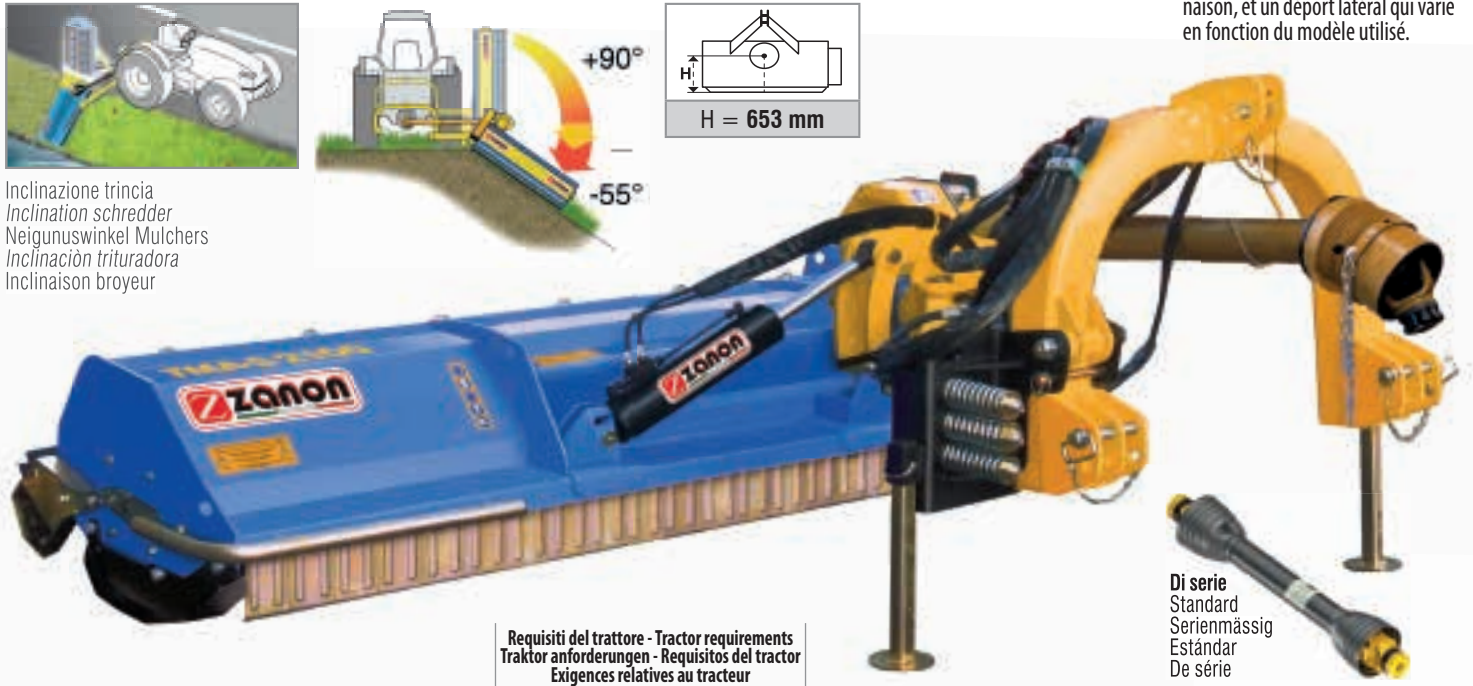

Di serie
Standard
Serienmässig
Estándar
De série

Requisiti del trattore - Tractor requirements
Traktor anforderungen - Requisitos del tractor
Exigences relatives au tracteur

mod.	cod.	cod.	rpm/min	HP	kg	cm	type	nr (type)	cm	kg
TMA-S 2100	1002816	1002813	540/1000	100-150	5500/7500	180	T-80 OM	6 (XPB 1500)	265×210×116	1095
TMA-S 2300	1002817	1002814	540/1000	100-150	6000/8000	200	T-80 OM	6 (XPB 1500)	286×210×116	1130
TMA-S 2500	1002818	1002815	540/1000	100-150	6500/8500	220	T-80 OM	6 (XPB 1500)	316×210×116	1200

Di serie	Standard equipment	Serienmässig	Estándar	De série
<ul style="list-style-type: none"> Scatola di trasmissione esterna al corpo macchina PTO 1 3/4" Z6 Cardano doppio omocinetico Rotore con sistema di taglio lineare Spostamento laterale idraulico Doppia fila di pettini rompitori Slitte d'appoggio regolabili in altezza Rullo ozioso posteriore regolabile in altezza (194 mm) Raschifango per pulizia rullo ozioso Scarico anteriore rullo ozioso Cofano apribile (solo per ispezione) Telaio con doppia lamiera Protezione anteriore a bandinelle Protezioni antinfortunistiche conformi alla normativa CE 	<ul style="list-style-type: none"> External gearbox PTO 1 3/4" Z6 Double wide angle cardan shaft Rotor with linear cutting system Hydraulic side shift Double row counter-blades Height-adjustable skids Rear levelling roller height adjustable (194 mm) Scraper for rear levelling roller Discharge of the material over the levelling roller Opening hood (for inspection only) Double skinned frame Front protection with metal flaps Protective equipment as per EC safety rules 	<ul style="list-style-type: none"> Getriebe außenliegend PTO 1 3/4" Z6 Doppelte Weitwinkelgelenkwelle Rotor mit linear Schnittsystem Hydraulische Seitenverschiebung 2 Reihen Gegenschneide Höhenverstellbare Stützkufen Hintere Stützwalze höhenverstellbar (194 mm) Walzenabstreifer Entladung des Materials über die Walze Heckhaube (darf nur für Wartungsarbeiten geöffnet werden) Doppelwandiger Rahmen Frontschutz mit Metallklappen Unfallschutz nach EU-Vorschriften 	<ul style="list-style-type: none"> Caja de engranajes montada externamente en el bastidor de la máquina, TDF 1 3/4" Z6 Transmisión cardanica con doble nudo homocinetico Rotor con sistema de corte lineal Desplazamiento lateral hidrául. Doble fila de rompedores Patines de apoyo reg. en altura Rodillo nivelador trasero (194 mm), con regulación en altura Limpiador montado en el rodillo nivelador trasero Descarga anterior al rodillo nivelador Portón trasero aperturable (solo para inspección) Interior del cuerpo de maquina, con doble chapa Protección delantera mediante placas metálicas Protecciones de seguridad de acuerdo con la norma CE 	<ul style="list-style-type: none"> Boîtier de transmission externe au châssis de la machine PDF 1 3/8" Z6 Cardan homocinétique double Rotor avec système de coupe linéaire Déport latéral hydraulique Double rangée de peignes Patins d'appui réglables en hauteur Rouleau d'appui arrière réglable en hauteur (194 mm) Racleur pour le rouleau d'appui Ejection devant le rouleau d'appui Capot ouvrant (pour inspection seulement) Caisson renforcé par blindage interne Protection avant avec volets métalliques Protections contre les accidents aux normes CE

TMA-S	OFF-SET MULCHER EXTRA HEAVY DUTY WITH EXTERNAL GEARBOX
TMA-S	SEITENMULCHER MITTELSCHWERE AUSFÜHRUNG MIT EXTERNEM GETRIEBE
TMA-S	TRITURADORA PARA RIBERAS PESADA - CAJA DE TRANSMISIÓN EXTERIOR
TMA-S	BROYEUR D'ACCOTEMENT LOURD - BÔTE DE TRANSMISSION EXTÉRIEURE

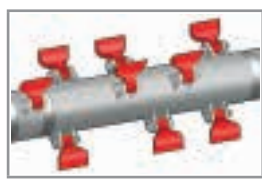
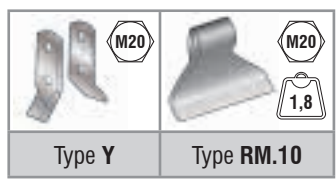
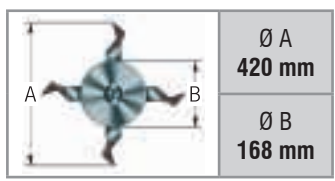

Sistema di taglio lineare
Linear cutting system
Linearroter
Sistema de corte lineal
Système de coupe linéaire



MOVEMENT MACHINE

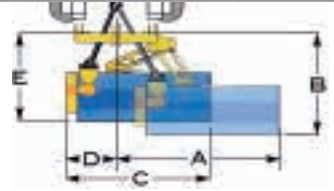

mod.	A	B	C	D	E
TMA-S 2100	327	219	275	67	206
TMA-S 2300	349	219	297	67	206
TMA-S 2500	379	219	327	67	206

WORKING WIDTH	Standard	
	nr	nr
210	54	18
230	60	20
250	60	22

cod.	Ricambi	Spare parts	Ersatzteile	Recambios	Pièces de rechange
5354044	Cinghia XPB 1500	Cug belt XPB 1500	Keilriemen XPB 1500	Correa XPB 1500	Courroie XPB 1500
5315093	Vite M20 per utensile	M20 screw for tool	M20 Schraube für Werkzeug	Tornillo M20 para herramienta	Vis M20 pour outil
5323018	Dado M20 per utensile	M20 nut for tool	M20 Mutter für Werkzeug	Tuerca M20 para herramienta	Ecrou M20 pour outil
5350038	Mazza RM.10	Hammer RM.10	Hammer RM.10	Martillo RM.10	Marteau RM.10
5350040	Coltello "Y"	"Y" blade	"Y" Messer	Cuchilla "Y"	Couteau "Y"
5130050	Cardano T-80 OM omocinetico	Double wide angle PTO shaft T-80 OM	Doppelte Weitwinkelgelenkwelle T-80 OM	Cardán T-80 OM homocinetico	Cardan T-80 OM homocinétique
2020124	Scatola trasmissione	Gear box	Getriebe	Caja de engranajes	Boîtier de transmission

SISTEMA ANTISHOCK

Blocco sicurezza molle per il trasporto
Springs holder for Transport
Sicherheitsblock Straßentransport
Bloqueo de seguridad para transporte
Verrouillage de sécurité à ressort pour le transport

Consente l'attenuazione dell'urto tra trincia argini ed eventuali sassi o ostacoli durante il taglio, ciò permette l'utilizzo del trincia anche in terreni rocciosi o accidentati.
Allows attenuation of impact between verge and any stones or obstacles when cutting, which allows the use of mulches in rocky or uneven terrain
Ermöglicht Dämpfung des Aufpralls zwischen Schwelle und alle Steine oder beim Schneiden, die die Verwendung von Laubdecke in in felsigen oder unebenem Gelände ermöglicht Hindernisse
Permite la atenuación del impacto entre el borde y las piedras u obstáculos al corte, que permite el uso de coberturas en terreno rocoso o irregular
Permet l'atténuation de l'impact entre point et toutes les pierres ou des obstacles lors de la coupe, ce qui permet l'utilisation de paillis en terrain rocheux ou inégale

SISTEMA FLOTTANTE

Perno da rimuovere durante il lavoro
Pin to remove in work
Bolzen nur während der Arbeit wegnehmen
Remove el perno durante el trabajo
Pivot à enlever pendant le travail

Togliendo il perno di sicurezza, permette alla trincia argini di seguire l'andamento del terreno.
By removing the safety pin, it allows the offset mulcher to follow the course of the soil.
Durch Entfernen des Sicherheitsstiftes kann das Mulchgerät dem Bodenverlauf folgen.
Permite a la atenuación del golpe entre el trituradora desbrozadora multi-uso, permite al empleo del rockier terrestre o desigual
En retirant la goupille de sécurité le broyeur va pouvoir suivre le profil du terrain.



Trasporto su strada
Road transport
Straßentransport
Transporte en carretera
Transport sur route

Posizione laterale verticale
Vertical side position
Senkrechte Position
Posición lateral vertical
Position latérale verticale

Posizione laterale inclinata
Inclined side position
Geneigte Position
Posición lateral inclinada
Position latérale inclinée

Posizione laterale
Side position
Seitliche Position
Posición lateral
Position latérale

TMA-S

Impiego Use Verwendung Uso Utilisation

Si presta in modo ottimale per lavori di pulizia da ramaglie ed erbacce di argini e banchine stradali. È utilizzabile sia in posizione centrale sia in posizione laterale da +90° a -60° di inclinazione, con spostamento laterale variabile a seconda del modello utilizzato.





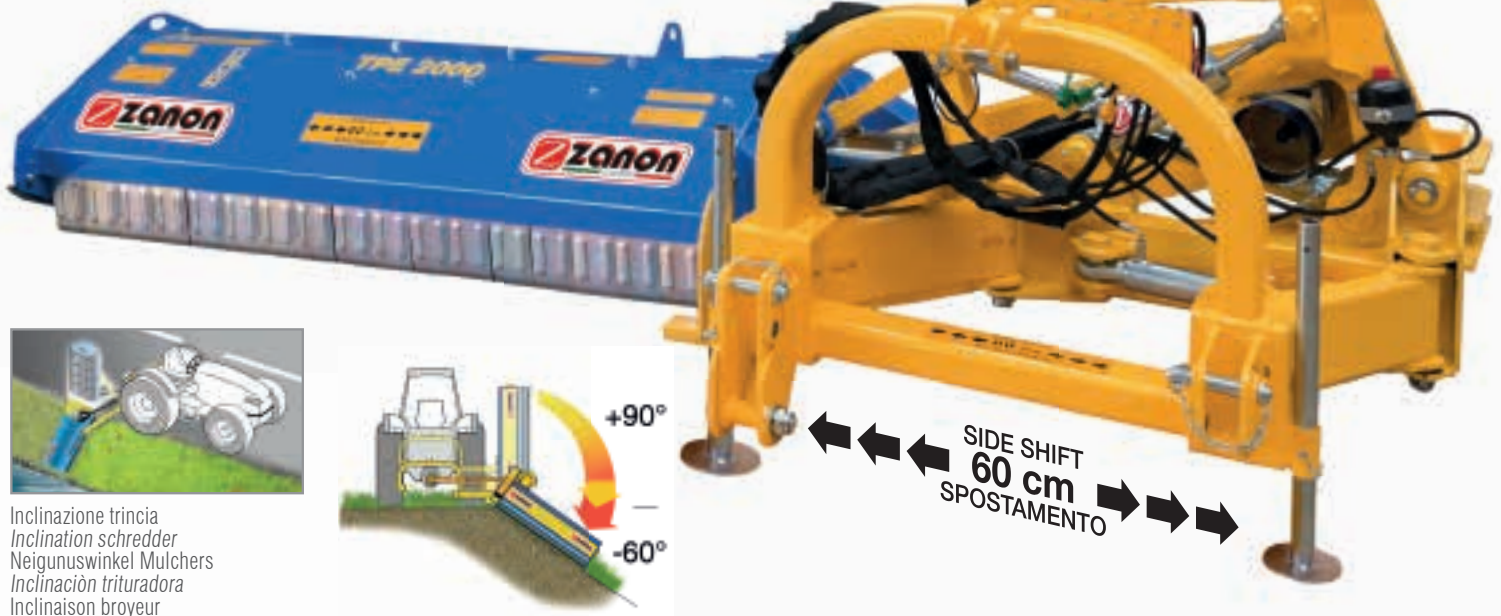
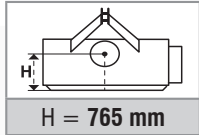

It is ideal for mulching grass and twigs in ditches, on verges and embankments. The mower can be used centrally aligned or laterally displaced and functions at any angle from +90° to -60°. Lateral movement varies according to the model.

Das TPE Seitenmulchgerät mit Parallelogramm-Technik ist eine schwere Ausführung, ideal zum Mulchen von Gras und Zweigen in Gräben und Böschungen und für die Straßenseitenreinigung. Das kann nur seitlich versetzt eingesetzt werden und funktioniert in jedem Winkel von +90° bis -60°. Die seitliche Bewegung variiert je nach Modell.

Esta máquina es excelente para los trabajos de limpieza de ramas y malezas de terraplenes y bordes de caminos. Se utiliza en posición central y en posición lateral y ofrece la posibilidad de trabajar con una inclinación comprendida entre +90° y -60°, con desplazamiento lateral que varía de acuerdo con el modelo utilizado.

Cet équipement est particulièrement indiqué pour l'élimination des branches mortes et des herbes hautes dans les travaux d'entretien des berges et des accotements routiers. Utilisable aussi bien en position centrale qu'en position latérale, il a une plage de travail comprise entre +90° et -60° d'inclinaison, et un déport latéral qui varie en fonction du modèle utilisé.

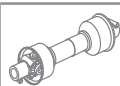
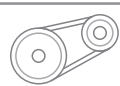

									
mod.	cod.	cod.	HP	kg	rpm/min	type	nr (type)	cm	kg
TPE 2000	1002652	1002649	90 - 150	3500	540	T-60	5 (SPB 2650)	218×168×100	1100
TPE 2200	1002653	1002650	100 - 150	3800	540	T-60	5 (SPB 2650)	248×168×100	1170

Di serie	Standard equipment	Serienmässig	Estándar	De série
<ul style="list-style-type: none"> Scatola di trasmissione esterna al corpo macchina PTO 1 3/8" Z6 Rotore con sistema di taglio elicoidale Spostamento laterale idraulico Singola fila di pettini rompitori Slitte d'appoggio regolabili in altezza Rullo ozioso posteriore regolabile in altezza (194 mm) Scarico posteriore rullo ozioso Accumulatore oleopneumatico Telaio con doppia lamiera Protezione posteriore in gomma Protezione anteriore a bandinelle Protezioni antinfortunistiche conformi alla normativa CE 	<ul style="list-style-type: none"> External gearbox PTO 1 3/8" Z6 Rotor with helical cutting system Hydraulic side shift Single row counter-blades Height-adjustable skids Rear levelling roller height adjustable (194 mm) Discharge of the material before the levelling roller Hydropneumatic accumulator Double skinned frame Rear protection with rubber Front protection with metal flaps Protective equipment as per EC safety rules 	<ul style="list-style-type: none"> Getriebe außenliegend PTO 1 3/8" Z6 Spiralrotor Hydraulische Seitenverschiebung 1 Reihe Gegenschneide Höhenverstellbare Stützkufen Hinterer Stützwalze höhenverstellbar (194 mm) Entladung des Materials vor der Walze Hydropneumatische Druckspeicher Doppelwandiger Rahmen Hinterer Gummischutz Frontschutz mit Metallklappen Unfallschutz nach EU-Vorschriften 	<ul style="list-style-type: none"> Caja de engranajes montada externamente en el bastidor de la máquina, TDF 1 3/8" Z6 Rotor con sist. de corte helicoidal Desplazamiento lateral hidrául. Rompedor Patines de apoyo reg. en altura Rodillo nivelador trasero (194 mm), con regulación en altura Descarga posterior al rodillo nivelador Acumulador hidroneumático Interior del cuerpo de máquina, con doble chapa Protección posterior en goma Protección delantera mediante placas metálicas Protecciones de seguridad de acuerdo con la norma CE 	<ul style="list-style-type: none"> Boîtier de transmission externe au châssis de la machine PDF 1 3/8" Z6 Rotor avec système de coupe hélicoïdal Déport latéral hydraulique Simple rangée de peignes Patins d'appui réglables en hauteur Rouleau d'appui arrière réglable en hauteur (194 mm) Ejection derrière le rouleau d'appui Accumulateur oléopneumatique Caisson renf. par blindage interne Protection arrière en caoutchouc Protection avant avec volets métalliques Protections contre les accidents aux normes CE

TPE	OFF-SET MULCHER HEAVY DUTY WITH PARALLELOGRAM SIDE SHIFT
TPE	SEITENMULCHER SCHWERE AUSFÜHRUNG MIT PARALLELOGRAM
TPE	TRITURADORA PARA RIBERAS - DESPLAZAMIENTO LATERAL MEDIANTE PARALELOGRAMO
TPE	BROYEUR D'ACCOTEMENT LOURD - DÉPORT LATÉRAL À PARALLÉOGRAMME

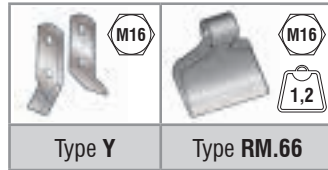
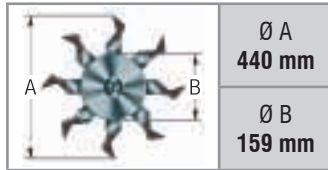

Sistema di taglio elicoidale
 Helical cutting system
 Spiralrotor
 Sistema de corte helicoidal
 Système de coupe hélicoïdal



MOVEMENT MACHINE

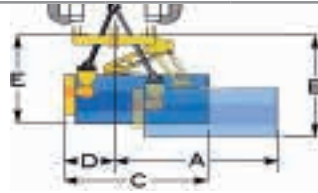

WORKING WIDTH

Standard



mod.	A	B	C	D	E
TPE 2000	335	148	357	82	154
TPE 2200	354	148	375	82	154

cm	nr	nr
200	48	24
220	56	28

cod.	A richiesta	On request	Auf Anfrage	Opcionales	Sur demande
5130036	Cardano T-60	PTO shaft T-60	Gelenkwelle T-60	Cardán T-60	Cardan T-60

cod.	Ricambi	Spare parts	Ersatzteile	Recambios	Pièces de rechange
5354084	Cinghia SPB 2650	Cug belt SPB 2650	Keilriemen SPB 2650	Correa SPB 2650	Courroie SPB 2650
5315446	Vite M16 per utensile	M16 screw for tool	M16 Schraube für Werkzeug	Tornillo M16 para herramienta	Vis M16 pour outil
5323017	Dado M16 per utensile	M16 nut for tool	M16 Mutter für Werkzeug	Tuerca M16 para herramienta	Ecrou M16 pour outil
5350121	Mazza RM.66	Hammer RM.66	Hammer RM.66	Martillo RM.66	Marteau RM.66
5350127	Coltello "Y"	"Y" blade	"Y" Messer	Cuchilla "Y"	Couteau "Y"
2020095	Scatola trasmissione	Gear box	Getriebe	Caja de engranajes	Boîtier de transmission



Accumulatore oleopneumatico
 Hydropneumatic accumulator
 Hydropneumatische Druckspeicher
 Acumulador hidroneumático
 Accumulateur oléopneumatique



Freno di sicurezza per trasporto su strada
 Safety pin for road transport
 Sicherheitsstift für den Straßentransport
 Pin de seguridad para el transporte por carretera
 Pin de securite pour le transport routier

SISTEMA ANTISHOCK



Consente l'attenuazione dell'urto tra trincia argini ed eventuali sassi o ostacoli durante il taglio, ciò permette l'utilizzo del trincia anche in terreni rocciosi o accidentati.

Allows attenuation of impact between verge and any stones or obstacles when cutting, which allows the use of mulches in rocky or uneven terrain

Ermöglicht Dämpfung des Aufpralls zwischen Schwelle und alle Steine oder beim Schneiden, die die Verwendung von Laubdeck in in felsigen oder unebenem Gelände ermöglicht Hindernisse

Permite la atenuación del impacto entre el borde y las piedras u obstáculos al corte, que permite el uso de coberturas en terreno rocoso o irregular

Permet l'atténuation de l'impact entre point et toutes les pierres ou des obstacles lors de la coupe, ce qui permet l'utilisation de paillis en terrain rocheux ou inégale



Trasporto su strada
 Road transport
 Straßentransport
 Transporte en carretera
 Transport sur route



Posizione laterale inclinata
 Inclined side position
 Geneigte Position
 Posición lateral inclinada
 Position latérale inclinée

KIT FARI WIRELESS ANTERIORE



wireless

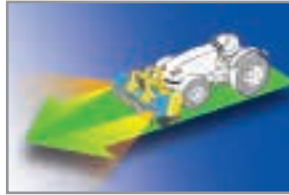

Wireless, magnetico, omologato

Funziona con 12 V e 24 V.

Funzioni: posizione / indicatore lampeggiante

Distanza massima di trasmissione fino a 20 metri.

WIRELESS LED

Front LED headlights kit

Wireless, magnetic, homologated

Works with 12 V and 24 V.

Functions: position / Indicator

Maximum transmitting distance 20 meters.

Kabelloser Blinker mit Begrenzungsleuchte für vorne

Kabelloses, magnetisch, zugelassen

Arbeitet mit 12 V und 24 V.

Funktionen: Positionsleuchte / Blinker

Maximale Übertragungsentfernung 20 Meter

Kit de intermitentes con luz de posición delantera con soporte magnético y homologado.

Funciona con 12 V y 24 V.

Funciones: posición / intermitente

Distancia de transmisión máxima hasta 20 metros

Kit clignotant avec feu de position avant magnétiques sans fil homologués

Fonctionne avec 12 V et 24 V.

Fonctions: position / clignotant

Distance maximale de transmission 20 mètres



rif.	cod.
1 Kit	2050893

KIT FARI WIRELESS POSTERIORE



wireless

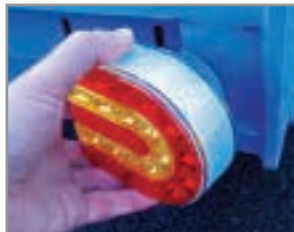
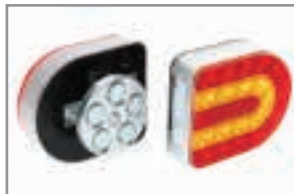
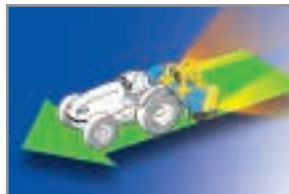

Wireless, magnetico, omologato

Funziona con 12 V e 24 V.

Funzioni: freno / posizione / indicatore / targa.

Distanza massima di trasmissione fino a 20 metri.

WIRELESS LED

Rear LED light kit

Wireless, magnetic, homologated

Works with 12 V and 24 V.

Functions: brake / tail / indicator / number plate

Maximum transmitting distance 20 meters.

LED-Rücklicht-Kit

Kabelloses, magnetisch, zugelassen

Arbeitet mit 12 V und 24 V.

Funktionen: Bremse/Heck/Bake/Kennzeichen

Maximale Übertragungsentfernung 20 Meter

Kit de luces LED traseras del tipo inalámbrico, con soporte magnético y homologado.

Funciona con 12 V y 24 V.

Funciones: freno / trasero / intermitente / matrícula

Distancia de transmisión máxima hasta 20 metros

Kit de feux arrière à LED magnétiques sans fil homologués

Fonctionne avec 12 V et 24 V.

Fonctions: stop / position / clignotant / éclairage de plaque

Distance maximale de transmission 20 mètres



rif.	cod.
1 Kit	2050892



1964
2024
60
ANNIVERSARY



MANUTENZIONE DEL VERDE
GREEN SPACE MAINTENANCE
PFLEGE DER GRÜNFLÄCHEN
MANTENIMIENTO DE ÁREAS VERDES
ENTRETIEN DES ESPACES VERTS

Impiego	Use	Verwendung	Uso	Utilisation
---------	-----	------------	-----	-------------

Robot tagliaerba radiocomandato che permette di curare la vegetazione in luoghi pericolosi, scomodi e difficilmente accessibili.

Remote controlled robot mower that allows you to maintain vegetation in dangerous, awkward and hard-to-reach places.

Funkgesteuerter Rasenmäherroboter, mit dem Sie die Vegetation an gefährlichen, unbequemen und schwer zugänglichen Stellen pflegen können.

Robot cortacésped radiocomandado que le permite cuidar la vegetación en lugares peligrosos, incómodos y de difícil acceso.

La tondeuse radiocommandé est un robot qui permet d'entretenir la végétation dans des endroits dangereux, inconfortables et difficiles d'accès.



Radiocomando (di serie)
Remote control (standard)
Funksteuerung (serienmässig)
Radiomando (estándar)
Radiocommande (de série)

MOD



mod.

cod.

ROBY-PRO 550

1003317

ROBY-PRO 550

Funzioni del radiocomando	Radio control functions	Funksteuerungsfunktionen	Funciones de radiomando	Fonctions de radiocommande
---------------------------	-------------------------	--------------------------	-------------------------	----------------------------

Il radiocomando permette all'operatore di rimanere a distanza di sicurezza durante il lavoro e gestisce:

- regolazione dell'altezza di taglio
- velocità di avanzamento
- joystick multidirezionale (destra, sinistra e giro di 360°)
- guida in avanti e retromarcia
- accensione/spegnimento motore a scoppio
- accelerazione/decelerazione lame e motore
- pulsante a fungo di emergenza

The remote control allows the operator to remain at a safe distance while working and manages:

- cutting height adjustment
- forward speed
- multidirectional joystick (right, left and 360° rotation)
- forward and reverse driving
- turning on/off combustion engine
- blade and engine acceleration/deceleration
- emergency button

Die Funksteuerung ermöglicht es dem Bediener, während der Arbeit einen sicheren Abstand einzuhalten und verwaltet:

- Schnitthöhenverstellung
- Fahrgeschwindigkeit
- multidirektionaler Joystick (rechts, links und 360°-Drehung)
- vorwärts und rückwärts fahren
- Verbrennungsmotor ein/aus
- Beschleunigung/Verzögerung von Messern und Motor
- Notfalltaste

El radiomando permite al operador permanecer a una distancia de seguridad durante el trabajo y gestiona:

- ajuste de la altura de corte
- velocidad de avance
- joystick multidireccional (derecha, izquierda y giro de 360°)
- marcha adelante y marcha atrás
- activación/desactivación del motor de combustión
- aceleración/desaceleración de las cuchillas y del motor
- botón de emergencia

La radiocommande permet à l'opérateur de rester à une distance de sécurité pendant le travail. De plus, elle gère :

- le réglage de la hauteur de coupe
- la vitesse d'avancement
- le joystick multidirectionnel (droite, gauche et rotation 360°)
- la direction avant et arrière
- la marche/arrêt du moteur à combustion
- l'accélération/décélération des lames et du moteur
- le bouton d'arrêt d'urgence

Dati tecnici	Technical data	Technische Daten	Datos técnicos	Données techniques	ROBY-PRO 550
Dimensioni	Dimensions	Abmessungen	Dimensiones	Dimensions	95×140×60 cm
Larghezza di taglio	Cutting width	Schnittbreite	Anchura de corte	Largeur de coupe	550 mm
Altezza di taglio min/max	Min/max cutting height	Min/max Schnitthöhe	Altura de corte min./máx.	Hauteur de coupe min/max	20 - 150 mm
Lame flottanti con doppia affilatura	Floating blades with double sharpening	Schwimmende Messer mit Doppelschleifung	Cuchillas flotantes con afilado doble	Lames flottantes à double affûtage	✓
Tipo di motore	Motor type	Motor-Typ	Tipo de motor	Type de moteur	Petrol engine 7,5 HP - 224 cc
Batteria	Battery	Batterie	Batería	Batterie	1×12V 12Ah
Velocità	Speed	Geschwindigkeit	Velocidad	Vitesse de rotation	0-3 km/h
Peso	Weight	Gewicht	Peso	Poids	153 kg
Pendenza di lavoro	Working slope	Arbeitsneigung	Pendiente de trabajo	Pente de travail	max 25° (45%)
Larghezza-Spessore cingoli	Track width-Thickness	Spurbreite-Dicke	Ancho-Grosor de pistas	Largeur de la chenille - Epaisseur	15×3 cm
Luci frontali LED	LED front lights	LED-Frontleuchten	Luces LED delanteras	Feux avant LED	✓

ROBY-PRO

REMOTE CONTROLLED LAWN MOWER

ROBY-PRO

FUNKGESTEUERTER RASENMÄHER

ROBY-PRO

CORTACÉSPED RADIOCONTROLADO

ROBY-PRO

TONDEUSE RADIOCOMMANDÉE



ORIGINAL MADE IN ITALY



Radiocomando (di serie)
Remote control (standard)
Funksteuerung (serienmäßig)
Radiomando (estándar)
Radiocommande (de série)



SCAN ME!



mod.

cod.

ROBY-PRO 800

1003318

ROBY-PRO 800

Vantaggi	Advantages	Vorteile	Ventajas	Avantages
<ul style="list-style-type: none"> • Semplice da manovrare, affidabile e particolarmente efficiente • Trazione cingolata e stabilità su qualsiasi tipo di terreno, anche sassoso • Pendenza lavoro in salita 40°, laterale e in discesa 30° • Lame flottanti e pivotanti che tagliano in entrambe le direzioni, anche in retromarcia • Sistema di protezione lame con catene • Sistema ibrido avanzamento elettrico e taglio tramite motore a scoppio che ricarica le batterie per avanzamento • Velocità regolabile • Movimento anche da spento con motori elettrici • Set di profili di protezione anteriore e posteriore per evitare ribaltamenti e urti 	<ul style="list-style-type: none"> • Easy to manoeuvre, reliable and particularly efficient. • Track traction and stability on all types of terrain, even stony ones • Working slope uphill 40°, side and downhill 30° • Floating and pivoting blades that cut in both directions, even in reverse • Blade protection system with chains • Electrical advance and cutting hybrid system by means of a petrol engine that recharges the batteries for advancement • Adjustable speed • Motion even when switched off with electric motors • Front and rear protective bumpers to prevent tipping and bumping 	<ul style="list-style-type: none"> • Einfach zu manövrieren, zuverlässig und besonders effizient • Raupentraction und Stabilität auf jedem Gelände, auch auf steinigem Gelände • Arbeitsneigung bergauf 40°, seitlich und bergab 30° • Schwimmende und schwenkbare Messer, die in beide Richtungen schneiden, sogar rückwärts • Hybridsystem für elektrisches Fahren und Schnitt mittels Verbrennungsmotor, der die Batterien für das Fahren auflädt • Einstellbare Geschwindigkeit • Bewegung auch im ausgeschalteten Zustand mit Elektromotoren • Schutzstoßstangen vorne und hinten, die ein Umkippen und Stöße verhindern 	<ul style="list-style-type: none"> • Fácil de maniobrar, fiable y especialmente eficaz. • Tracción sobre orugas y estabilidad en todo tipo de terrenos, incluso pedregosos • Inclinación de trabajo cuesta arriba 40°, lateral y cuesta abajo 30° • Cuchillas flotantes y pivotantes que cortan en ambas direcciones, incluso marcha atrás • Sistema híbrido: avance eléctrico y corte mediante un motor de combustión interna que recarga las baterías para el avance • Velocidad regulable • Movimiento incluso apagado con motores eléctricos • Parachoques protector delantero y trasero para evitar vuelcos y golpes 	<ul style="list-style-type: none"> • Facile à manoeuvrer, fiable et particulièrement efficace • Traction sur chenilles et stabilité sur tout type de terrain, même pierreux • Pente de travail en montée 40°, latérale et en descente 30° • Lames flottantes et pivotantes qui coupent dans les deux sens, même en marche arrière • Système hybride d'avancement électrique et de coupe au moyen d'un moteur thermique qui recharge les batteries pour l'avancement • Vitesse réglable • Mouvement même à l'arrêt avec des moteurs électriques • Pare-chocs de protection avant et arrière qui empêchent le renversement et les chocs

ROBY-PRO 800

Dati tecnici	Technical data	Technische Daten	Datos técnicos	Données techniques	ROBY-PRO 800
Dimensioni	Dimensions	Abmessungen	Dimensiones	Dimensions	120×113×65 cm
Larghezza di taglio	Cutting width	Schnittbreite	Anchura de corte	Largeur de coupe	800 mm
Altezza di taglio min/max	Min/max cutting height	Min/max Schnitthöhe	Altura de corte min./máx.	Hauteur de coupe min/max	20 - 150 mm
Lame flottanti con doppia affilatura	Floating blades with double sharpening	Schwimmende Messer mit Doppelschleifung	Cuchillas flotantes con afilado doble	Lames flottantes à double affûtage	✓
Tipo di motore	Motor type	Motor-Typ	Tipo de motor	Type de moteur	Petrol engine 12,5 HP - 452 cc
Batteria	Battery	Batterie	Batería	Batterie	2× 12V 20Ah
Velocità	Speed	Geschwindigkeit	Velocidad	Vitesse de rotation	0-5,5 km/h
Peso	Weight	Gewicht	Peso	Poids	277 kg
Pendenza di lavoro	Working slope	Arbeitsneigung	Pendiente de trabajo	Pente de travail	max 30° (55%)
Larghezza-Spessore cingoli	Track width-Thickness	Spurbreite-Dicke	Ancho-Grosor de pistas	Largeur de la chenille - Epaisseur	15×3 cm
Luci frontali LED	LED front lights	LED-Frontleuchten	Luces LED delanteras	Feux avant LED	✓

Impiego	Use	Verwendung	Uso	Utilisation
---------	-----	------------	-----	-------------

La rasaerba bilama ZRA è una macchina professionale pensata per la cura e manutenzione del manto erboso in parchi e giardini.

The ZRA is a professional mower for the care and maintenance of lawns in parks and gardens.

Der Rasenmäher Doppel-Schneide ZRA ist für den professionellen Gebrauch bestimmt und dient zur Pflege und Instandhaltung von Rasen in Parkanlagen und Gärten.

La segadora de césped ZRA es una máquina profesional específica para el cuidado y mantenimiento del césped en parques y jardines.

La tondeuse à deux lames ZRA est une machine professionnelle conçue pour l'entretien du gazon dans les parcs et les jardins.



ZRA BILAMA

mod.	cod. dx	cod. sx	cm	HP	nr	cm	kg
ZRA 800	1002032	1002034	82	10 - 14	4	84×100×35	83
ZRA 1000	1002033	1002035	102	12 - 18	4	104×100×35	98

Versione anteriore - Front version - Front-Version - Versión frontal - Version avant

mod.	cod. dx	cod. sx	cm	HP	nr	cm	kg
ZRA 800	1002038	1002040	82	10 - 14	4	84×100×35	83
ZRA 1000	1002039	1002041	102	12 - 18	4	104×100×35	98

Versione posteriore - Rear version - Hintere-Version - Versión trasera - Version arrière

Di serie	Standard equipment	Serienmässig	Estándar	De série
<ul style="list-style-type: none"> Ruote girevoli e regolabili in altezza Trasmissione in acciaio temperato a bagno d'olio con disinnesto a ruota libera e chiavetta di sicurezza Attacco completo al motocultivatore snodabile e regolabile Utensile da taglio intercambiabile in acciaio temperato Protezioni antinfortunistiche conformi alla normativa CE 	<ul style="list-style-type: none"> Height-adjustable castoring wheels with pneumatic tyres Oil bath gearbox in tempered steel with freewheel and safety key Complete, adjustable, pivoting cultivator attachment Interchangeable tempered steel cutter Protective equipment as per EC safety rules 	<ul style="list-style-type: none"> Höheneinstellbare Führungsschwenkräder Ölbadgetriebe aus gehärtetem Stahl mit Freilauf und Sicherheitsschlüssel Anschluss für Einachser artikuliert und verstellbar Austauschbares Schneidwerkzeug aus gehärtetem Stahl Unfallschutz nach EU-Vorschriften 	<ul style="list-style-type: none"> Ruedas neumáticas giratorias de altura regulable Transmisión de acero templado en baño de aceite con desacoplamiento de rueda libre mediante chaveta de seguridad Acoplamiento completo al motocultivador, articulado y regulable Accesorio de corte intercambiabile de acero templado Protecciones de seguridad de acuerdo con la norma CE 	<ul style="list-style-type: none"> Roues pneumatiques pivotantes et réglables en hauteur Transmission en acier trempé à bain d'huile avec débrayage à roue libre et goupille de sécurité Attelage complet au motoculteur articulé et réglable Outil de coupe interchangeable en acier trempé Protections contre les accidents aux normes CE

ZRA	DOUBLE-BLADE LAWN MOWER
ZRA	RASENMÄHER DOPPEL-SCHNEIDE
ZRA	SEGADORA DE CÉSPED DOBLE-CUCHILLA
ZRA	TONDEUSE À DEUX LAMES



ORIGINAL MADE IN ITALY

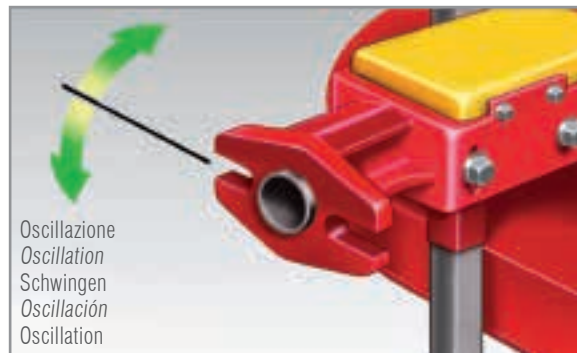
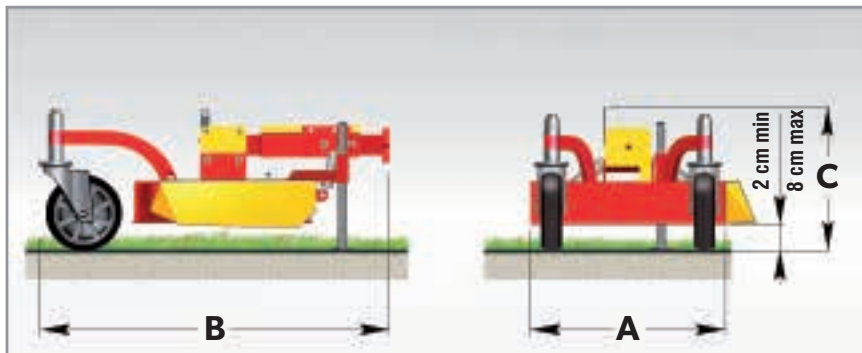

ZRA BILAMA

*Specificare il tipo di motocoltivatore a cui applicare la rasaerba e la rotazione della presa di forza (PDF).
 Always specify the model of cultivator to which the mower will be attached, and the direction of the PTO rotation.
 Bitte den Typ des Einachsschleppers, an den der Rasenmäher angebaut werden soll, und die Zapfwelldrehung angeben.
 Especificar el tipo de motocultivador al que se debe aplicar la segadora de césped y la rotación de la toma de fuerza (TDF).
 Préciser le type de motoculteur auquel sera appliquée la tondeuse ainsi que la rotation de la (PDF).*

cod.	Ricambi	Spare parts	Ersatzteile	Recambios	Pièces de rechange
5130001	Giunto cardanico	Joint	Gelenkwelle	Arbol de cardan	Accouplement à cardan
5350010	Lama terminale mod. 800 dx	Terminal blade mod. 800 rh	Endschneide mod. 800 Recht	Cuchilla terminal mod. 800 dcha	Lames terminales mod. 800 droite
5350011	Lama terminale mod. 800 sx	Terminal blade mod. 800 lf	Endschneide mod. 800 Links	Cuchilla terminal mod. 800 izq.	Lames term. mod. 800 gauche
5350014	Lama terminale mod. 1000 dx	Terminal blade mod. 1000 rh	Endschneide mod. 1000 Recht	Cuchilla terminal mod. 1000 dcha	Lames term. mod. 1000 droite
5350013	Lama terminale mod. 1000 sx	Terminal blade mod. 1000 lf	Endschneide mod. 1000 Links	Cuchilla terminal mod. 1000 izq.	Lames term. mod. 1000 gauche
2350045	Lama completa mod. 800 dx	Complete blade mod. 800 rh	Kompletter Messersatz mod. 800 R	Cuchilla completa mod. 800 dcha	Lame complète mod. 800 droite
2350046	Lama completa mod. 800 sx	Complete blade mod. 800 lf	Kompletter Messersatz mod. 800 L	Cuchilla completa mod. 800 izq.	Lame comp. mod. 800 gauche
2350043	Lama completa mod. 1000 dx	Complete blade mod. 1000 rh	Kompletter Messersatz mod. 1000 R	Cuchilla completa mod. 1000 dcha	Lame comp. mod. 1000 droite
2350044	Lama completa mod. 1000 sx	Complete blade mod. 1000 lf	Kompletter Messersatz mod. 1000 L	Cuchilla completa mod. 1000 izq.	Lame com. mod. 1000 gauche
5411002	Ruota pneumatica	Tire wheel	Reifen	Rueda neumatica	Roue pneumatique
(**)	Albero innesto P.D.F.	P.T.O. Shaft coupling	Kupplungswelle	Árbol acoplamiento T.D.F.	Abre d'enclenchement P.D.F.
(***)	Attacco P.D.F.	P.T.O. Attachment	Anschluss	Acoplamiento T.D.F. en fundición	Attelage de P.D.F. en fonte

(*) (**) codici variabili a seconda del modello | varying codes according to the model | Unterschiedliche Codes je nach Modell | códigos variables según el modelo | codes variables d'après le modèle

Impiego **Use** **Verwendung** **Uso** **Utilisation**

La distruggierba FALK, disponibile nelle versioni mono-disco e bi-disco, è interamente in acciaio ed è adattabile a tutti i tipi di motocoltivatore. È ideale per la manutenzione del terreno in piantagioni eseguite a file.

The all-steel FALK shredder comes in single and double disk versions and adapts easily to all models of cultivator. The FALK shredder is ideal for ground maintenance work between row crops.

Der als Ein- und Zweischeiben-Gerät erhältliche Grashäcksler FALK ist vollständig aus Stahl gebaut und lässt sich an jeden Einachsertyp anpassen. Er ist ideal für die Instandhaltung des Bodens in Pflanzungen mit Reihenanbau.

La trituradora de hierba FALK, disponible en las versiones con uno o dos discos, es completamente de acero y puede adaptarse a todos los motocoltivadores. Es ideal para el mantenimiento del terreno en plantaciones en línea.

Le girobroyeur FALK, disponible dans les versions à un ou deux disques, est entièrement en acier et est adaptable à tous les types de motoculteurs. Il est particulièrement indiqué pour l'entretien du sol dans les plantations en rangées.



FALK 6/7 Monolama
FALK 6/7 Single-blade
FALK 6/7 Einzel-Schneide
FALK 6/7 Mono hélice
FALK 6/7 Lame-unique

FALK 8 Bilama
FALK 8 Double-blade
FALK 8 Doppel-Schneide
FALK 8 Bi hélice
FALK 8 Deux lames



mod.	cod.	cm	HP	nr	cm	kg
FALK 6	1002125	60	8 - 10	2	68×90×38	50
FALK 7	1002126	70	8 - 12	2	78×95×38	60
FALK 8	1002127	80	8 - 12	6	88×100×38	80

Di serie	Standard equipment	Serienmässig	Estándar	De série
<ul style="list-style-type: none"> Disponibile in diverse versioni di potenza, diametro di taglio, numero di lame, peso e dimensioni Trasmissione in acciaio temperato a bagno d'olio con disinnesto a ruota libera e chiavetta di sicurezza Attacco completo al motocoltivatore snodabile e registrabile Utensile da taglio intercambiabile in acciaio temperato Protezioni antinfortunistiche conformi alla normativa CE 	<ul style="list-style-type: none"> The FALK comes in a number of versions that differ in power, mowing diameter, the number of blades, size and weight Oil bath gearbox in tempered steel with freewheel and safety key Complete, adjustable, pivoting cultivator attachment Interchangeable tempered steel cutter Protective equipment as per EC safety rules 	<ul style="list-style-type: none"> Die verschiedenen Ausführungen unterscheiden sich in Leistung, Schneiddurchmesser, Anzahl der Schneiden, Gewicht und Abmessungen Getriebe aus gehärtetem Stahl mit Freilauf-Auskupplung und Sicherheitsschlüssel Kompletter, verstellbarer Gelenkanschluss für den Anbau am Einachsschlepper Auswechselbares Schneidwerkzeug aus gehärtetem Stahl Unfallschutz nach EU-Vorschriften 	<ul style="list-style-type: none"> Está disponible con diferentes versiones de potencia, diámetro de corte, peso y medidas Transmisión de acero templado en baño de aceite con desacoplamiento de rueda libre mediante chaveta de seguridad Acoplamiento completo al motocultivador, articulado y regulable Accesorio de corte intercambiabile de acero templado Protecciones de seguridad de acuerdo con la norma CE 	<ul style="list-style-type: none"> Il est disponible en plusieurs versions de puissance, diamètre de coupe, nombre de lames, poids et dimensions Transmission en acier trempé à bain d'huile avec débrayage à roue libre et goupille de sécurité Attelage complet au motoculteur articulé et réglable Outil de coupe interchangeable en acier trempé Protections contre les accidents aux normes CE

FALK	SHREDDER
FALK	GRASZERKLEINER
FALK	TRITURADORA DE HIERBA
FALK	GIROBROYEUR POUR MTC



ORIGINAL MADE IN ITALY

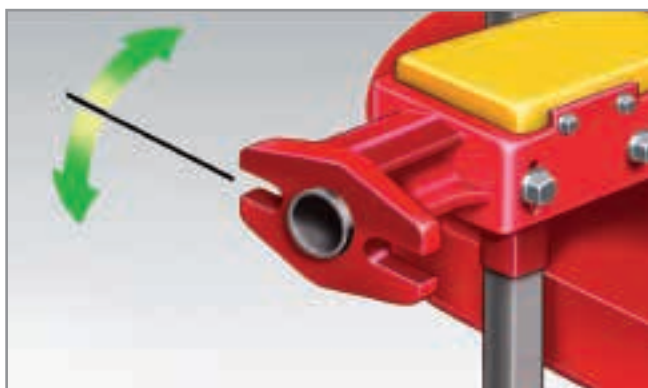
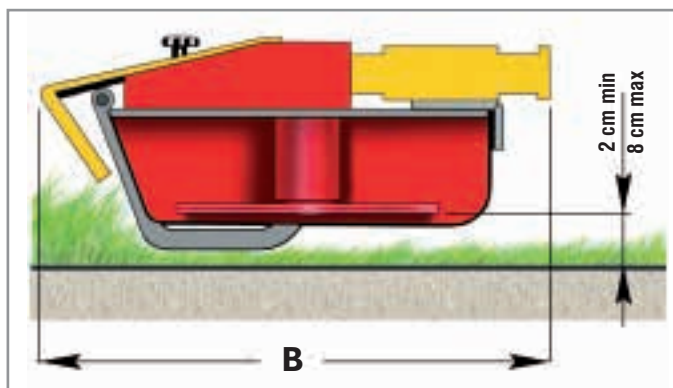

Oscillazione
Oscillation
Schwingen
Oscilación
Oscillation

FALK 6/7 Monolama
FALK 6/7 Single-blade
FALK 6/7 Einzel-Schneide
FALK 6/7 Mono hélice
FALK 6/7 Lame-unique

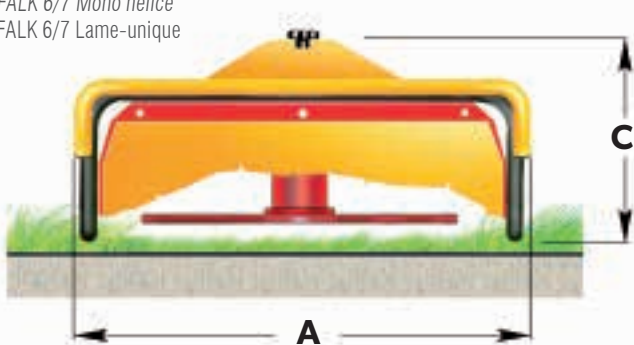

FALK 8 Bilama
FALK 8 Double-blade
FALK 8 Doppel-Schneide
FALK 8 Bi hélice
FALK 8 Deux lames

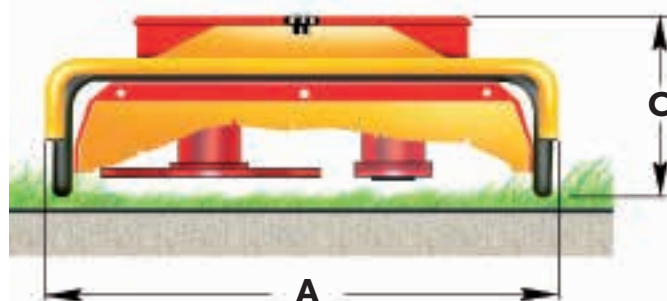

FALK



Specificare sempre il tipo di motocoltivatore a cui applicare la distruggierba.

Always specify the model of cultivator to which the shredder will be attached.

Bitte immer den Typ des Einachsschleppers, an den der Grashäcksler angebaut werden soll, angeben.

Especificar siempre el tipo de motocultivador al que se acoplará la trituradora.

Toujours préciser le type de motoculteur auquel sera appliqué le girobroyeur.

cod.	Ricambi	Spare parts	Ersatzteile	Recambios	Pièces de rechange
5130001	Giunto cardanico	Joint	Gelenkwelle	Arbol de cardan	Accouplement à cardan
5400024	Protezione gomma FALK 6	Rubber protection FALK 6	Schutzgummi FALK 6	Protección de caucho FALK 6	Prot. en caoutchouc FALK 6
5400025	Protezione gomma FALK 7	Rubber protection FALK 7	Schutzgummi FALK 7	Protección de caucho FALK 7	Prot. en caoutchouc FALK 7
5400053	Protezione gomma FALK 8	Rubber protection FALK 8	Schutzgummi FALK 8	Protección de caucho FALK 8	Prot. en caoutchouc FALK 8
3230319	Disco portalama FALK 6	Blade-holder disk FALK 6	Schneidenscheibe FALK 6	Disco portacuchilla FALK 6	Disque porte-lame FALK 6
3230320	Disco portalama FALK 7	Blade-holder disk FALK 7	Schneidenscheibe FALK 7	Disco portacuchilla FALK 7	Disque porte-lame FALK 7
3230321	Disco portalama FALK 8	Blade-holder disk FALK 8	Schneidenscheibe FALK 8	Disco portacuchilla FALK 8	Disque porte-lame FALK 8
5350052	Lama terminale	Terminal blade	Endschneide	Cuchilla terminal	Lames terminales
2350072	Lama completa FALK 6	Complete blade FALK 6	Kompletter Messersatz FALK 6	Cuchilla completa FALK 6	Lame complète FALK 6
2350073	Lama completa FALK 7	Complete blade FALK 7	Kompletter Messersatz FALK 7	Cuchilla completa FALK 7	Lame complète FALK 7
2350074	Lama completa FALK 8	Complete blade FALK 8	Kompletter Messersatz FALK 8	Cuchilla completa FALK 8	Lame complète FALK 8
(*)	Albero innesto P.D.F.	P.T.O. Shaft coupling	Kupplungswelle	Árbol acoplamiento T.D.F.	Abre d'enclenchement P.D.F.
(**)	Attacco P.D.F.	P.T.O. Attachment	Anschluss	Acoplamiento T.D.F. en fundición	Attelage de P.D.F. en fonte

(*) (**) codici variabili a seconda del modello | varying codes according to the model | Unterschiedliche Codes je nach Modell | códigos variables según el modelo | codes variables d'après le modèle

Impiego	Use	Verwendung	Uso	Utilisation
---------	-----	------------	-----	-------------

L'arieggiatore AR è pensato per rimuovere muschio e feltro che si depositano sul manto erboso consentendo così un'adeguata ossigenazione ed una perfetta manutenzione del terreno.

The AR aerator is designed to remove the moss and thatch that choke grass, allowing the soil to breathe and support a lush lawn.

Der Vertikutierer AR dient zum Entfernen von Moos und Rasenfilz aus der Grasnarbe und sorgt so für die optimale Durchlüftung und perfekte Instandhaltung des Bodens.

El escarificador AR ha sido estudiado para eliminar el musgo y el fieltro que se deposita sobre el suelo, así permitiendo una adecuada oxigenación y un perfecto mantenimiento del suelo.

L'aérateur AR est conçu pour éliminer la mousse et le feutre qui s'accumulent à la surface permettant ainsi une oxygénation adéquate et un parfait entretien du sol.

AR ARIEGGIATORE



AR 60 S

AR 45 S

AR 45 S

AR 60 S

	L _{WA} 105 dB
	L _{WA} 113 dB

L'apparecchiatura è conforme ai requisiti richiesti dalla direttiva 2000/14/CE per la limitazione del rumore ambientale.
The equipment complies with the requirements of Directive 2000/14/EC for the limitation of environmental noise.

mod.	cod.	cm	HP	nr	cm	kg
AR 45 S Professional	1002106	41	5,5 HONDA GP 160	33	81×115×98	50
AR 60 S Professional	1002104	56	6,5 HONDA GP 200	42	94×115×98	60

La macchina ha peso e forme ridotte che ne facilitano l'utilizzo. Il motore varia dai 5,5 HP ai 6,5 HP a seconda del modello, garantendo al cliente elevate prestazioni. A richiesta è possibile applicare un pratico cesto per la raccolta del materiale di scarico. La Zanon offre 2 versioni di arieggiatore, l'AR 45 S e l'AR 60 S Professional, che si differenziano per capacità di lavoro, potenza del motore, numero di lame, peso e dimensioni. Protezioni antifortunistiche conformi alla normativa CE.

The AR is particularly easy to use thanks to its compact size and low weight. An engine power output of 5.5 HP or 6.5 HP, depending on model, ensures excellent performance. On request, the AR aerator can be fitted with a waste collection container. Zanon offers 2 versions of the AR aerator: the AR 45 S and the AR 60 S Professional. The two differ in working width, engine power, the number of blades, size and weight. Protective equipment as per EC safety rules.

Reduziertes Gewicht und kompakte Formen erleichtern seinen Gebrauch. Der je nach Modell 5,5 bis 6,5 HP starke Motor garantiert hohe Leistungen. Auf Anfrage kann ein praktischer Auffangkorb für das Vertikutiergut angebracht werden. Zanon bietet 2 Ausführungen des Vertikutierers, nämlich AR 45 S und AR 60 S Professional, die sich durch Arbeitskraft, Motorleistung, Anzahl der Schneiden, Gewicht und Abmessungen unterscheiden. Unfallschutz nach EU-Vorschriften.

El peso reducido y el tamaño compacto de la máquina facilitan su empleo. El motor tiene una potencia entre 5,5 HP y 6,5 HP según el modelo, y garantiza altas prestaciones al cliente. A petición es posible aplicar una cómoda cesta de recogida del material residual. Zanon ofrece 2 versiones de escarificador, el AR 45 S y el AR 60 S Professional, que se distinguen por la capacidad de trabajo, potencia del motor, número de cuchillas, peso y medidas. Protecciones de seguridad de acuerdo con la norma CE.

La machine a un poids et une forme ergonomique qui en facilitent l'utilisation. La puissance du moteur varie de 5,5 HP à 6,5 HP suivant le modèle, en garantissant au client de hautes performances. Sur demande, on peut y appliquer un panier pour la récupération des déchets végétaux. Zanon propose 2 versions d'aérateur, l'AR 45 S et l'AR 60 S Professional, qui se différencient par la capacité de travail, la puissance du moteur, le nombre de lames, le poids et les dimensions. Protections contre les accidents aux normes CE.

AR	AERATOR
AR	VERTIKUTIERER
AR	ESCARIFICADOR
AR	AÉRATEUR



➔ **Standard equipment**

Coltelli mobili
Movable blades
Bewegliche Messer
Couteaux mobiles
Cuchillas móviles

⌚ **Standard equipment**

Particolare tendicinghia
Particular belt
Keilriemenspanner
Correa
Courroie



On request
Cesto per la raccolta
Collection basket
Fangkorb komplett
Cesta de recogida
Panier de récupération

AR ARIEGGIATORE

cod.	A richiesta	On request	Auf Anfrage	Opcionales	Sur demande
2050039	Cesto per la raccolta AR 45	Collection basket AR 45	Fangkorb komplett AR 45	Cesta de recogida AR 45	Panier de récupération AR 45
2050040	Cesto per la raccolta AR 60	Collection basket AR 60	Fangkorb komplett AR 60	Cesta de recogida AR 60	Panier de récupération AR 60

cod.	Ricambi	Spare parts	Ersatzteile	Recambios	Pièces de rechange
5411005	Ruote	Wheels	Rad	Ruedas	Roue
5215033	Barra portacoltelli AR 45	Knife-holder bar AR 45	Schneidenhalterung AR 45	Barra de corte AR 45	Barre porte-couteau AR 45
5215032	Barra portacoltelli AR 60	Knife-holder bar AR 60	Schneidenhalterung AR 60	Barra de corte AR 60	Barre porte-couteau AR 60
3230130	Albero portacoltelli AR 45	Knife-holder shaft AR 45	Welle Schneidenhalterung AR 45	Portacuchilla AR 45	Arbre porte-couteau AR 45
3230129	Albero portacoltelli AR 60	Knife-holder shaft AR 60	Welle Schneidenhalterung AR 60	Portacuchilla AR 60	Arbre porte-couteau AR 60
5350037	Coltello	Knife	Schneide	Cuchilla	Couteau
5354002	Cinghia SPZX 800	Belt SPZX 800	Riemen SPZX 800	Correa SPZX 800	Courroie SPZX 800
5352007	Telo cesta raccolta AR 45	Collection basket AR 45	Fangkorb AR 45	Tela de colector AR 45	Bâche panier de récup. AR 45
5352008	Telo cesta raccolta AR 60	Collection basket AR 60	Fangkorb AR 60	Tela de colector AR 60	Bâche panier de récup. AR 60
5023112	Motore honda HP 5,5 AR 45	Honda 5,5 HP motor AR 45	Honda-Motor HP 5,5 AR 45	Motor honda HP 5,5 AR 45	Moteur honda HP 5,5 AR 45
5023113	Motore honda HP 6,5 AR 60	Honda 6,5 HP motor AR 60	Honda-Motor HP 6,5 AR 60	Motor honda HP 6,5 AR 60	Moteur honda HP 6,5 AR 60

Impiego	Use	Verwendung	Uso	Utilisation
---------	-----	------------	-----	-------------

La falciatrice rotante ZRF è un prodotto utile per tagliare l'erba destinata a consumo animale. Grazie alla sua altezza consente un taglio netto dalla radice mantenendo integro il fusto di erba e ramaglie.

The ZRF rotary mower represents the ideal way of cutting grass for animal fodder. Its height allows grass and plants to be cut cleanly above the roots, leaving stems and leaves intact.

Das Kreiselmäherwerk ZRF ist ein nützliches Gerät zum Mähen von Gras zur Futtergewinnung. Dank seiner Höhe gestattet einen sauberen Schnitt der Wurzel, während Grasstängel und Niederholz intakt bleiben.

La segadora rotativa ZRF es útil para cortar hierba destinada a alimentación de animales. Por su altura, permite un corte neto desde la raíz manteniendo íntegro el tallo de la hierba y ramas.

La rotofaucheuse ZRF est un produit utile pour couper l'herbe destinée à la consommation animale. Grâce à sa hauteur, elle permet une coupe nette à la racine tout en maintenant intacte la tige d'herbe et les branches.



mod.	cod.	cm	HP	nr	cm	kg
ZRF 700	1002001	72	8 - 10	4	114×95×35	70
ZRF 800	1002002	82	10 - 14	6	123×97×35	83

Versione bassa - Low version - Niedrige Version - Versión baja - Version basse

mod.	cod.	cm	HP	nr	cm	kg
ZRF 700	1002006	72	8 - 10	4	114×95×43	72
ZRF 800	1002007	82	10 - 14	6	123×97×43	85
ZRF 1000	1002008	102	14 - 18	6	144×102×43	98
ZRF 1150	1002009	117	18 - 22	8	158×106×43	110

Versione alta - High version - Hohe Version - Versión alta - Version haute

Di serie	Standard equipment	Serienmässig	Estándar	De série
<ul style="list-style-type: none"> Scatola ingranaggi a bagno d'olio Attacco completo al motocultivatore snodabile e registrabile Protezioni antinfortunistiche conformi alla normativa CE 	<ul style="list-style-type: none"> Oil bath gearbox Complete, adjustable, pivoting cultivator attachment Protective equipment as per EC safety rules 	<ul style="list-style-type: none"> Getriebegehäuse im Ölbad Kompletter, verstellbarer Gelenkanschluss für den Anbau am Einachsschlepper Unfallschutz nach EU-Vorschriften 	<ul style="list-style-type: none"> Caja de engranajes en baño de aceite Acoplamiento completo al motocultivador, articulado y regulable Protecciones de seguridad de acuerdo con la norma CE 	<ul style="list-style-type: none"> Boîte à engrenages à bain d'huile Attelage complet au motoculteur articulé et réglable Protections contre les accidents aux normes CE

ZRF	DRUM MOWER
ZRF	TROMMELMÄHWERK FÜR EINACHSER
ZRF	SEGADORA ROTATIVA
ZRF	ROTOFAUCHEUSE



È dotata di un doppio disco di lame ed è completa di tela di protezione, scatola ingranaggi a bagno d'olio e attacco completo al motocoltivatore snodabile e registrabile. È disponibile in vari modelli, a seconda delle esigenze di lavoro e della potenza del motocoltivatore a cui va applicata.

The mower is fitted with double disk cutters and comes complete with a fabric safety cover, oil bath gearbox and complete, adjustable, pivoting cultivator attachment. The ZRF comes in various versions, to suit different mowing requirements and cultivator power outputs.

Der Kreiselmäher ist mit doppelter Schneidscheibe ausgestattet, sowie mit Schutzplane, Getriebegehäuse im Ölbad und kompletter und verstellbarer Gelenkanschluss für den Anbau am Einachsschlepper. Je nach Einsatzanforderungen und Leistung des Einachsschlepper, an den er angebaut wird, ist er in verschiedenen Modellen erhältlich.

Monta un doble disco de cuchillas y bastidor de protección, caja de engranajes en baño de aceite y acoplamiento completo al motocultivador, articulado y regulable. Esta disponible en varios modelos, según las necesidades de trabajo y la potencia del motocultivador al que se acopla.

Elle est équipée d'un double disque de lames et est fournie avec bâche de protection, boîte à engrenages à bain d'huile et attelage complet au motoculteur articulé et réglable. Elle est disponible en plusieurs modèles, suivant les exigences de travail et la puissance du motoculteur auquel elle doit être appliquée.

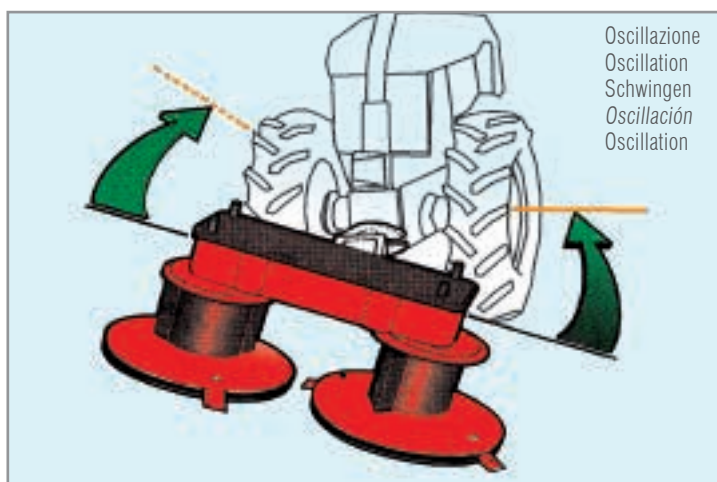

Oscillazione
Oscillation
Schwingen
Oscillación
Oscillation

ZRF FALCIATRICE

Specificare sempre il tipo di ruote che monta il motocoltivatore a cui applicare la falciatrice rotante.
Always specify the type of wheels on the cultivator to which the rotary mower will be attached.
Bitte immer den Rädertyp angeben, der an dem Einachsschlepper, an den das Kreiselmäherwerk angebaut werden soll, montiert sind
Especificar siempre el tipo de ruedas que monta el motocultivador al que se enganchará la segadora rotativa.
un produit Toujours préciser le type de roues équipant le motoculteur auquel sera appliquée la rototafcheuse.

cod.	Ricambi	Spare parts	Ersatzteile	Recambios	Pièces de rechange
5130001	Giunto cardanico	Joint	Gelenkwelle	Arbol de cardan	Accouplement à cardan
5350001	Coltello	Knife	Schneide	Cuchilla	Couteau
5400001	Prot. gomma ZRF 700 v. bassa	Rubber prot. ZRF 700 low	Schutzgummi ZRF 700 niedrig	Prot. de caucho ZRF 700 baja	Prot. en caout. ZRF 700 basse
5400003	Prot. gomma ZRF 800 v. bassa	Rubber prot. ZRF 800 low	Schutzgummi ZRF 800 niedrig	Prot. de caucho ZRF 800 baja	Prot. en caout. ZRF 800 basse
5400002	Prot. gomma ZRF 700 v. alta	Rubber prot. ZRF 700 high	Schutzgummi ZRF 700 hoch	Prot. de caucho ZRF 700 alta	Prot. en caout. ZRF 700 haute
5400004	Prot. gomma ZRF 800 v. alta	Rubber prot. ZRF 800 high	Schutzgummi ZRF 800 hoch	Prot.n de caucho ZRF 800 alta	Prot. en caout. ZRF 800 haute
5400006	Protezione gomma ZRF 1000	Rubber protection ZRF 1000	Schutzgummi ZRF 1000	Protección de caucho ZRF 1000	Prot. en caoutchouc ZRF 1000
5400008	Protezione gomma ZRF 1150	Rubber protection ZRF 1150	Schutzgummi ZRF 1150	Protección de caucho ZRF 1150	Prot. en caoutchouc ZRF 1150
(*)	Albero innesto P.D.F.	P.T.O. Shaft coupling	Kupplungswelle	Árbol acoplamiento T.D.F.	Abre d'enclenchement P.D.F.
(**)	Attacco P.D.F.	P.T.O. Attachment	Anschluss	Acoplamiento T.D.F. en fundición	Attelage de P.D.F. en fonte

(*) (**) codici variabili a seconda del modello | varying codes according to the model | Unterschiedliche Codes je nach modell | códigos variables según el modelo | codes variables d'après le modèle

Impiego	Use	Verwendung	Uso	Utilisation
---------	-----	------------	-----	-------------

La falciatrice rotante ZRF-T è un prodotto utile per tagliare l'erba destinata a consumo animale. Grazie alla sua altezza consente un taglio netto dalla radice mantenendo integro il fusto di erba e ramaglie.

The ZRF-T rotary mower represents the ideal way of cutting grass for animal fodder. Its height allows grass and plants to be cut cleanly above the roots, leaving stems and leaves intact.

Das Kreiselmäherwerk ZRF-T ist ein nützliches Gerät zum Mähen von Gras zur Futtergewinnung. Dank seiner Höhe gestattet einen sauberen Schnitt der Wurzel, während Grasstängel und Niederholz intakt bleiben.

La segadora rotativa ZRF-T es útil para cortar hierba destinada a alimentación de animales. Por su altura, permite un corte neto desde la raíz manteniendo integro el tallo de la hierba y ramas.

La rotofaucheuse ZRF-T est un produit utile pour couper l'herbe destinée à la consommation animale. Grâce à sa hauteur, elle permet une coupe nette à la racine tout en maintenant intacte la tige d'herbe et les branchages.



ZRF-T 1400

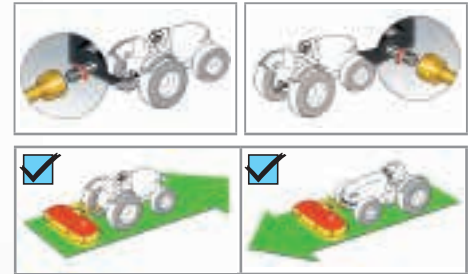

ZRF-T 1150

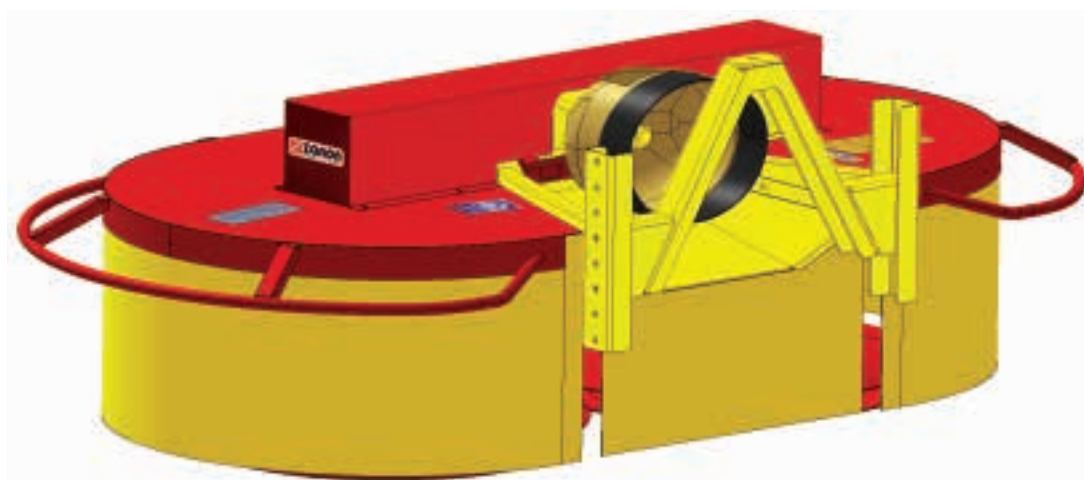
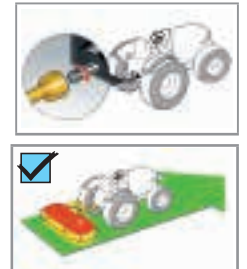

ZRF-T 1400



ZRF-T FALCIATRICE

ZRF-T	DRUM MOWER
ZRF-T	TROMMELMÄHWERK FÜR TRAKTOREN
ZRF-T	SEGADORA ROTATIVA
ZRF-T	ROTOFAUCHEUSE

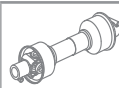

mod.	cod.	cm	HP	rpm/min	type	nr	cm	kg
ZRF-T 1150	1002005	115	10 - 40	540	T-30	8	158×106×80	120
ZRF-T 1400	1002447	140	20 - 40	540	T-40 RL*	8	180×115×78	170

Versione posteriore - Rear version - Hintere-Version - Versión trasera - Version arrière

mod.	cod.	cm	HP	rpm/min	type	nr	cm	kg
ZRF-T 1400	1003671	140	20 - 40	540	T-40 RL *	8	180×115×78	170
ZRF-T 1400	1002433	140	20 - 40	1000	T-40 RL *	8	180×115×78	170

Versione anteriore * Cardano con ruota libera | Front version * Joint free wheel clutch | Front-Version - Versión frontal * Cardán con rueda libre | Version avant * Cardan a roue libre

mod.	cod.	cm	HP	rpm/min	type	nr	cm	kg
ZRF-T 1400 CAT. 0	1003669	140	20 - 40	540/1000	T-40 RL *	8	180×115×78	170

Versione anteriore con attacco rapido cat. 0 * Cardano con ruota libera | Front version with cat. 0 quick coupling * Joint free wheel clutch
Front-Version mit Kuppeldreieck Kat. 0 * Gelenkwelle mit Freilauf | Versión frontal con acoplamiento rápido cat. 0 * Cardan a roue libre | Version avant avec attelage rapide cat. 0 * Cardan a roue libre

Di serie	Standard equipment	Serienmässig	Estándar	De série
<ul style="list-style-type: none"> Telaio con attacco ai tre punti del trattore Scatola di trasmissione con ruota libera Cardano Trasmissione secondaria mediante giunto cardanico Doppio disco di lame Tela di protezione Protezioni antinfortunistiche conformi alla normativa CE 	<ul style="list-style-type: none"> Frame with three point tractor hitch Oil bath gearbox with freewheel PTO drive shaft Universal joint secondary drive Double disk cutters Fabric safety cover Protective equipment as per EC safety rules 	<ul style="list-style-type: none"> Dreipunktbau des Traktors Getriebe Zahnräder im ölbad mit freilaufender Auskupplung Gelenkwelle Gelenkwelle mit Freilauf Doppelter Schneidscheibe ausgestattet Schutzplane Unfallschutz nach EU-Vorschriften 	<ul style="list-style-type: none"> Bastidor con enganche de tres puntos al tractor Caja de transmisión con rueda libre Cardán Transmisión secundaria con articulación de cardán Doble disco de cuchillas Lona de protección de tela Protecciones de seguridad de acuerdo con la norma CE 	<ul style="list-style-type: none"> Châssis avec attelage aux trois points du tracteur Boîtier de transmission avec roue libre Arbre cardan Transmission secondaire par joint de cardan Double disque de lames Bâche de protection Protections contre les accidents aux normes CE

cod.	Ricambi	Spare parts	Ersatzteile	Recambios	Pièces de rechange
5350001	Coltello ZRF-T	Knife ZRF-T	Schneide ZRF-T	Cuchilla ZRF-T	Couteau ZRF-T
5400008	Protezione gomma (mod.1150)	Rubber protection (mod.1150)	Schutzgummi (mod.1150)	Protección de caucho (mod.1150)	Protection en caoutchouc (mod.1150)
5400220	Protezione gomma (mod.1400)	Rubber protection (mod.1400)	Schutzgummi (mod.1400)	Protección de caucho (mod.1400)	Protection en caoutchouc (mod.1400)
5130027	Cardano T-30	Joint T-30	Gelenkwelle T-30	Cardan T-30	Cardan T-30
5130004	Cardano T-40 RL	Joint T-40 RL	Gelenkwelle T-40 RL	Cardan T-40 RL	Cardan T-40 RL
5130021	Cardano T-40 RL (sx)(mod.1400)	Joint T-40 RL (left)(mod.1400)	Gelenkwelle T-40 RL (Links)(mod.1400)	Cardan T-40 RL (Izq.)(mod.1400)	Cardan T-40 RL (Gauche)(mod.1400)
2020051	Scat. condotta (mod.1400)(540)*	Gearbox (mod.1400)(540)*	Getriebegehäuse (mod.1400)(540)*	Caia de engranajes (mod.1400)(540)*	Boîte d'engranages (mod.1400)(540)*
2020052	Scat. motrice (mod.1400)(540)*	Gearbox (mod.1400)(540)*	Getriebegehäuse (mod.1400)(540)*	Caja de transmisión (mod.1400)(540)*	Boîte de transmission (mod.1400)(540)*
2020053	Scatola motrice versione anteriore	Gearbox front version	Getriebegehäuse Front-Version	Caja de transmisión versión frontal	Boîte de tran. version avant

(* numero di giri al minuto PTO | number of revolutions per minute PTO | Anzahl der Umdrehungen pro Minute Zapfwelle | número de revoluciones por minuto TDF | nombre de tours par minute PDF



ZRF-T FALCIATRICE

Impiego **Use** **Verwendung** **Uso** **Utilisation**

La falciatrice rotante laterale ZRF-TL è un prodotto utile per tagliare l'erba destinata a consumo animale. Grazie alla sua altezza consente un taglio netto dalla radice mantenendo integro il fusto di erba e ramaglie.

The ZRF-TL side-mounted rotary mower represents the ideal way of cutting grass for animal fodder. Its height allows grass and plants to be cut cleanly above the roots, leaving stems and leaves intact.

Das Kreiselmäherwerk ZRF-TL für den seitlichen Anbau ist ein nützliches Gerät zum Mähen von Gras zur Futtergewinnung. Dank seiner Höhe gestattet einen sauberen Schnitt der Wurzel, während Grasstängel und Niederholz intakt bleiben.

La segadora rotativa lateral ZRF-TL es útil para cortar hierba destinada a alimentación de animales. Por su altura, permite un corte neto desde la raíz manteniendo integro el tallo de la hierba y ramas.

La rotofaucheuse latérale ZRF-TL est un produit utile pour couper l'herbe destinée à la consommation animale. Grâce à sa hauteur, elle permet une coupe nette à la racine tout en maintenant intacte la tige d'herbe et les branchages.



Di serie Standard Serienmässig Estándar De série

ZRF-TL FALCIATRICE











È dotata di un doppio disco di lame ed è completa di tela di protezione, trasmissione primaria ad ingranaggi a bagno d'olio, trasmissione secondaria mediante giunto cardanico e attacco ai tre punti del trattore. È disponibile in vari modelli, a seconda delle esigenze di lavoro e della potenza del trattore a cui va applicata.

The mower is fitted with double disk cutters and comes complete with a fabric safety cover, oil bath primary drive gearbox, universal joint secondary drive and a three point tractor hitch. The ZRF-TL comes in various versions, to suit different mowing requirements and tractor power outputs.

Der Kreiselmäher ist mit doppelter Schneidscheibe ausgestattet, sowie mit Schutzplane, Primärtrieb Zahnradgetriebe im Ölbad, Sekundärtrieb mittels Kardangelenken und Dreipunktanbau des Traktors. Je nach Einsatzanforderungen und Leistung des Traktors, an den er angebaut wird, ist er in verschiedenen Modellen erhältlich.

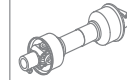
Monta un doble disco de cuchillas y bastidor de protección, transmisión primaria por engranajes en baño de aceite, transmisión secundaria mediante articulación de cardán y enganche de tres puntos al tractor. Esta disponible en varios modelos, según las necesidades de trabajo y la potencia del tractor al que se acopla.

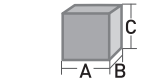
Elle est équipée d'un double disque de lames et est fournie avec bâche de protection, transmission primaire à engrenages à bain d'huile, transmission secondaire par joint de cardan et attelage aux trois points du tracteur. Elle est disponible en plusieurs modèles, suivant les exigences de travail et la puissance du tracteur auquel elle doit être appliquée.

									
mod.	cod.	cm	HP	rpm/min	type	nr	cm	kg	
ZRF-TL 1000	1002590	100	18 - 40	540	T-20	6	138×129×64	140	
ZRF-TL 1150	1002591	115	18 - 40	540	T-20	8	145×129×64	160	

Versione laterale - Side version - Seitenversion - Versión lateral - Version latérale

Di serie	Standard equipment	Serienmässig	Estándar	De série
<ul style="list-style-type: none"> Scatola di trasmissione con ruota libera Trasmissione secondaria mediante giunto cardanico Cardano Protezioni antinfortunistiche conformi alla normativa CE 	<ul style="list-style-type: none"> Gearbox with freewheel clutch Universal joint secondary drive PTO drive shaft Protective equipment as per EC safety rules 	<ul style="list-style-type: none"> Getriebe mit integriertem Freilauf Sekundärtrieb mittels Kardangelenken Gelenkwelle Unfallschutz nach EU-Vorschriften 	<ul style="list-style-type: none"> Caja de transmisión con rueda libre Trasmissione secundaria con articulación de cardán Cardan Protecciones de seguridad de acuerdo con la norma CE 	<ul style="list-style-type: none"> Boîtier de transmission avec roue libre Transmission secondaire par joint de cardan Cardan Protections contre les accidents aux normes CE

ZRF-TL	SIDE-MOUNTED ROTARY MOWER
ZRF-TL	SEITEN TROMMELMÄHWERK FÜR TRAKTOREN
ZRF-TL	SEGADORA ROTATIVA LATERAL
ZRF-TL	ROTOFAUCHEUSE LATÉRALE



MOD	MOVEMENT MACHINE			
	cm		cm	
ZRF-TL 1000	65	72	variabile	variabile
ZRF-TL 1150	71	74	variabile	variabile

MOD	A	B	C	D	E
	cm	cm	cm	cm	cm
ZRF-TL 1000	185	90	138	65	129
ZRF-TL 1150	190	83	145	71	135

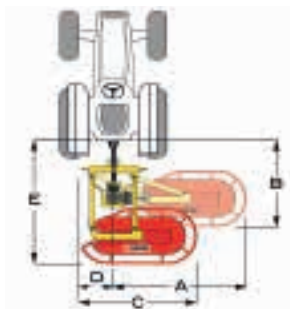

Funzionamento solo in posizione laterale
 Alone operation in side position
 Nur seitlich verwendbar
 Funcionamiento en posición lateral
 Opération seule dans la position latérale

cod.	Ricambi	Spare parts	Ersatzteile	Recambios	Pièces de rechange
5350001	Coltello	Knife	Schneide	Cuchilla	Couteau
5130031	Cardano T-20	Joint T-20	Gelenkwelle T-20	Cardan T-20	Cardan T-20
2020075	Scatola ingr. Mod. 1000/1150	Gearbox mod. 1000/1150	Getriebegehäuse mod. 1000/1150	Caia de engranajes mod. 1000/1150	Boîte d'engranages mod. 1000/1150
5105063	Albero trasmissione sec mod.1150	Universal joint sec. Drive mod.1150	Sek. Mittels kardangelen mod.1150	Transmisión secundaria mod.1150	Transmission secondaire mod.1150
5105064	Albero trasmissione sec mod.1000	Universal joint sec. Drive mod.1000	Sek. Mittels kardangelen mod.1000	Transmisión secundaria mod.1000	Transmission secondaire mod.1000
5107008	Albero PTO trattore	PTO shaft	PTO Welle	PTO arbol	PTO abre
5400027	Cuffia protezione cardano	Cardan protection	Schutzgelenkwelle	Protección de cardan	Protection cardan



ZRF-TL FALCIATRICE



SLE-8	<i>ELECTRIC LOG SPLITTER 8 t</i>
SLE-8	<i>STEHEND-HOLZSPALTER E-MOTOR 8 t</i>
SLE-8	<i>ASTILLADORA DE TRONCOS 8 t</i>
SLE-8	<i>FENDEUSE DE BÛCHES MOTEUR ELECTRIQUE 8 t</i>

Impiego: lo spaccalegna SLE-8 ha una spinta di 8 tonnellate e consente di spaccare tronchi di legno di dimensioni variabili, fino a 58 cm di altezza. È dotato di ruote per lo spostamento, di un ampio piano di lavoro rinforzato, di un sistema automatico di controllo finecorsa registrabile e di appositi dispositivi di sicurezza che tutelano l'utilizzatore.

Di serie: motore elettrico, pompa di notevole portata, distributore con portata 40 lt/min. con ritorno automatico del cassetto.

A richiesta: cuneo a croce.

Use: the SLE-8 log splitter has an 8 ton thrust and can split logs of various sizes, up to 58 cm in height. It is equipped with wheels for moving it, a large reinforced working table, an automatic adjustable "end-of-stroke control" system, and special safety devices that protect the user.

Standard equipment: electric motor, high capacity pump, distributor with flow rate of 40 l/min., with automatic piston return.

On request: cross wedge.

Verwendung: der Holzspalter SLE-8 hat eine Schubkraft von 8 Tonnen und kann Stämme verschiedener Größen mit einer Höhe von bis zu 58 cm spalten. Der Holzspalter ist mit Rädern zum Bewegen, einer großen verstärkten Arbeitsfläche, einer automatisch einstellbaren Endschaltersteuerung und speziellen Sicherheitsvorrichtungen zum Schutz des Benutzers ausgestattet.

Serienmäßig: Elektromotor, Hochleistungspumpe, Verteiler mit Fördermenge von 40 l/min. mit automatischem Kolbenrücklauf.

Auf Anfrage: Spaltkreuz.

Uso: la astilladora de troncos SLE-8 tiene un empuje de 8 toneladas y permite partir troncos de madera de dimensiones variables, hasta 58 cm de altura. Está dotada de ruedas para el desplazamiento, de un amplio plano de trabajo reforzado, de un sistema automático de "control final de carrera" ajustable y de adecuados dispositivos de seguridad que protegen al usuario.

Estándar: motor eléctrico, bomba de gran caudal, distribuidor con caudal 40 l/min, con retorno automático de la caja.

Opcionales: cuña en cruz.







Utilisation: la fendeuse de bûches SLE-8 a une poussée de 8 tonnes et permet de fendre des troncs de bois de dimensions variables, jusqu'à 58 cm de hauteur. Elle est dotée de roues pour le déplacement, d'un large plan de travail renforcé, d'un système automatique de "contrôle fin de course" réglable et de dispositifs de sécurité spécifiques qui protègent l'utilisateur.

De série: moteur électrique, pompe de grande portée, distributeur avec portée de 40 l/min. et retour automatique du tiroir.

Sur demande: coin à croix.



L'apparecchiatura è conforme ai requisiti richiesti dalla direttiva 2000/14/CE per la limitazione del rumore ambientale.
The equipment complies with the requirements of Directive 2000/14/EC for the limitation of environmental noise.

						
SCAN ME!						
mod.	cod.	ton	HP	cm	kg	cm
SLE-8 220 V	1002064	8	3	58	120	72×90×108
SLE-8 380 V - 4 POLI	1003851	8	3	58	120	72×90×108
SLE-8 380 V - 5 POLI	1003852	8	3	58	120	72×90×108

cod.	A richiesta	On request	Auf Anfrage	Opcionales	Sur demande
3350058	Cuneo a croce	Cross wedge	Spaltkreuz	Cuña en cruz	Coin à croix

cod.	Ricambi	Spare parts	Ersatzteile	Recambios	Pièces de rechange
5400014	Pattino guida superiore	Upper guide slide block	Obereführungskufe	Patín guía superior	Coulisseau guide supérieur
5400015	Pattino guida inferiore	Lower guide slide block	Untereführungskufe	Patín guía inferior	Coulisseau guide inférieur
5411012	Ruota SLE-8	Wheel SLE-8	Rad SLE-8	Rueda SLE-8	Roue SLE-8
5422001	Distributore oleodinamico	Distributor	Verteiler	Distribuidor hidráulico	Distributeur oléodynamique
5431020	Cilindro spaccalegna	Wood-splitting	Holzspaltzylinder multiplikator	Cilindro hendidora de troncos	Cylindre pour fendeuse de bûches
5023060	Motore elettrico 220V	220V electric motor	220V Elektromotor	Motor eléctrico 220V	Moteur électrique 220V
5023061	Motore elettrico 380V 4 Poli	Electric motor 380V 4 Poles	Elektromotor 380V 4-Polig	Motor eléctrico 380V 4 Polos	Moteur électrique 380V 4 Pôles
5023088	Motore elettrico 380V 5 Poli	Electric motor 380V 5 Poles	Elektromotor 380V 5-Polig	Motor eléctrico 380V 5 Polos	Moteur électrique 380V 5 Pôles
5421007	Pompa SLE-8	Pump SLE-8	Pumpe SLE-8	Bomba SLE-8	Pompe SLE-8
5444007	Interruttore con bobina	Switch with coil	Schalter mit spule	Interruptor con bobina	Interrupteur avec bobine
5444045	Condensatore motore el.220V	220V electric motor capacitor	220V Elektromotor Kondensator	Condensadores motor el. 220V	Condensateur de mot. él. 220V
5444046	Scatola condensatore SLE-8	Box capacitor SLE-8	Box Kondensator SLE-8	Caja de condensadores SLE-8	Boîtier de condensateur SLE-8

8 ton

SLS-8	PETROL ENGINE LOG SPLITTER 8 t
SLS-8	STEHEND-HOLZSPALTER BENZINMOTOR 8 t
SLS-8	ASTILLADORA DE TRONCOS 8 t
SLS-8	FENDEUSE DE BÛCHES AVEC MOTEUR ESSENCE 8 t

Impiego: lo spaccalegna SLS-8 ha una spinta di 8 tonnellate e consente di spaccare tronchi di legno di dimensioni variabili, fino a 58 cm di altezza. È dotato di ruote per lo spostamento, di un ampio piano di lavoro rinforzato, di un sistema automatico di controllo finecorsa registrabile e di appositi dispositivi di sicurezza che tutelano l'utilizzatore.

Di serie: motore (professionale) HONDA 6,5 HP, pompa di notevole portata, distributore con portata 40 lt/min. con ritorno automatico del cassetto.

A richiesta: cuneo a croce.

Use: the SLS-8 log splitter has an 8 ton thrust and can split logs of various sizes, up to 58 cm in height. It is equipped with wheels for moving it, a large reinforced working table, an automatic adjustable "end-of-stroke control" system, and special safety devices that protect the user.

Standard equipment: HONDA 6,5 HP (professional) motor, high capacity pump, distributor with flow rate of 40 l/min., with automatic piston return.

On request: cross wedge.

Verwendung: der Holzspalter SLS-8 hat eine Schubkraft von 8 Tonnen und kann Stämme verschiedener Größen mit einer Höhe von bis zu 58 cm spalten. Der Holzspalter ist mit Rädern zum Bewegen, einer großen verstärkten Arbeitsfläche, einer automatisch einstellbaren Endscharsteuerung und speziellen Sicherheitsvorrichtungen zum Schutz des Benutzers ausgestattet.

Serienmäßig: Benzinmotor Original HONDA 6,5 HP, Hochleistungspumpe, Verteiler mit Fördermenge von 40 l/min. mit automatischem Kolbenrücklauf.

Auf Anfrage: Spaltkreuz.

Uso: la astilladora de troncos SLS-8 tiene un empuje de 8 toneladas y permite partir troncos de madera de dimensiones variables, hasta 58 cm de altura. Está dotada de ruedas para el desplazamiento, de un amplio plano de trabajo reforzado, de un sistema automático de "control final de carrera" ajustable y de adecuados dispositivos de seguridad que protegen el usuario.

Estándar: motor (profesional) HONDA 6,5 HP, bomba de gran caudal, distribuidor con caudal 40 l/min, con retorno automático de la caja.

Opcionales: cuña en cruz.

Utilisation: la fendeuse de bûches SLS-8 a une poussée de 8 tonnes et permet de fendre des troncs de bois de dimensions variables, jusqu'à 58 cm de hauteur. Elle est dotée de roues pour le déplacement, d'un large plan de travail renforcé, d'un système automatique de "contrôle fin de course" réglable et de dispositifs de sécurité spécifiques qui protègent l'utilisateur.







De série: moteur (professionnel) HONDA 6,5 HP, pompe de grande portée, distributeur avec portée de 40 l/min et retour automatique du tiroir.

Sur demande: coin à croix.



L'apparecchiatura è conforme ai requisiti richiesti dalla direttiva 2000/14/CE per la limitazione del rumore ambientale.

The equipment complies with the requirements of Directive 2000/14/EC for the limitation of environmental noise.

						
mod.	cod.	ton	HP	cm	kg	cm
SLS-8	1002066	8	HONDA GP200 HP 6,5	58	125	72×115×108

cod.	A richiesta	On request	Auf Anfrage	Opcionales	Sur demande
3350058	Cuneo a croce	Cross wedge	Spaltkreuz	Cuña en cruz	Coin à croix

cod.	Ricambi	Spare parts	Ersatzteile	Recambios	Pièces de rechange
5400014	Pattino guida superiore	Upper guide slide block	Obereführungskufe	Patín guía superior	Coulisseau guide supérieur
5400015	Pattino guida inferiore	Lower guide slide block	Untereführungskufe	Patín guía inferior	Coulisseau guide inférieur
5411012	Ruota SLS-8	Wheel SLS-8	Rad SLS-8	Rueda SLS-8	Roue SLS-8
5422001	Distributore oleodinamico	Distributor	Verteiler	Distribuidor hidráulico	Distributeur oléodynamique
5431020	Cilindro spaccalegna	Wood-splitting	Holzspaltzylinder multiplikator	Cilindro hendidora de troncos	Cylindre pour fendeuse de bûches
5023113	Motore HONDA GP200 HP 6,5	Motor HONDA GP200 HP 6,5	Motor HONDA GP200 HP 6,5	Motor HONDA GP200 HP 6,5	Moteur HONDA GP200 HP 6,5
5421001	Pompa SLS-8	Pump SLS-8	Pumpe SLS-8	Bomba SLS-8	Pompe SLS-8
2131003	Accoppiamenti motore pompa	Motor - pump	Motor - pumpe	Motor-bomba	Mpteur-pompe



SLE-9	ELECTRIC ORIENTABLE LOG SPLITTER 9 t
SLE-9	SCHWENKBARER-HOLZSPALTER E-MOTOR 9 t
SLE-9	ASTILLADORA DE TRONCOS POLIVALENTE 9 t
SLE-9	FENDEUSE DE BÛCHES POLYVALENTE MOTEUR EL. 9 t

Impiego: lo spaccalegna SLE-9 ha una spinta di 9 tonnellate e consente di spaccare tronchi di legno di dimensioni variabili, fino a 59 cm di altezza. Grazie al meccanismo manuale è possibile lavorare in 3 diverse posizioni: verticale, orizzontale e a 45°. È dotato di ruote per lo spostamento, di un ampio piano di lavoro rinforzato, di un sistema automatico di controllo finecorsa registrabile e di appositi dispositivi di sicurezza che tutelano l'utilizzatore.

Di serie: motore elettrico, pompa di notevole portata, distributore con portata 40 lt/min. con velocità variabile e con ritorno automatico del cassetto.

A richiesta: cuneo a croce.

Use: the SLE-9 log splitter has an 9 ton thrust and can split logs of various sizes, up to 59 cm in height. The manual mechanism lets you work in 3 different positions: vertical, horizontal, and 45°. It is equipped with wheels for moving it, a large reinforced working table, an automatic adjustable "end-of-stroke control" system, and special safety devices that protect the user.

Standard equipment: electric motor, high capacity pump, distributor with flow rate of 40 l/min., variable speed, with automatic piston return.

On request: cross wedge.

Verwendung: der Holzspalter SLE-9 hat eine Schubkraft von 9 Tonnen und kann Stämme verschiedener Größen mit einer Höhe von bis zu 59 cm spalten. Das manuelle System erlaubt das Arbeiten in 3 verschiedenen Positionen, vertikal, horizontal und 45°. Der Holzspalter ist mit Rädern zum Bewegen, einer großen verstärkten Arbeitsfläche, einer automatisch einstellbaren Endschaltesteuerung und speziellen Sicherheitsvorrichtungen zum Schutz des Benutzers ausgestattet.

Serienmäßig: Elektromotor, Hochleistungspumpe, Verteiler mit Fördermenge von 40 l/min., variable Geschwindigkeit und mit automatischem Kolbenrücklauf.

Auf Anfrage: Spaltkreuz.

Uso: la astilladora de troncos SLE-9 tiene un empuje de 9 toneladas y permite partir troncos de madera de dimensiones variables, hasta 59 cm de altura. Gracias al mecanismo manual se puede trabajar en 3 distintas posiciones: vertical, horizontal y a 45°. Está dotada de ruedas para el desplazamiento, de un amplio plano de trabajo reforzado, de un sistema automático de "control final de carrera" ajustable y de adecuados dispositivos de seguridad que protegen el usuario.

Estándar: motor eléctrico, bomba de gran caudal, distribuidor con caudal 40 l/min, con velocidad variable y con retorno automático de la caja.

Opcionales: cuña en cruz.







Utilisation: la fendeuse de bûches SLE-9 a une poussée de 9 tonnes et permet de fendre des troncs de bois de dimensions variables, jusqu'à 59 cm de hauteur. Grâce au mécanisme manuel il est possible de travailler en 3 différentes positions : verticale, horizontale et à 45°. Elle est dotée de roues pour le déplacement, d'un large plan de travail renforcé, d'un système automatique de "contrôle fin de course" réglable et de dispositifs de sécurité spécifiques qui protègent l'utilisateur.

De série: moteur électrique, pompe de grande portée, distributeur avec portée de 40 l/min. et retour automatique du tiroir.

Sur demande: coin à croix.



L'apparecchiatura è conforme ai requisiti richiesti dalla direttiva 2000/14/CE per la limitazione del rumore ambientale.
The equipment complies with the requirements of Directive 2000/14/EC for the limitation of environmental noise.

						
mod.	cod.	ton	HP	cm	kg	cm
SLE-9 220 V	1002251	9	3	59	100	50×80×180
SLE-9 380 V - 4 POLI	1003853	9	3	59	100	50×80×180
SLE-9 380 V - 5 POLI	1003854	9	3	59	100	50×80×180

cod.	A richiesta	On request	Auf Anfrage	Opcionales	Sur demande
3350048	Cuneo a croce	Cross wedge	Spaltkreuz	Cuña en cruz	Coin à croix

cod.	Ricambi	Spare parts	Ersatzteile	Recambios	Pièces de rechange
8350092	Coltello	Knife	Schneide	Cuchilla	Couteau
5411010	Ruota SLE-9	Wheel SLE-9	Rad SLE-9	Rueda SLE-9	Roue SLE-9
5422003	Distributore oleodinamico	Distributor	Verteiler	Distribuidor hidráulico	Distributeur oléodynamique
5431021	Cilindro spaccalegna	Wood-splitting	Holzspaltzylinder multiplikator	Cilindro hendidora de troncos	Cylindre pour fendeuse de bûches
5023060	Motore elettrico 220V	220V electric motor	220V Elektromotor	Motor eléctrico 220V	Moteur électrique 220V
5023061	Motore elettrico 380V 4 Poli	Electric motor 380V 4 Poles	Elektromotor 380V 4-Polig	Motor eléctrico 380V 4 Polos	Moteur électrique 380V 4 Pôles
5023088	Motore elettrico 380V 5 Poli	Electric motor 380V 5 Poles	Elektromotor 380V 5-Polig	Motor eléctrico 380V 5 Polos	Moteur électrique 380V 5 Pôles
5421007	Pompa SLE-9	Pump SLE-9	Pumpe SLE-9	Bomba SLE-9	Pompe SLE-9
5444007	Interruttore con bobina	Switch with coil	Schalter mit spule	Interruptor con bobina	Interrupteur avec bobine
5444045	Condensatore motore el. 220V	220V electric motor capacitor	220V Elektromotor Kondensator	Condensadores motor el. 220V	Condensateur de mot. él. 220V
5444046	Scatola condensatore SLE-9	Box capacitor SLE-9	Box Kondensator SLE-9	Caja de condensadores SLE-9	Boîtier de condensateur SLE-9

9.5
ton

SLT-9.5	TRACTOR LOG SPLITTER 9.5 t
SLT-9.5	SCHWENKBARER-HOLZSPALTER ZAPFWELLENANTRIEB 9,5 t
SLT-9.5	ASTILLADORA DE TRONCOS DE 9,5 t CON TOMA DE FUERZA
SLT-9.5	FENDEUSE DE BÛCHES POLYVALENTE AVEC PDF TRACTEUR 9,5 t

Impiego: lo spaccalegna SLT-9.5 ha una spinta di 9,5 tonnellate e consente di spaccare tronchi di legno di dimensioni variabili, fino a 59 cm di altezza. Grazie al meccanismo manuale è possibile lavorare in 3 diverse posizioni: verticale, orizzontale e a 45°. È dotato di ruote per lo spostamento, di un ampio piano di lavoro rinforzato, di un sistema automatico di controllo finecorsa registrabile e di appositi dispositivi di sicurezza che tutelano l'utilizzatore.

Di serie: scatola ingranaggi a bagno d'olio, pompa con portata 14 l/min., distributore oleodinamico con portata 40 l/min. con ritorno automatico del cassetto.

A richiesta: pompa con rotazione sx, cuneo a croce.

Use: the SLT-9.5 log splitter has an 9,5 ton thrust and can split logs of various sizes, up to 59 cm in height. The manual mechanism lets you work in 3 different positions: vertical, horizontal, and 45°. It is equipped with wheels for moving it, a large reinforced working table, an automatic adjustable "end-of-stroke control" system, and special safety devices that protect the user.

Standard equipment: oil bath gearbox, pump with flow rate of 14 l/min., hydraulic distributor with flow rate of 40 l/min. with automatic valve return.

On request: pump with left rotation, cross wedge.

Verwendung: der Holzspalter SLT-9.5/SLI-9.5 hat eine Schubkraft von 9,5 Tonnen und kann Stämme verschiedener Größen mit einer Höhe von bis zu 59 cm spalten. Das manuelle System erlaubt das Arbeiten in 3 verschiedenen Positionen, vertikal, horizontal und 45°. Der Holzspalter ist mit Rädern zum Bewegen, einer großen verstärkten Arbeitsfläche, einer automatisch einstellbaren Endschaltersteuerung und speziellen Sicherheitsvorrichtungen zum Schutz des Benutzers ausgestattet.

Serienmäßig: Getriebeöl gefüllt, Pumpe mit Förderleistung 14 l/min. und hydraulischer Verteiler mit einer Förderleistung von 40 l/min. mit automatischem Ventilrücklauf.

Auf Anfrage: Pumpe mit Linksdrehung und Spaltkreuz.

Uso: la astilladora de troncos SLT-9.5 tiene un empuje de 9,5 toneladas y permite partir troncos de madera de dimensiones variables, hasta 59 cm de altura. Gracias al mecanismo manual se puede trabajar en 3 distintas posiciones: vertical, horizontal y a 45°. Está dotada de ruedas para el desplazamiento, de un amplio plano de trabajo reforzado, de un sistema automático de "control final de carrera" ajustable y de adecuados dispositivos de seguridad que protegen el usuario.

Estándar: caja de engranajes en baño de aceite, bomba con caudal 14 l/min, distribuidor hidráulico con caudal 40 l/min, con retorno automático de la caja.







Opcionales: bomba con rotación izquierda, cuña en cruz.

Utilisation: la fendeuse de bûches SLT-9.5 a une poussée de 9,5 tonnes et permet de fendre des troncs de bois de dimensions variables, jusqu'à 59 cm de hauteur. Grâce au mécanisme manuel il est possible de travailler en 3 différentes positions: verticale, horizontale et à 45°. Elle est dotée de roues pour le déplacement, d'un large plan de travail renforcé, d'un système automatique de "contrôle fin de course" réglable et de dispositifs de sécurité spécifiques qui protègent l'utilisateur.

De série: boîtier engrenages à bain d'huile, pompe avec portée 14 l/min, distributeur oléodynamique avec portée 40 l/min et retour automatique du tiroir.

Sur demande: pompe avec rotation à gauche, coin à croix.



						
SCAN ME!		ton	HP	cm	kg	cm
mod.	cod.	ton	HP	cm	kg	cm
SLT-9.5	1002252	9,5	18 - 60	59	95	50×80×180

cod.	A richiesta	On request	Auf Anfrage	Opcionales	Sur demande
5421004	Pompa con rotazione sx	Pump with left rotation	Pumpe mit rotation links	Bomba con rotación izquierda	Pompe avec rotation à gauche
3350048	Cuneo a croce	Cross wedge	Spaltkreuz	Cuña en cruz	Coin à croix

cod.	Ricambi	Spare parts	Ersatzteile	Recambios	Pièces de rechange
8350092	Coltello	Knife	Schneide	Cuchilla	Couteau
5411012	Ruota SLT-9.5	Wheel SLT-9.5	Rad SLT-9.5	Rueda SLT-9.5	Roue SLT-9.5
5422003	Distributore oleodinamico	Distributor	Verteiler	Distribuidor hidráulico	Distributeur oléodynamique
5431021	Cilindro spaccalegna	Wood-splitting	Holzspaltzylinder multiplikator	Cilindro hendidora de troncos	Cylindre pour fendeuse de bûches
5421003	Pompa	Pump	Pumpe	Bomba	Pompe
5132002	Moltiplicatore attacco rapido	Quick connect multiplier	Schnellanschluss	Multiplicador conexión rápida	Multiplicateur attelage rapide



Piano di lavoro mobile
Working table adjustable
Beweglicher Arbeitstisch
Superficie de trabajo regulable
Plan de travail réglable



SLE-10	ELECTRIC LOG SPLITTER 10 t
SLE-10	STEHEND-HOLZSPALTER E-MOTOR 10 t
SLE-10	ASTILLADORA DE TRONCOS ELÉCTRICA 10 t
SLE-10	FENDEUSE DE BÛCHES MOTEUR ELECTRIQUE 10 t

Impiego: lo spaccalegna SLE-10 ha una spinta di 10 tonnellate e consente di spaccare tronchi di legno di dimensioni variabili, fino a 90 cm di altezza. È dotato di ruote per lo spostamento, di un ampio piano di lavoro rinforzato, di un sistema automatico di controllo finecorsa registrabile e di appositi dispositivi di sicurezza che tutelano l'utilizzatore.

Di serie: motore elettrico, pompa doppia compatta con valvola disgiuntrice 2+6, distributore oleodinamico di notevole portata con ritorno automatico del cassetto.

A richiesta: cuneo a croce.

Use: the SLE-10 log splitter has an 10 ton thrust and can split logs of various sizes, up to 90 cm in height. It is equipped with wheels for moving it, a large reinforced working table adjustable in 3 positions, an automatic adjustable "end-of-stroke control" system, and special safety devices that protect the user.

Standard equipment: electric motor, compact double pump with 2+6 disconnection valve, high capacity hydraulic distributor with automatic piston return.

On request: cross wedge.

Verwendung: der Holzspalter SLE-10 hat eine Schubkraft von 10 Tonnen und kann Stämme verschiedener Größen mit einer Höhe von bis zu 90 cm spalten. Der Holzspalter ist mit Rädern zum Bewegen, einer großen verstärkten Arbeitsfläche, einer automatisch einstellbaren Endschaltersteuerung und speziellen Sicherheitsvorrichtungen zum Schutz des Benutzers ausgestattet.

Serienmäßig: Elektromotor, Pumpe mit Leistungsschalterventil 2+6 und Hochleistungs-Hydraulikverteiler mit automatischem Kolbenrücklauf.

Auf Anfrage: Spaltkreuz.

Uso: la astilladora de troncos SLE-10 tiene un empuje de 10 toneladas y permite partir troncos de madera de dimensiones variables, hasta 90 cm de altura. Está dotada de ruedas para el desplazamiento, de un amplio plano de trabajo reforzado ajustable en 3 posiciones, de un sistema automático de "control final de carrera" ajustable y de adecuados dispositivos de seguridad que protegen al usuario.

Estándar: motor eléctrico, bomba doble compacta con válvula de corte 2+6, distribuidor hidráulico de gran caudal, con retorno automático de la caja.

Opcionales: cuña en cruz.





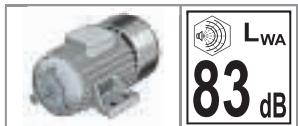

Utilisation: la fendeuse de bûches SLE-10 a une poussée de 10 tonnes et permet de fendre des troncs de bois de dimensions variables, jusqu'à 90 cm de hauteur. Elle est dotée de roues pour le déplacement, d'un large plan de travail renforcé réglable en 3 positions, d'un système automatique de "contrôle fin de course" réglable et de dispositifs de sécurité spécifiques qui protègent l'utilisateur.

De série: moteur électrique, pompe double compacte avec vannes de disjonction 2+6, distributeur oléodynamique de grande portée avec retour automatique du tiroir.

Sur demande: coin à croix.



L'apparecchiatura è conforme ai requisiti richiesti dalla direttiva 2000/14/CE per la limitazione del rumore ambientale.
The equipment complies with the requirements of Directive 2000/14/EC for the limitation of environmental noise.

						
mod.	cod.	ton	HP	cm	kg	cm
SLE-10 mobile 220 V	1002062	10	3	90	150	72×90×108
SLE-10 mobile 380 V - 4 POLI	1003855	10	3	90	150	72×90×108
SLE-10 mobile 380 V - 5 POLI	1003856	10	3	90	150	72×90×108

cod.	A richiesta	On request	Auf Anfrage	Opcionales	Sur demande
3350058	Cuneo a croce	Cross wedge	Spaltkreuz	Cuña en cruz	Coin à croix

cod.	Ricambi	Spare parts	Ersatzteile	Recambios	Pièces de rechange
5400014	Pattino guida superiore	Upper guide slide block	Obereführungskufe	Patín guía superior	Coulisseau guide supérieur
5400015	Pattino guida inferiore	Lower guide slide block	Untereführungskufe	Patín guía inferior	Coulisseau guide inférieur
5422001	Distributore oleodinamico	Distributor	Verteiler	Distribuidor hidráulico	Distributeur oléodynamique
5431020	Cilindro spaccalegna	Wood-splitting	Holzspaltzylinder multiplikator	Cilindro hendidora de troncos	Cylindre pour fendeuse de bûches
5023060	Motore elettrico 220V	220V electric motor	220V Elektromotor	Motor eléctrico 220V	Moteur électrique 220V
5023061	Motore elettrico 380V 4 Poli	Electric motor 380V 4 Poles	Elektromotor 380V 4-Polig	Motor eléctrico 380V 4 Polos	Moteur électrique 380V 4 Pôles
5023088	Motore elettrico 380V 5 Poli	Electric motor 380V 5 Poles	Elektromotor 380V 5-Polig	Motor eléctrico 380V 5 Polos	Moteur électrique 380V 5 Pôles
5421008	Pompa doppia	Double pump	Dopplepumpe	Bomba doble	Pompe double
5444007	Interruttore con bobina	Switch with coil	Schalter mit spule	Interruptor con bobina	Interrupteur avec bobine
5444045	Condensatore motore el. 220V	220V electric motor capacitor	220V Elektromotor Kondensator	Condensadores motor el. 220V	Condensateur de mot. él. 220V
5444046	Scatola condensatore SLE-10	Box capacitor SLE-10	Box Kondensator SLE-10	Caja de condensadores SLE-10	Boîtier de condensateur SLE-10



Piano di lavoro fisso
Fixed worktop
Fester Arbeitstisch
Superficie de trabajo fija
Plan de travail entreprise

SLE-10	<i>ELECTRIC LOG SPLITTER 10 t</i>
SLE-10	<i>STEHEND-HOLZSPALTER E-MOTOR 10 t</i>
SLE-10	<i>ASTILLADORA DE TRONCOS ELÉCTRICA 10 t</i>
SLE-10	<i>FENDEUSE DE BÛCHES MOTEUR ELECTRIQUE 10 t</i>

Impiego: lo spaccalegna SLE-10 ha una spinta di 10 tonnellate e consente di spaccare tronchi di legno di dimensioni variabili, fino a 57 cm di altezza. È dotato di ruote per lo spostamento, di un ampio piano di lavoro rinforzato, di un sistema automatico di controllo finecorsa registrabile e di appositi dispositivi di sicurezza che tutelano l'utilizzatore.

Di serie: motore elettrico, pompa doppia compatta con valvola disgiuntrice 2+6, distributore oleodinamico di notevole portata con ritorno automatico del cassetto.

A richiesta: cuneo a croce.

Use: the SLE-10 log splitter has an 10 ton thrust and can split logs of various sizes, up to 57 cm in height. It is equipped with wheels for moving it, a large reinforced working table, an automatic adjustable "end-of-stroke control" system, and special safety devices that protect the user.

Standard equipment: electric motor, compact double pump with 2+6 disconnection valve, high capacity hydraulic distributor with automatic piston return.

On request: cross wedge.

Verwendung: der Holzspalter SLE-10 hat eine Schubkraft von 10 Tonnen und kann Stämme verschiedener Größen mit einer Höhe von bis zu 57 cm spalten. Der Holzspalter ist mit Rädern zum Bewegen, einer großen verstärkten Arbeitsfläche, einer automatisch einstellbaren Endschaltersteuerung und speziellen Sicherheitsvorrichtungen zum Schutz des Benutzers ausgestattet.

Serienmäßig: Elektromotor, Pumpe mit Leistungsschalterventil 2+6 und Hochleistungs-Hydraulikverteiler mit automatischem Kolbenrücklauf.

Auf Anfrage: Spaltkreuz.

Uso: la astilladora de tronco SLE-10 tiene un empuje de 10 toneladas y permite partir troncos de madera de dimensiones variables, hasta 57 cm de altura. Está dotada de ruedas para el desplazamiento, de un amplio plano de trabajo reforzado, de un sistema automático de "control final de carrera" ajustable y de adecuados dispositivos de seguridad que protegen al usuario.

Estándar: motor eléctrico, bomba doble compacta con válvula de corte 2+6, distribuidor hidráulico de gran caudal, con retorno automático de la caja.

Opcionales: cuña en cruz.

Utilisation: la fendeuse de bûches SLE-10 a une poussée de 10 tonnes et permet de fendre des troncs de bois de dimensions variables, jusqu'à 57 cm de hauteur. Elle est dotée de roues pour le déplacement, d'un large plan de travail renforcé, d'un système automatique de "contrôle fin de course" réglable et de dispositifs de sécurité spécifiques qui protègent l'utilisateur.

De série: moteur électrique, pompe double compacte avec vannes de disjonction 2+6, distributeur oléodynamique de grande portée avec retour automatique du tiroir.

Sur demande: coin à croix.



L'apparechiatura è conforme ai requisiti richiesti dalla direttiva 2000/14/CE per la limitazione del rumore ambientale.
The equipment complies with the requirements of Directive 2000/14/EC for the limitation of environmental noise.

mod.	cod.	ton	HP	cm	kg	cm
SLE-10 fisso 220 V	1002468	10	3	57	125	72×90×108
SLE-10 fisso 380 V - 4 POLI	1003857	10	3	57	125	72×90×108
SLE-10 fisso 380 V - 5 POLI	1003858	10	3	57	125	72×90×108

cod.	A richiesta	On request	Auf Anfrage	Opcionales	Sur demande
3350058	Cuneo a croce	Cross wedge	Spaltkreuz	Cuña en cruz	Coin à croix

cod.	Ricambi	Spare parts	Ersatzteile	Recambios	Pièces de rechange
5400014	Pattino guida superiore	Upper guide slide block	Obereführungskufe	Patín guía superior	Coulisseau guide supérieur
5400015	Pattino guida inferiore	Lower guide slide block	Untereführungskufe	Patín guía inferior	Coulisseau guide inférieur
5422001	Distributore oleodinamico	Distributor	Verteiler	Distribuidor hidráulico	Distributeur oléodynamique
5431020	Cilindro spaccalegna	Wood-splitting	Holzspaltzylinder multiplikator	Cilindro hendidora de troncos	Cylindre pour fendeuse de bûches
5023060	Motore elettrico 220V	220V electric motor	220V Elektromotor	Motor eléctrico 220V	Moteur électrique 220V
5023061	Motore elettrico 380V 4 Poli	Electric motor 380V 4 Poles	Elektromotor 380V 4-Polig	Motor eléctrico 380V 4 Polos	Moteur électrique 380V 4 Pôles
5023088	Motore elettrico 380V 5 Poli	Electric motor 380V 5 Poles	Elektromotor 380V 5-Polig	Motor eléctrico 380V 5 Polos	Moteur électrique 380V 5 Pôles
5421008	Pompa doppia	Double pump	Dopplepumpe	Bomba doble	Pompe double
5444007	Interruttore con bobina	Switch with coil	Schalter mit spule	Interruptor con bobina	Interrupteur avec bobine
5444045	Condensatore motore el. 220V	220V electric motor capacitor	220V Elektromotor Kondensator	Condensadores motor el. 220V	Condensateur de mot. él. 220V
5444046	Scatola condensatore SLE-10	Box capacitor SLE-10	Box Kondensator SLE-10	Caja de condensadores SLE-10	Boîtier de condensateur SLE-10



SLT-10	TRACTOR LOG SPLITTER 10 t
SLT-10	STEHEND-HOLZSPALTER ZAPFWELLENANTRIEB 10 t
SLT-10	ASTILLADORA DE TRONCOS HIDRÁULICA 10 t
SLT-10	FENDEUSE DE BÛCHES PDF TRACTEUR 10 t

Impiego: lo spaccalegna SLT-10 ha una spinta di 10 tonnellate e consente di spaccare tronchi di legno di dimensioni variabili, fino a 90 cm di altezza. È dotato di ruote per lo spostamento, di un ampio piano di lavoro rinforzato, di un sistema automatico di controllo finecorsa registrabile e di appositi dispositivi di sicurezza che tutelano l'utilizzatore.

Di serie: scatola ingranaggi a bagno d'olio, pompa con portata 14 l/min., distributore oleodinamico con portata 40 l/min. con ritorno automatico del cassetto.

A richiesta: pompa con rotazione sx, cuneo a croce.

Use: the SLT-10 log splitter has an 10 ton thrust and can split logs of various sizes, up to 90 cm in height. It is equipped with wheels for moving it, a large reinforced working table adjustable in 3 positions, an automatic adjustable "end-of-stroke control" system, and special safety devices that protect the user.

Standard equipment: oil filled pump with flow rate of 14 l/min., hydraulic distributor with flow rate of 40 l/min., with automatic piston return.

On request: pump with left rotation, cross wedge.

Verwendung: der Holzspalter SLT-10 hat eine Schubkraft von 10 Tonnen und kann Stämme verschiedener Größen mit einer Höhe von bis zu 90 cm spalten. Der Holzspalter ist mit Rädern zum Bewegen, einer großen verstärkten Arbeitsfläche, einer automatisch einstellbaren Endschaltersteuerung und speziellen Sicherheitsvorrichtungen zum Schutz des Benutzers ausgestattet.

Serienmäßig: Getriebeöl gefüllt, Pumpe mit Förderleistung 14 l/min. und hydraulischer Verteiler mit einer Förderleistung von 40 l/min. mit automatischem Ventilrücklauf.

Auf Anfrage: Pumpe mit Linksdrehung und Spaltkreuz.

Uso: la astilladora de troncos SLT-10 tiene un empuje de 10 toneladas y permite partir troncos de madera de dimensiones variables, hasta 90 cm de altura. Está dotada de ruedas para el desplazamiento, de un amplio plano de trabajo reforzado ajustable en 3 posiciones, de un sistema automático de "control final de carrera" ajustable y de adecuados dispositivos de seguridad que protegen el usuario.

Estándar: caja de engranajes en baño de aceite, bomba con caudal 14 l/min, distribuidor hidráulico con caudal 40 l/min, con retorno automático de la caja.

Opcionales: bomba con rotación izquierda, cuña en cruz.

Utilisation: la fendeuse de bûches SLT-10 a une poussée de 10 tonnes et permet de fendre des troncs de bois de dimensions variables, jusqu'à 90 cm de hauteur. Elle est dotée de roues pour le déplacement, d'un large plan de travail renforcé réglable en 3 positions, d'un système automatique de "contrôle fin de course" réglable et de dispositifs de sécurité spécifiques qui protègent l'utilisateur.

De série: boîtier engrenages à bain d'huile, pompe avec portée 14 l/min, distributeur oléodynamique avec portée 40 l/min et retour automatique du tiroir







Sur demande: pompe avec rotation à gauche, coin à croix.



Piano di lavoro mobile
Working table adjustable
Beweglicher Arbeitstisch
Superficie de trabajo regulable
Plan de travail réglable

SLT-10



						
mod.	cod.	ton	HP	cm	kg	cm
SLT-10 mobile	1002063	10	20 - 60	90	145	72×90×108

cod.	A richiesta	On request	Auf Anfrage	Opcionales	Sur demande
5421004	Pompa con rotazione sx	Pump with left rotation	Pumpe mit rotation links	Bomba con rotación izquierda	Pompe avec rotation à gauche
3350058	Cuneo a croce	Cross wedge	Spaltkreuz	Cuña en cruz	Coin à croix

cod.	Ricambi	Spare parts	Ersatzteile	Recambios	Pièces de rechange
5400014	Pattino guida superiore	Upper guide slide block	Obereführungskufe	Patín guía superior	Coulisseau guide supérieur
5400015	Pattino guida inferiore	Lower guide slide block	Untereführungskufe	Patín guía inferior	Coulisseau guide inférieur
5411012	Ruota	Wheel	Rad	Rueda	Roue
5422001	Distributore oleodinamico	Distributor	Verteiler	Distribuidor hidráulico	Distributeur oléodynamique
5431020	Cilindro spaccalegna	Wood-splitting	Holzspaltzylinder multiplikator	Cilindro hendidora de troncos	Cylindre pour fendeuse de bûches
5421003	Pompa	Pump	Pumpe	Bomba	Pompe
5132002	Moltiplicatore attacco rapido	Quick connect multiplier	Schnellanschluss	Multiplicador conexión rápida	Multiplicateur attelage rapide



SLT-10	TRACTOR LOG SPLITTER 10 t
SLT-10	STEHEND-HOLZSPALTER ZAPFWELLENANTRIEB 10 t
SLT-10	ASTILLADORA DE TRONCOS HIDRÁULICA 10 t
SLT-10	FENDEUSE DE BÛCHES PDF TRACTEUR 10 t

Impiego: lo spaccalegna SLT-10 ha una spinta di 10 tonnellate e consente di spaccare tronchi di legno di dimensioni variabili, fino a 58 cm di altezza. È dotato di ruote per lo spostamento, di un ampio piano di lavoro rinforzato, di un sistema automatico di controllo finecorsa registrabile e di appositi dispositivi di sicurezza che tutelano l'utilizzatore.

Di serie: Scatola ingranaggi a bagno d'olio, pompa con portata 14 l/min., distributore oleodinamico con portata 40 l/min. con ritorno automatico del cassetto.

A richiesta: Pompa con rotazione sx, cuneo a croce.

Use: the SLT-10 log splitter has an 9 ton thrust and can split logs of various sizes, up to 58 cm in height. It is equipped with wheels for moving it, a large reinforced working table, an automatic adjustable "end-of-stroke control" system, and special safety devices that protect the user.

Standard equipment: Gearbox in oil filled, pump with flow rate of 14 l/min., hydraulic distributor with flow rate of 40 l/min., with automatic piston return.

On request Pump with left rotation, cross wedge.

Verwendung: der Holzspalter SLT-10 hat eine Schubkraft von 10 Tonnen und kann Stämme verschiedener Größen mit einer Höhe von bis zu 58 cm spalten. Der Holzspalter ist mit Rädern zum Bewegen, einer großen verstärkten Arbeitsfläche, einer automatisch einstellbaren Endschaltersteuerung und speziellen Sicherheitsvorrichtungen zum Schutz des Benutzers ausgestattet.

Serienmäßig: Getriebeöl gefüllt, Pumpe mit Förderleistung 14 l/min. und hydraulischer Verteiler mit einer Förderleistung von 40 l/min. mit automatischem Ventilrücklauf.

Auf Anfrage: Pumpe mit Linksdrehung und Spaltkreuz.

Uso: la astilladora de troncos SLT-10 tiene un empuje de 10 toneladas y permite partir troncos de madera de dimensiones variables, hasta 58 cm de altura. Está dotada de ruedas para el desplazamiento, de un amplio plano de trabajo reforzado, de un sistema automático de "control final de carrera" ajustable y de adecuados dispositivos de seguridad que protegen el usuario.

Estándar: Caja de engranajes en baño de aceite, bomba con caudal 14 l/min, distribuidor hidráulico con caudal 40 l/min, con retorno automático de la caja.

Opcionales Bomba con rotación izquierda, cuña en cruz.

Utilisation: la fendeuse de bûches SLT-10 a une poussée de 10 tonnes et permet de fendre des troncs de bois de dimensions variables, jusqu'à 58 cm de hauteur. Elle est dotée de roues pour le déplacement, d'un large plan de travail renforcé, d'un système automatique de "contrôle fin de course" réglable et de dispositifs de sécurité spécifiques qui protègent l'utilisateur.

De série: Boîtier engrenages à bain d'huile, pompe avec portée 14 l/min, distributeur oléodynamique avec portée 40 l/min et retour automatique du tiroir.

Sur demande: Pompe avec rotation à gauche, coin à croix.



Piano di lavoro fisso
Fixed worktop
Fester Arbeitstisch
Superficie de trabajo fija
Plan de travail entreprise

SLT-10



mod.	cod.	ton	HP	cm	kg	cm
SLT-10 fisso	1002898	10	20 - 60	57	115	72×90×108

cod.	A richiesta	On request	Auf Anfrage	Opcionales	Sur demande
5421004	Pompa con rotazione sx	Pump with left rotation	Pumpe mit rotation links	Bomba con rotación izquierda	Pompe avec rotation à gauche
3350058	Cuneo a croce	Cross wedge	Spaltkreuz	Cuña en cruz	Coin à croix

cod.	Ricambi	Spare parts	Ersatzteile	Recambios	Pièces de rechange
5400014	Pattino guida superiore	Upper guide slide block	Obereführungskufe	Patín guía superior	Coulisseau guide supérieur
5400015	Pattino guida inferiore	Lower guide slide block	Untereführungskufe	Patín guía inferior	Coulisseau guide inférieur
5411012	Ruota	Wheel	Rad	Rueda	Roue
5422001	Distributore oleodinamico	Distributor	Verteiler	Distribuidor hidráulico	Distributeur oléodynamique
5431020	Cilindro spaccalegna	Wood-splitting	Holzspaltzylinder multiplikator	Cilindro hendidora de troncos	Cylindre pour fendeuse de bûches
5421003	Pompa	Pump	Pumpe	Bomba	Pompe
5132002	Moltiplicatore attacco rapido	Quick connect multiplier	Schnellanschluss	Multiplicador conexión rápida	Multiplicateur attelage rapide

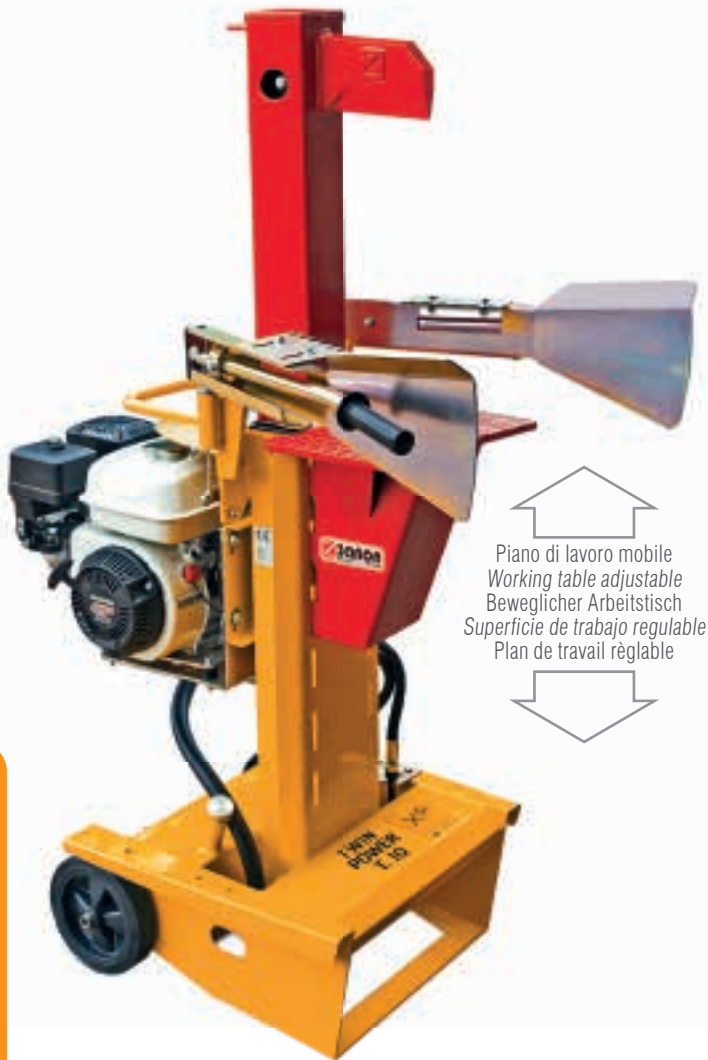

Piano di lavoro mobile
Working table adjustable
Beweglicher Arbeitstisch
Superficie de trabajo regulable
Plan de travail réglable

SLS-10	PETROL ENGINE LOG SPLITTER 10 t
SLS-10	STEHEND-HOLZSPALTER BENZINMOTOR 10 t
SLS-10	ASTILLADORA DE TRONCOS 10 t
SLS-10	FENDEUSE DE BÛCHES AVEC MOTEUR ESSENCE 10 t

Impiego: lo spaccalegna SLS-10 ha una spinta di 10 tonnellate e consente di spaccare tronchi di legno di dimensioni variabili, fino a 90 cm di altezza. È dotato di ruote per lo spostamento, di un ampio piano di lavoro rinforzato, di un sistema automatico di controllo finecorsa registrabile e di appositi dispositivi di sicurezza che tutelano l'utilizzatore.

Di serie: Motore HONDA (6,5HP), pompa doppia compatta con valvola disgiuntiva 2+6, distributore oleodinamico di notevole portata con ritorno automatico del cassetto.

A richiesta: cuneo a croce.

Use: the SLS-10 log splitter has an 10 ton thrust and can split logs of various sizes, up to 90 cm in height. It is equipped with wheels for moving it, a large reinforced working table adjustable in 3 positions, an automatic adjustable "end-of-stroke control" system, and special safety devices that protect the user.

Standard equipment: HONDA 6,5 HP (professional) motor, compact double pump with 2+6 disconnection valve, high capacity hydraulic distributor with automatic piston return.

On request: cross wedge.

Verwendung: der Holzspalter SLS-10 hat eine Schubkraft von 10 Tonnen und kann Stämme verschiedener Größen mit einer Höhe von bis zu 90 cm spalten. Der Holzspalter ist mit Rädern zum Bewegen, einer großen verstärkten Arbeitsfläche, einer automatisch einstellbaren Endschaltersteuerung und speziellen Sicherheitsvorrichtungen zum Schutz des Benutzers ausgestattet.

Serienmäßig: Benzinmotor Original HONDA 6,5 HP, kompakte Doppelpumpe mit 2+6 Trennventil und Hochleistungs-Hydraulikverteiler mit automatischem Kolbenrücklauf.

Auf Anfrage: Spaltkreuz.

Uso: la astilladora de troncos SLS-10 tiene un empuje de 10 toneladas y permite partir troncos de madera de dimensiones variables, hasta 90 cm de altura. Está dotada de ruedas para el desplazamiento, de un amplio plano de trabajo reforzado ajustable en 3 posiciones, de un sistema automático de "control final de carrera" ajustable y de adecuados dispositivos de seguridad que protegen el usuario.

Estándar: motor profesional HONDA (6,5 HP), bomba doble compacta con válvula de corte 2+6, distribuidor hidráulico de gran caudal, con retorno automático de la caja.

Opcionales: cuña en cruz.







Utilisation: la fendeuse de bûches SLS-10 a une poussée de 10 tonnes et permet de fendre des trunks de bois de dimensions variables, jusqu'à 90 cm de hauteur. Elle est dotée de roues pour le déplacement, d'un large plan de travail renforcé réglable en 3 positions, d'un système automatique de "contrôle fin de course" réglable et de dispositifs de sécurité spécifiques qui protègent l'utilisateur.

De série: moteur professionnel HONDA (6,5 HP), pompe double compacte avec vannes de disjonction 2+6, distributeur oléodynamique de grande portée avec retour automatique du tiroir.

Sur demande: coin à croix.



L'apparecchiatura è conforme ai requisiti richiesti dalla direttiva 2000/14/CE per la limitazione del rumore ambientale.
The equipment complies with the requirements of Directive 2000/14/EC for the limitation of environmental noise.

						
mod.	cod.	ton	HP	cm	kg	cm
SLS-10	1002389	10	HONDA GP 200 HP 6,5	90	155	72×115×108

cod.	A richiesta	On request	Auf Anfrage	Opcionales	Sur demande
3350058	Cuneo a croce	Cross wedge	Spaltkreuz	Cuña en cruz	Coin à croix

cod.	Ricambi	Spare parts	Ersatzteile	Recambios	Pièces de rechange
5400014	Pattino guida superiore	Upper guide slide block	Obereführungskufe	Patín guía superior	Coulisseau guide supérieur
5400015	Pattino guida inferiore	Lower guide slide block	Untereführungskufe	Patín guía inferior	Coulisseau guide inférieur
5411012	Ruota SLS-10	Wheel SLS-10	Rad SLS-10	Rueda SLS-10	Roue SLS-10
5422001	Distributore oleodinamico	Distributor	Verteiler	Distribuidor hidráulico	Distributeur oléodynamique
5431020	Cilindro spaccalegna	Wood-splitting	Holzspaltzylinder multiplikator	Cilindro hendidora de troncos	Cylindre pour fendeuse de bûches
5023113	Motore HONDA GP 200 HP 6,5	Motor HONDA GP 200 HP 6,5	Motor HONDA GP 200 HP 6,5	Motor HONDA GP 200 HP 6,5	Moteur HONDA GP 200 HP 6,5
5421002	Pompa doppia	Double pump	Dopplepumpe	Bomba doble	Pompe double
2131003	Accoppiamenti motore pompa	Motor-pump	Motor-pumpe	Motor-bomba	Moteur-pompe



SVE-10/12	ELECTRIC LOG SPLITTER 10/12 t
SVE-10/12	STEHEND-HOLZSPALTER E-MOTOR 10/12 t
SVE-10/12	ASTILLADORA DE TRONCOS ELÉCTRICA 10/12 T
SVE-10/12	FENDEUSE DE BÛCHES MOTEUR ELECTRIQUE 10/12 t

Impiego: lo spaccalegna SVE-10/12 ha una spinta di 10 o 12 tonnellate e consente di spaccare tronchi di legno di dimensioni variabili, fino a 67 cm di altezza. È dotato di ruote per lo spostamento, di un ampio piano di lavoro rinforzato, di un sistema automatico di controllo finecorsa registrabile e di appositi dispositivi di sicurezza che tutelano l'utilizzatore. La linea di spaccalegna SVE è dedicata all'uso professionale. Ha una lama di grandi dimensioni e una doppia pompa che garantisce una spinta potente e velocità di lavoro. **Di serie:** motore elettrico, pompa con valvola disgiuntiva 2+6, distributore oleodinamico con portata 40 lt/min. con ritorno automatico del cassetto. **A richiesta:** cuneo a croce.

Use: the SVE-10/12 log splitter has an 10 or 12 ton thrust and can split logs of various sizes, up to 67 cm in height. It is equipped with wheels for moving it, a large reinforced working table adjustable in 3 positions, an automatic adjustable "end-of-stroke control" system, and special safety devices that protect the user. The SVE log splitter line is for professional use. It has a large blade and double pump that ensures powerful thrust and operating speed. **Standard equipment:** electric motor, pump with 2+6 disconnection valve, hydraulic distributor with flow rate of 40 l/min., with automatic piston return. **On request:** cross wedge.

Verwendung: der Holzspalter SVE-10/12 hat eine Schubkraft von 10 oder 12 Tonnen und kann Stämme verschiedener Größen mit einer Höhe von bis zu 67 cm spalten. Der Holzspalter ist mit Rädern zum Bewegen, einer automatisch einstellbaren Endschaltersteuerung und speziellen Sicherheitsvorrichtungen zum Schutz des Benutzers ausgestattet. Der SVE Holzspalter ist für den professionellen Einsatz bestimmt. Sie verfügt über eine große Klinge und eine Doppelpumpe, die einen starken Schub und eine hohe Arbeitsgeschwindigkeit gewährleistet. **Serienmäßig:** Elektromotor, Pumpe mit Leistungshalterventil 2+6, hydraulischer Verteiler mit einer Fördermenge von 40 l/min, mit automatischem Kolbenrücklauf. **Auf Anfrage:** Spaltkreuz.

Uso: la astilladora de troncos SVE-10/12 tiene un empuje de 10-12 toneladas y permite partir troncos de madera de dimensiones variables, hasta 67 cm de altura. Está dotada de ruedas para el desplazamiento, de un amplio plano de trabajo reforzado ajustable en 3 posiciones, de un sistema automático de "control final de carrera" ajustable y de adecuados dispositivos de seguridad que protegen al usuario. La línea de astilladoras de troncos SVE está dedicada al uso profesional. Tiene una cuchilla de grandes dimensiones y un bomba doble que garantiza un empuje potente y velocidad de trabajo. **Estándar:** motor eléctrico, bomba con válvula de corte 2+6, distribuidor hidráulico de gran caudal 40 l/min, con retorno automático de la caja. **Opcionales:** cuña en cruz.

Utilisation: la fendeuse de bûches SVE-10/12 a une poussée de 10-12 tonnes et permet de fendre des troncs de bois de dimensions variables, jusqu'à 67 cm de hauteur. Elle est dotée de roues pour le déplacement, d'un large plan de travail renforcé réglable en 3 positions, d'un système automatique de "contrôle fin de course" réglable et de dispositifs de sécurité spécifiques qui protègent l'utilisateur. La ligne de fendeuses à bois SVE est dédiée à l'usage professionnel. Elle a une lame de grandes dimensions et une pompe double qui garantit une poussée puissante et rapidité de travail. **De série:** moteur électrique, pompe avec vanne de disjonction 2+6, distributeur oléodynamique de portée 40 l/min avec retour automatique du tiroir. **Sur demande:** coin à croix.

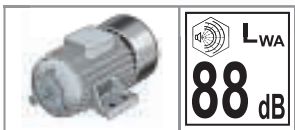

L'apparecchiatura è conforme ai requisiti richiesti dalla direttiva 2000/14/CE per la limitazione del rumore ambientale. The equipment complies with the requirements of Directive 2000/14/EC for the limitation of environmental noise.

mod.	cod.	ton	HP	cm	kg	cm
SVE-10/390 220 V	1002230	10	3	67	185	68×112×208
SVE-10/390 380 V - 4 POLI	1003859	10	3	67	185	68×112×208
SVE-10/390 380 V - 5 POLI	1003860	10	3	67	185	68×112×208
SVE-12/670 220 V	1002231	12	3	67	195	68×112×208
SVE-12/670 380 V - 4 POLI	1003861	12	3	67	195	68×112×208
SVE-12/670 380 V - 5 POLI	1003862	12	3	67	195	68×112×208

cod.	A richiesta	On request	Auf Anfrage	Opcionales	Sur demande
3350051	Cuneo a croce	Cross wedge	Spaltkreuz	Cuña en cruz	Coin à croix

cod.	Ricambi	Spare parts	Ersatzteile	Recambios	Pièces de rechange
8350078	Coltello	Knife	Schneide	Cuchilla	Couteau
5422004	Distributore oleodinamico	Distributor	Verteiler	Distribuidor hidráulico	Distributeur oléodynamique
5431005	Cilindro spaccalegna 390 (10 t)	Wood-splitting 390 (10 t)	Holzspaltzylinder m. 390 (10 t)	Cilindro hendidora 390 (10 t)	Cylindre pour fen. 390 (10 t)
5431008	Cilindro spaccalegna 670 (12 t)	Wood-splitting 670 (12 t)	Holzspaltzylinder m. 670 (12 t)	Cilindro hendidora 670 (12 t)	Cylindre pour fen. 670 (12 t)
5023001	Motore elettrico 220V	220V electric motor	220V Elektromotor	Motor eléctrico 220V	Moteur électrique 220V
5023039	Motore elettrico 380V 4 Poli	Electric motor 380V 4 Poles	Elektromotor 380V 4-Polig	Motor eléctrico 380V 4 Polos	Moteur électrique 380V 4 Pôles
5023147	Motore elettrico 380V 5 Poli	Electric motor 380V 5 Poles	Elektromotor 380V 5-Polig	Motor eléctrico 380V 5 Polos	Moteur électrique 380V 5 Pôles
2131002	Campana di accoppiamento motore	Electric motor bell housings	Motor-Kupplungsglocke	Campanas de acoplamiento motor	Cloche d'accouplement moteur
5421002	Pompa doppia	Double pump	Doppelpumpe	Bomba doble	Pompe double
5444007	Interruttore con bobina	Switch with coil	Schalter mit spule	Interruptor con bobina	Interrupteur avec bobine
5444045	Condensatore motore el. 220V	220V electric motor capacitor	220V Elektromotor Kondensator	Condensadores motor el. 220V	Condensateur de mot. él. 220V
5444046	Scatola condensatore SVE-10/12	Box capacitor SVE-10/12	Box Kondensator SVE-10/12	Caja de condensadores SVE-10/12	Boîtier de condensateur SVE-10/12

SVT-10/12	TRACTOR VERTICAL LOG SPLITTER 10/12 t
SVT-10/12	STEHEND-HOLZSPALTER ZAPFWELLENANTRIEB 10/12 t
SVT-10/12	ASTILLADORA DE TRONCOS VERTICAL 10/12 t
SVT-10/12	FENDEUSE DE BÛCHES VERTICALE PDF TRACTEUR 10/12 t

Impiego: lo spaccalegna SVT-10/12 ha una spinta di 10 o 12 tonnellate e consente di spaccare tronchi di legno di dimensioni variabili, fino a 67 cm di altezza. È dotato di ruote per lo spostamento, di un ampio piano di lavoro rinforzato, di un sistema automatico di controllo finecorsa registrabile e di appositi dispositivi di sicurezza che tutelano l'utilizzatore. La linea di spaccalegna SVT è dedicata all'uso professionale. Ha una lama di grandi dimensioni e una doppia pompa che garantisce una spinta potente e velocità di lavoro.

Di serie: Scatola ingranaggi a bagno d'olio, pompa con portata 16 l/min., distributore oleodinamico con portata 40 l/min. con ritorno automatico del cassetto. **A richiesta:** Pompa con rotazione sx, cuneo a croce, cardano T-40.

Use: the SVT-10/12 log splitter has an 10 or 12 ton thrust and can split logs of various sizes, up to 67 cm in height. It is equipped with wheels for moving it, a large reinforced working table adjustable in 3 positions, an automatic adjustable "end-of-stroke control" system, and special safety devices that protect the user. The SVT log splitter line is for professional use. It has a large blade and double pump that ensures powerful thrust and operating speed.

Standard equipment: Gearbox in oil filled, pump with flow rate of 16 l/min., hydraulic distributor with flow rate of 40 l/min., with automatic piston return. **On request** Pump with left rotation, cross wedge, PTO shaft T-40.

Verwendung: der Holzspalter SVT-10/12 hat eine Schubkraft von 10 oder 12 Tonnen und kann Stämme verschiedener Größen mit einer Höhe von bis zu 67 cm spalten. Der Holzspalter ist mit Rädern zum Bewegen, einer großen verstärkten Arbeitsfläche, einer automatisch einstellbaren Endschaltersteuerung und speziellen Sicherheitsvorrichtungen zum Schutz des Benutzers ausgestattet. Die SVT-Linie ist für den professionellen Einsatz bestimmt. Sie verfügt über eine große Klinge und eine Doppelpumpe, die einen starken Schub und eine hohe Arbeitsgeschwindigkeit gewährleistet.

Serienmäßig: Getriebeöl gefüllt, Pumpe mit Förderleistung 16 l/min. und hydraulischer Verteiler mit einer Förderleistung von 40 l/min. mit automatischem Ventilrücklauf. **Auf Anfrage:** Pumpe mit Linksdrehung, Spaltkreuz und Gelenkwelle T-40.







Uso: la astilladora de troncos SVT-10/12 tiene un empuje de 10-12 toneladas y permite partir troncos de madera de dimensiones variables, hasta 67 cm de altura. Está dotada de ruedas para el desplazamiento, de un amplio plano de trabajo reforzado ajustable en 3 posiciones, de un sistema automático de "control final de carrera" ajustable y de adecuados dispositivos de seguridad que protegen al usuario. La línea de astilladoras de troncos SVT está dedicada al uso profesional. Tiene una cuchilla de grandes dimensiones y un bomba doble que garantiza un empuje potente y velocidad de trabajo.

Estándar: Caja de engranajes en baño de aceite, bomba con caudal 16 l/min, distribuidor hidráulico con caudal 40 l/min, con retorno automático de la caja. **Opcionales** Bomba con rotación izquierda, cuña en cruz, cardán T-40.

Utilisation: la fendeuse de bûches SVT-10/12 a une poussée de 10-12 tonnes et permet de fendre des troncs de bois de dimensions variables, jusqu'à 67 cm de hauteur. Elle est dotée de roues pour le déplacement, d'un large plan de travail renforcé réglable en 3 positions, d'un système automatique de "contrôle fin de course" réglable et de dispositifs de sécurité spécifiques qui protègent l'utilisateur. La ligne de fendeuses à bois SVT est dédiée à l'usage professionnel. Elle a une lame de grandes dimensions et une pompe double qui garantit poussée puissante et rapidité de travail.

De série: Boîtier engrenages à bain d'huile, pompe avec portée 16 l/min, distributeur oléodynamique avec portée 40 l/min et retour automatique du tiroir. **Sur demande:** Pompe avec rotation à gauche, coin à croix, cardan T-40.



						
mod.	cod.	ton	HP	cm	kg	cm
SVT-10/390	1002237	10	30 - 90	67	180	68×112×208
SVT-12/670	1002238	12	30 - 90	67	190	68×112×208

cod.	A richiesta	On request	Auf Anfrage	Opcionales	Sur demande
5130003	Cardano T-40	PTO shaft T-40	Gelenkwelle T-40	Cardán T-40	Cardan T-40
5421006	Pompa con rotazione sx	Pump with left rotation	Pumpe mit rotation links	Bomba con rotación izquierda	Pompe avec rotation à gauche
3350051	Cuneo a croce	Cross wedge	Spaltkreuz	Cuña en cruz.	Coin à croix

cod.	Ricambi	Spare parts	Ersatzteile	Recambios	Pièces de rechange
8350078	Coltello	Knife	Schneide	Cuchilla	Couteau
5132003	Moltiplicatore att. maschio 1"3/8	Multiplier male attachment 1"3/8	Multiplikator männl. 1"3/8	Multiplicador conexión 1"3/8	Multiplicateur attelage 1"3/8
5422004	Distributore oleodinamico	Distributor	Verteiler	Distribuidor hidráulico	Distributeur oléodynamique
5431005	Cilindro spaccalegna 390 (10 t)	Wood-splitting 390 (10 t)	Holzspaltzylinder m. 390 (10 t)	Cilindro hendidora 390 (10 t)	Cylindre pour fen. 390 (10 t)
5431008	Cilindro spaccalegna 670 (12 t)	Wood-splitting 670 (12 t)	Holzspaltzylinder m. 670 (12 t)	Cilindro hendidora 670 (12 t)	Cylindre pour fen. 670 (12 t)
5411010	Ruota	Wheel	Rad	Rueda	Roue
5421005	Pompa	Pump	Pumpe	Bomba	Pompe

16
ton

SVE-16 ECOLINE	ELECTRIC VERTICAL LOG SPLITTER 16 t
SVE-16 ECOLINE	STEHEND-HOLZSPALTER E-MOTOR 16 t
SVE-16 ECOLINE	ASTILLADORA DE TRONCOS VERTICAL 16 t
SVE-16 ECOLINE	FENDEUSE DE BÛCHES VERTICALE MOTEUR ELECTRIQUE 16 t

Impiego: lo spaccalegna SVE-16 ECO-Line ha una spinta di 16 tonnellate e consente di spaccare tronchi di legno di dimensioni variabili, fino a 67 cm di altezza. È dotato di ruote per lo spostamento, di un sistema automatico di controllo finecorsa registrabile e di appositi dispositivi di sicurezza che tutelano l'utilizzatore. La linea di spaccalegna SVE ECO-Line è dedicata all'uso professionale. È disponibile solo con cilindro da 670 mm, con piano di lavoro fisso e una doppia pompa che garantisce una spinta potente e velocità di lavoro.

Di serie: motore elettrico, pompa con valvola disgiuntiva 2+6, distributore oleodinamico con portata 40 lt/min. con ritorno automatico del cassetto, velocità rapida di accostamento tronco. **A richiesta:** cuneo a croce.

Use: the SVE-16 ECO-Line log splitter has an 16 ton thrust and can split logs of various sizes, up to 67 cm in height. It is equipped with wheels for moving it, an automatic adjustable "end-of-stroke control" system, and special safety devices that protect the user. The SVE ECO-Line log splitter line is for professional use. It is only available with 670 mm cylinder, fixed work surface, and double pump that ensures powerful thrust and operating speed.

Standard equipment: electric motor, pump with 2+6 disconnection valve, hydraulic distributor with flow rate of 40 l/min., with automatic piston return, quick speed to reach the log. **On request:** cross wedge.

Verwendung: der Holzspalter SVE-16 ECO-Line hat eine Schubkraft von 16 tonnen und kann Stämme verschiedener Größen mit einer Höhe von bis zu 67 cm spalten. Der Holzspalter ist mit Rädern zum Bewegen, einer automatisch einstellbaren Endschaltersteuerung und speziellen Sicherheitsvorrichtungen zum Schutz des Benutzers ausgestattet. Der SVE ECO-Line Holzspalter ist für den professionellen Einsatz bestimmt. Er ist nur mit 670 mm Zylinder, fester Arbeitsfläche und doppelter Pumpe erhältlich, die einen starken Schub und eine hohe Arbeitsgeschwindigkeit gewährleistet.

Serienmäßig: Elektromotor, Pumpe mit Leistungsschalterventil 2+6, hydraulischer Verteiler mit einer Fördermenge von 40 l/min, mit automatischem Kolbenrücklauf. **Auf Anfrage:** Spaltkreuz.

Uso: la astilladora de troncos SVE-16 ECO-Line tiene un empuje de 16 toneladas y permite partir troncos de madera de dimensiones variables, hasta 67 cm de altura. Está dotada de ruedas para el desplazamiento, de un sistema automático de "control final de carrera" ajustable y de adecuados dispositivos de seguridad que protegen al usuario. La línea de astilladoras de troncos SVE ECO-Line está dedicada al uso profesional. Está disponible sólo con cilindro de 670 mm, con plano de trabajo fijo y una bomba doble que garantiza un empuje potente y velocidad de trabajo.

Estándar: motor eléctrico, bomba con válvula de corte 2+6, distribuidor hidráulico de gran caudal 40 l/min, con retorno automático de la caja, velocidad rápida de acercamiento del tronco. **Opcionales** motor eléctrico trifásico de 380V, cuña en cruz.

Utilisation: la fendeuse de bûches SVE-16 ECO-Line a une poussée de 16 tonnes et permet de fendre des troncs de bois de dimensions variables, jusqu'à 67 cm de hauteur. Elle est dotée de roues pour le déplacement, d'un système automatique de "contrôle fin de course" réglable et de dispositifs de sécurité spécifiques qui protègent l'utilisateur. La ligne de fendeuses à bois SVE ECO-Line est dédiée à l'usage professionnel. Elle est disponible uniquement avec un vérin de 670 mm, avec un plan de travail fixe et une pompe double qui garantit poussée puissante et rapidité de travail.

De série: moteur électrique, pompe avec vanne de disjonction 2+6, distributeur oléodynamique de portée 40 l/min avec retour automatique du tiroir, grande vitesse d'approche des troncs. **Sur demande:** coin à croix.

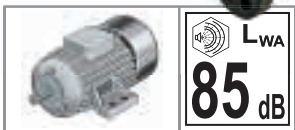

L'apparecchiatura è conforme ai requisiti richiesti dalla direttiva 2000/14/CE per la limitazione del rumore ambientale.
The equipment complies with the requirements of Directive 2000/14/EC for the limitation of environmental noise.

mod.	cod.	ton	HP	cm	kg	cm
SVE-16/670 220 V	1002437	16	3	67	195	68×112×208
SVE-16/670 380 V - 4 POLI	1003863	16	3	67	195	68×112×208
SVE-16/670 380 V - 5 POLI	1003864	16	3	67	195	68×112×208

cod.	A richiesta	On request	Auf Anfrage	Opcionales	Sur demande
3350051	Cuneo a croce	Cross wedge	Spaltkreuz	Cuña en cruz	Coin à croix

cod.	Ricambi	Spare parts	Ersatzteile	Recambios	Pièces de rechange
8350078	Coltello	Knife	Schneide	Cuchilla	Couteau
5422004	Distributore oleodinamico	Distributor	Verteiler	Distribuidor hidráulico	Distributeur oléodynamique
5411010	Ruota	Wheel	Rad	Rueda	Roue
5431024	Cilindro spaccalegna 670 (16 t)	Wood-splitting 670 (16 t)	Holzspaltzylinder m. 670 (16 t)	Cilindro hendidora 670 (16 t)	Cylindre pour fen. 670 (16 t)
5023001	Motore elettrico 220V	220V electric motor	220V Elektromotor	Motor eléctrico 220V	Moteur électrique 220V
5023039	Motore elettrico 380V 4 Poli	Electric motor 380V 4 Poles	Elektromotor 380V 4-Polig	Motor eléctrico 380V 4 Polos	Moteur électrique 380V 4 Pôles
5023147	Motore elettrico 380V 5 Poli	Electric motor 380V 5 Poles	Elektromotor 380V 5-Polig	Motor eléctrico 380V 5 Polos	Moteur électrique 380V 5 Pôles
2131002	Campana di accoppiamento motore	Electric motor bell housings	Motor-Kupplungsglocke	Campanas de acoplamiento motor	Cloche d'accouplement moteur
5421002	Pompa doppia	Double pump	Dopplepumpe	Bomba doble	Pompe double
5444007	Interruttore con bobina	Switch with coil	Schalter mit spule	Interruptor con bobina	Interrupteur avec bobine
5444045	Condensatore motore el. 220V	220V electric motor capacitor	220V Elektromotor Kondensator	Condensadores motor el. 220V	Condensateur de mot. él. 220V
5444046	Scatola condensatore SVE-16	Box capacitor SVE-16	Box Kondensator SVE-16	Caja de condensadore SVE-16	Boîtier de condensateur SVE-16

16
ton

SVT-16 ECOLINE	TRACTOR VERTICAL LOG SPLITTER 16 t
SVT-16 ECOLINE	STEHEND-HOLZSPALTER ZAPFWELLENANTRIEB 16 t
SVT-16 ECOLINE	ASTILLADORA DE TRONCOS VERTICAL 16 t
SVT-16 ECOLINE	FENDEUSE DE BÛCHES VERTICALE PDF TRACTEUR 16 t

Impiego: lo spaccalegna SVT-16 ECO-Line ha una spinta di 16 tonnellate e consente di spaccare tronchi di legno di dimensioni variabili, fino a 67 cm di altezza. È dotato di ruote per lo spostamento, di un sistema automatico di controllo finecorsa registrabile e di appositi dispositivi di sicurezza che tutelano l'utilizzatore. La linea di spaccalegna SVT ECO-Line è dedicata all'uso professionale. È disponibile solo con cilindro da 670 mm, con piano di lavoro fisso e una doppia pompa che garantisce una spinta potente e velocità di lavoro.

Di serie: Scatola ingranaggi a bagno d'olio, pompa con portata 16 l/min., distributore oleodinamico con portata 40 l/min. con ritorno automatico del cassetto.

A richiesta: pompa con rotazione sx, cuneo a croce, cardano T-40.

Use: the SVT-16 ECO-Line log splitter has an 16 ton thrust and can split logs of various sizes, up to 67 cm in height. It is equipped with wheels for moving it, an automatic adjustable "end-of-stroke control" system, and special safety devices that protect the user. The SVT ECO-Line log splitter line is for professional use. It is only available with 670 mm cylinder, fixed work surface, and double pump that ensures powerful thrust and operating speed.

Standard equipment: Gearbox in oil filled, pump with flow rate of 16 l/min., hydraulic distributor with flow rate of 40 l/min., with automatic piston return.

On request: pump with left rotation, cross wedge, PTO shaft T-40.

Verwendung: der Holzspalter SVT-16 ECO-Line hat eine Schubkraft von 16 tonnen und kann Stämme verschiedener Größen mit einer Höhe von bis zu 67 cm spalten. Der Holzspalter ist mit Rädern zum Bewegen, einer automatisch einstellbaren Endschaltersteuerung und speziellen Sicherheitsvorrichtungen zum Schutz des Benutzers ausgestattet. Der SVT ECO-Line Holzspalter ist für den professionellen Einsatz bestimmt. Er ist nur mit 670 mm Zylinder, fester Arbeitsfläche und doppelter Pumpe erhältlich, die einen starken Schub und eine hohe Arbeitsgeschwindigkeit gewährleistet.

Serienmäßig: Getriebeöl gefüllt, Pumpe mit Förderleistung 16 l/min. und hydraulischer Verteiler mit einer Förderleistung von 40 l/min. mit automatischem Ventilrücklauf.

Auf Anfrage: Pumpe mit Linksdrehung, Spaltkreuz und Gelenkwelle T-40.

Uso: la astilladora de troncos SVT-16 ECO-Line tiene un empuje de 16 toneladas y permite partir troncos de madera de dimensiones variables, hasta 67 cm de altura. Está dotada de ruedas para el desplazamiento, de un sistema automático de "control final de carrera" ajustable y de adecuados dispositivos de seguridad que protegen el usuario. La línea de astilladoras de troncos SVT ECO-Line está dedicada al uso profesional. Está disponible sólo con cilindro de 670 mm, con plano de trabajo fijo y un bomba doble que garantiza un empuje potente y velocidad de trabajo.

Estándar: Caja de engranajes en baño de aceite, bomba con caudal 16 l/min, distribuidor hidráulico con caudal 40 l/min, con retorno automático de la caja.

Opcionales: bomba con rotación izquierda, cuña en cruz, cardán T-40.

Utilisation: la fendeuse de bûches SVT-16 ECO-Line a une poussée de 16 tonnes et permet de fendre des troncs de bois de dimensions variables, jusqu'à 67 cm de hauteur. Elle est dotée de roues pour le déplacement, d'un système automatique de "contrôle fin de course" réglable et de dispositifs de sécurité spécifiques qui protègent l'utilisateur. La ligne de fendeuses à bois SVT ECO-Line est dédiée à l'usage professionnel. Elle est disponible uniquement avec un vérin de 670 mm, avec un plan de travail fixe et une pompe double qui garantit poussée puissante et rapidité de travail.

De série: Boîtier engrenages à bain d'huile, pompe avec portée 16 l/min, distributeur oléodynamique avec portée 40 l/min et retour automatique du tiroir.

Sur demande: pompe avec rotation à gauche, coin à croix, cardan T-40.



mod.	cod.	ton	HP	cm	kg	cm
SVT-16/670	1002438	16	30 - 90	67	190	68×112×208

cod.	A richiesta	On request	Auf Anfrage	Opcionales	Sur demande
5130003	Cardano T-40	PTO shaft T-40	Gelenkwelle T-40	Cardán T-40	Cardan T-40
5421010	Pompa con rotazione sx	Pump with left rotation	Pumpe mit rotation links	Bomba con rotación izquierda	Pompe avec rotation à gauche
3350051	Cuneo a croce	Cross wedge	Spaltkreuz	Cuña en cruz.	Coin à croix

cod.	Ricambi	Spare parts	Ersatzteile	Recambios	Pièces de rechange
8350078	Coltello	Knife	Schneide	Cuchilla	Couteau
5132003	Moltiplicatore att. maschio 1"3/8	Multiplier male attachment 1"3/8	Multiplikator männl. 1"3/8	Multiplicador conexión 1"3/8	Multiplicateur attelage 1"3/8
5422004	Distributore oleodinamico	Distributor	Verteiler	Distribuidor hidráulico	Distributeur oléodynamique
5431024	Cilindro spaccalegna 670 (16 t)	Wood-splitting 670 (16 t)	Holzspaltzylinder m. 670 (16 t)	Cilindro hendidora 670 (16 t)	Cylindre pour fen. 670 (16 t)
5411010	Ruota	Wheel	Rad	Rueda	Roue
5421009	Pompa	Pump	Pumpe	Bomba	Pompe



14
ton

16
ton

Impiego: lo spaccalegna SVEK-14/16 ha una spinta di 14/16 tonnellate e consente di spaccare tronchi di legno di dimensioni variabili, fino a 105 cm di altezza. È dotato di un ampio piano di lavoro rinforzato, di un sistema automatico di controllo finecorsa registrabile e di appositi dispositivi di sicurezza che tutelano l'utente. La linea di spaccalegna SVEK è dedicata all'uso professionale. Ha una lama di grandi dimensioni e una doppia pompa che garantisce una spinta potente e velocità di lavoro.

Di serie: motore elettrico, pompa con valvola disgiuntiva 2+6, distributore oleodinamico con portata 40 lt/min. con ritorno automatico del cassetto, piano di appoggio removibile e supporto laterale.

A richiesta: cuneo a croce.

Use: the SVEK-14/16 log splitter has an 14/16 ton thrust and can split logs of various sizes, up to 105 cm in height. It is equipped with a large reinforced working table adjustable in 3 positions, an automatic adjustable "end-of-stroke control" system, and special safety devices that protect the user. The SVEK log splitter line is for professional use. It has a large blade and double pump that ensures powerful thrust and operating speed. **Standard equipment:** electric motor, pump with 2+6 disconnection valve, hydraulic distributor with flow rate of 40 l/min. with automatic piston return, removable working table and side support. **On request:** cross wedge.

Verwendung: der Holzspalter SVEK-14/16 hat eine Schubkraft von 14 oder 16 tonnen und kann Stämme verschiedener Größen mit einer Höhe von bis zu 105 cm spalten und ist mit einem großen, verstärkten und in 3 Positionen verstellbaren Arbeitstisch ausgestattet. Der Holzspalter ist mit einer automatisch einstellbaren Endschaltersteuerung und speziellen Sicherheitsvorrichtungen ausgestattet, die den Benutzer schützen. Die SVEK-Linie ist für den professionellen Einsatz bestimmt. Sie verfügt über eine große Klinge und eine Doppelpumpe, die einen starken Schub und eine hohe Arbeitsgeschwindigkeit gewährleistet. **Serienmäßig:** Elektromotor, Pumpe mit Leistungsschaltventil 2+6, hydraulischer Verteiler mit einer Fördermenge von 40 l/min, mit automatischem Kolbenrücklauf, Spalttisch und Seitenstützung. **Auf Anfrage:** Spaltkreuz.

Uso: la astilladora de troncos SVEK-14/16 tiene un empuje de 14/16 toneladas y permite partir troncos de madera de dimensiones variables, hasta 105 cm de altura. Está dotada de un amplio plano de trabajo reforzado ajustable en 3 posiciones, de un sistema automático de "control final de carrera" ajustable y de adecuados dispositivos de seguridad que protegen al usuario. La línea de astilladoras de troncos SVEK está dedicada al uso profesional. Tiene una cuchilla de grandes dimensiones y una bomba doble que garantiza un empuje potente y velocidad de trabajo. **Estándar:** motor eléctrico, bomba con válvula de corte 2+6, distribuidor hidráulico de gran caudal 40 l/min. con retorno automático de la caja, plano de apoyo desmontable y soporte lateral. **Opcionales:** cuña en cruz.

Utilisation: la fendeuse de bûches SVEK-14/16 a une poussée de 14/16 tonnes et permet de fendre des troncs de bois de dimensions variables, jusqu'à 105 cm de hauteur. Elle est dotée d'un large plan de travail renforcé réglable en 3 positions, d'un système automatique de "contrôle fin de course" réglable et de dispositifs de sécurité spécifiques qui protègent l'utilisateur. La ligne de fendeuses à bois SVEK est dédiée à l'usage professionnel. Elle a une lame de grandes dimensions et une pompe double qui garantit une poussée puissante et rapidité de travail. **De série:** moteur électrique, pompe avec vanne de disjonction 2+6, distributeur oléodynamique de portée 40 l/min avec retour automatique du tiroir, plan d'appui amovible et support latéral. **Sur demande:** coin à croix.



L'apparecchiatura è conforme ai requisiti richiesti dalla direttiva 2000/14/CE per la limitazione del rumore ambientale.

The equipment complies with the requirements of Directive 2000/14/EC for the limitation of environmental noise.



SCAN ME!



mod.	cod.	ton	HP	cm	kg	cm
SVEK-14/1050 220 V	1002849	14	3 (220V)	105	325	77×114×267
SVEK-14/1050 380 V - 4 POLI	1003865	14	5,5 (380V)	105	325	77×114×267
SVEK-14/1050 380 V - 5 POLI	1003866	14	5,5 (380V)	105	325	77×114×267
SVEK-16/1050 380 V - 4 POLI	1002850	16	3 (220V)	105	335	77×114×267
SVEK-16/1050 380 V - 5 POLI	1003867	16	5,5 (380V)	105	335	77×114×267

cod.	A richiesta	On request	Auf Anfrage	Opcionales	Sur demande
3231878	Cuneo a croce	Cross wedge	Spaltkreuz	Cuña en cruz.	Coin à croix

cod.	Ricambi	Spare parts	Ersatzteile	Recambios	Pièces de rechange
3231879	Coltello	Knife	Schneide	Cuchilla	Couteau
5422004	Distrib. oleodinamico (SV14)	Distributor (SV14)	Verteiler (SV14)	Distribuidor hidráulico (SV14)	Distrib. oléodynamique (SV14)
5422012	Distrib. oleodinamico (SV16)	Distributor (SV16)	Verteiler (SV16)	Distribuidor hidráulico (SV16)	Distrib. oléodynamique (SV16)
5431011	Cilindro spaccalegna 1050 (14 t)	Wood-splitting 1050 (14 t)	Holzspaltzylinder m. 1050 (14 t)	Cilindro hendidora 1050 (14 t)	Cylindre pour fen. 1050 (14 t)
5431025	Cilindro spaccalegna 1050 (16 t)	Wood-splitting 1050 (16 t)	Holzspaltzylinder m. 1050 (16 t)	Cilindro hendidora 1050 (16 t)	Cylindre pour fen. 1050 (16 t)
5421008	Pompa doppia SVEK-14	Double pump SVEK-14	Doppelpumpe SVEK-14	Bomba doble SVEK-14	Double pompe SVEK-14
5421005	Pompa SVEK-16	Pump SVEK-16	Pumpe SVEK-16	Bomba SVEK-16	Pompe SVEK-16
5023001	Motore SVEK-14 HP 3 220V	Motor SVEK-14 HP 3 220V	Motor SVEK-14 HP 3 220V	Motor SVEK-14 HP 3 220V	Moteur SVEK-14 HP 3 220V
5023039	Motore SVEK-14 HP 5,5 380V 4 Poli	Motor SVEK-14 HP 5,5 380V 4 Poles	Motor SVEK-14 HP 5,5 380V 4-Polig	Motor SVEK-14 HP 5,5 380V 4 Polos	Moteur SVEK-14 HP 5,5 380V 4 Pôles
5023147	Motore SVEK-14 HP 5,5 380V 5 Poli	Motor SVEK-14 HP 5,5 380V 5 Poles	Motor SVEK-14 HP 5,5 380V 5-Polig	Motor SVEK-14 HP 5,5 380V 5 Polos	Moteur SVEK-14 HP 5,5 380V 5 Pôles
2131002	Campana di accopp. motore 220V	Electric motor 220V bell housings	Motor-Kupplungsglocke 220V	Campanas de acoplamiento motor 220V	Cloche d'accouplement moteur 220V
5444045	Condensatore motore el. 220V	220V electric motor capacitor	220V Elektromotor Kondensator	Condensadores motor el. 220V	Condensateur de mot. él. 220V
5444046	Scatola condensatore SVEK-14	Box capacitor SVEK-14	Box Kondensator SVEK-14	Caja de condensadore SVEK-14	Boîtier de condensateur SVEK-14
5023078	Motore SVEK-16 HP 5,5 380V 4 Poli	Motor SVEK-16 HP 5,5 380V 4 Poles	Motor SVEK-16 HP 5,5 380V 4-Polig	Motor SVEK-16 HP 5,5 380V 4 Polos	Moteur SVEK-16 HP 5,5 380V 4 Pôles
5023149	Motore SVEK-16 HP 5,5 380V 5 Poli	Motor SVEK-16 HP 5,5 380V 5 Poles	Motor SVEK-16 HP 5,5 380V 5-Polig	Motor SVEK-16 HP 5,5 380V 5 Polos	Moteur SVEK-16 HP 5,5 380V 5 Pôles
2131010	Campana di accopp. motore 380V	Electric motor 380V bell housings	Motor-Kupplungsglocke 380V	Campanas de acoplamiento motor 380V	Cloche d'accouplement moteur 380V
3231877	Piano di appoggio removibile	Removable working table	Spalttisch	Plano de apoyo desmontable	Plan d'appui amovible
3230298	Supporto laterale piano di appoggio	Side support for working table	Seitenstützung für Arbeitstisch	Soporte laterale plano de apoyo	Support latéral plan d'appui



SVTK-14/16	TRACTOR VERTICAL LOG SPLITTER 14/16 t
SVTK-14/16	STEHEND-HOLZSPALTER ZAPFWELLENANTRIEB 14/16 t
SVTK-14/16	ASTILLADORA DE TRONCOS VERTICAL 14/16 t
SVTK-14/16	FENDEUSE DE BÛCHES VERTICALE PDF TRACTEUR 14/16 t

Impiego: lo spaccalegna SVTK-14/16 ha una spinta di 14/16 tonnellate e consente di spaccare tronchi di legno di dimensioni variabili, fino a 105 cm di altezza. È dotato, di un ampio piano di lavoro rinforzato, di un sistema automatico di controllo finecorsa registrabile e di appositi dispositivi di sicurezza che tutelano l'utilizzatore. La linea di spaccalegna SVTK è dedicata all'uso professionale. Ha una lama di grandi dimensioni e una doppia pompa che garantisce una spinta potente e velocità di lavoro.

Di serie: Scatola ingranaggi a bagno d'olio, pompa con portata 16 l/min., distributore oleodinamico con portata 40 l/min. con ritorno automatico del cassetto, piano di appoggio removibile e supporto laterale.

A richiesta: cuneo a croce, cardano T-40.

Use: the SVTK-14/16 log splitter has an 14/16 ton thrust and can split logs of various sizes, up to 105 cm in height. It is equipped with a large reinforced working table adjustable in 3 positions, an automatic adjustable "end-of-stroke control" system, and special safety devices that protect the user. The SVTK log splitter line is for professional use. It has a large blade and double pump that ensures powerful thrust and operating speed.

Standard equipment: Gearbox in oil filled, pump with flow rate of 16 l/min., hydraulic distributor with flow rate of 40 l/min., with automatic piston return, removable working table and side support.

On request: cross wedge, PTO shaft T-40.

Verwendung: der Holzspalter SVTK-14/16 hat eine Schubkraft von 14 oder 16 tonnen und kann Stämme verschiedener Größen mit einer Höhe von bis zu 105 cm spalten und ist mit einem großen, verstärkten und in 3 Positionen verstellbaren Arbeitstisch ausgestattet. Der Holzspalter ist mit einer automatisch einstellbaren Endschaltesteuerung und speziellen Sicherheitsvorrichtungen ausgestattet, die den Benutzer schützen. Die SVTK-Linie ist für den professionellen Einsatz bestimmt. Sie verfügt über eine große Klinge und eine Doppelpumpe, die einen starken Schub und eine hohe Arbeitsgeschwindigkeit gewährleistet.

Serienmäßig: Getriebeöl gefüllt, Pumpe mit Förderleistung 16 l/min. und hydraulischer Verteiler mit einer Förderleistung von 40 l/min. mit automatischem Ventilrücklauf, Spalttisch und Seitenstützung.

Auf Anfrage: Spaltkreuz und Gelenkwelle T-40.

Usò: la astilladora de troncos SVTK-14/14 tiene un empuje de 14/16 toneladas y permite partir troncos de madera de dimensiones variables, hasta 105 cm de altura. Está dotada de un amplio plano de trabajo reforzado ajustable en 3 posiciones, de un sistema automático de "control final de carrera" ajustable y de adecuados dispositivos de seguridad que protegen al usuario. La línea de astilladoras de troncos SVTK está dedicada al uso profesional. Tiene una cuchilla de grandes dimensiones y un bomba doble que garantiza un empuje potente y velocidad de trabajo.







Estándar: Caja de engranajes en baño de aceite, bomba con caudal 16 l/min, distribuidor hidráulico con caudal 40 l/min, con retorno automático de la caja, plano de apoyo desmontable y soporte lateral.

Opcionales: cuña en cruz, cardán T-40.

Utilisation: la fendeuse de bûches SVTK-14/16 a une poussée de 14/16 tonnes et permet de fendre des troncs de bois de dimensions variables, jusqu'à 105 cm de hauteur. Elle est dotée d'un large plan de travail renforcé réglable en 3 positions, d'un système automatique de "contrôle fin de course" réglable et de dispositifs de sécurité spécifiques qui protègent l'utilisateur. La ligne de fendeuses à bois SVTK est dédiée à l'usage professionnel. Elle a une lame de grandes dimensions et une double pompe qui garantit poussée puissante et rapidité de travail.

De série: Boîtier engrenages à bain d'huile, pompe avec portée 16 l/min, distributeur oléodynamique avec portée 40 l/min. et retour automatique du tiroir, plan d'appui amovible et support latéral. **Sur demande:** coin à croix, cardan T-40.

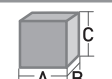

 SCAN ME!							
							mod.

cod.	A richiesta	On request	Auf Anfrage	Opcionales	Sur demande
5130003	Cardano T-40	PTO shaft T-40	Gelenkwelle T-40	Cardán T-40	Cardan T-40
3231878	Cuneo a croce	Cross wedge	Spaltkreuz	Cuña en cruz	Coin à croix

cod.	Ricambi	Spare parts	Ersatzteile	Recambios	Pièces de rechange
3231879	Coltello	Knife	Schneide	Cuchilla	Couteau
5132003	Moltiplicatore att. maschio 1"3/8	Multiplier male attachment 1"3/8	Multiplikator männl. 1"3/8	Multiplicador conexión 1"3/8	Multiplificateur attelage 1"3/8
5422004	Distrib. oleodinamico (SV14)	Distributor (SV14)	Verteiler (SV14)	Distribuidor hidráulico (SV14)	Distrib. oléodynamique (SV14)
5422012	Distrib. oleodinamico (SV16)	Distributor (SV16)	Verteiler (SV16)	Distribuidor hidráulico (SV16)	Distrib. oléodynamique (SV16)
5431011	Cilindro spaccalegna 1050 (14 t)	Wood-splitting 1050 (14 t)	Holzspaltzylinder m. 1050 (14 t)	Cilindro hendidora 1050 (14 t)	Cylindre pour fen. 1050 (14 t)
5431025	Cilindro spaccalegna 1050 (W16 t)	Wood-splitting 1050 (16 t)	Holzspaltzylinder m. 1050 (16 t)	Cilindro hendidora 1050 (16 t)	Cylindre pour fen. 1050 (16 t)
5421005	Pompa SVTK 14	Pump SVTK 14	Pumpe SVTK 14	Bomba SVTK 14	Pompe SVTK 14
5421009	Pompa SVTK 16	Pump SVTK 16	Pumpe SVTK 16	Bomba SVTK 16	Pompe SVTK 16
3231877	Piano di appoggio removibile	Removable working table	Spalttisch	Plano de apoyo desmontable	Plan d'appui amovible
3230298	Supporto laterale piano di appoggio	Side support for working table	Seitenstützung für Arbeitstisch	Soporte lateral plano de apoyo	Support latéral plan d'appui

20
ton

SVE-20	ELECTRIC VERTICAL LOG SPLITTER 20 t
SVE-20	STEHEND-HOLZSPALTER E-MOTOR 20 t
SVE-20	ASTILLADORA DE TRONCOS VERTICAL 20 t
SVE-20	FENDEUSE DE BÛCHES VERTICALE MOTEUR ELECTRIQUE 20 t

Impiego: lo spaccalegna SVE-20 ha una spinta di 20 tonnellate e consente di spaccare tronchi di legno di dimensioni variabili, fino a 110 cm di altezza. La linea SVE-Pesante è dedicata all'uso professionale ed è fornita Di serie: con cilindro da 1050 mm. È dotato di un sistema automatico di controllo finecorsa registrabile e di appositi dispositivi di sicurezza che tutelano l'utilizzatore.

Di serie: motore elettrico trifase 380V 8,5 HP, pompa con notevole portata, distributore oleodinamico con portata 40 lt/min. con ritorno automatico del cassetto, velocità rapida di accostamento coltello, carico meccanico del tronco, piano di appoggio removibile e supporto laterale. **A richiesta:** cuneo a croce.

Use: the SVE-20 log splitter has an 20 ton thrust and can split logs of various sizes, up to 110 cm in height. The SVE-Heavy line is for professional use and comes with a 1050 mm cylinder. It is equipped with automatic adjustable "end-of-stroke control" system, and special safety devices that protect the user.

Standard equipment: 380V three-phase electric motor 8,5 HP, pump with considerable flow rate, hydraulic distributor with flow rate of 40 l/min. with automatic valve return, quick speed to reach the log, mechanical side wood-loader, removable working table and side support. **On request:** cross wedge.

Verwendung: der Holzspalter SVE-20 hat eine Schubkraft von 20 tonnen und kann Stämme verschiedener Größen mit einer Höhe von bis zu 110 cm spalten. Die SVE-Schwerlinie ist für den professionellen Einsatz bestimmt und wird mit einem 1050-mm-Zylinder. Der Holzspalter ist mit einer automatisch einstellbaren Endschaltersteuerung und speziellen Sicherheitsvorrichtungen ausgestattet, die den Benutzer schützen.

Serienmäßig: Dreiphasen-Elektromotor 380V 8,5 HP, Pumpe mit beachtlicher Förderleistung, hydraulischer Verteiler mit einer Förderleistung von 40 l/min. mit automatischer Kolbenrücklauf, Schnelle Messer-Anfahrsgeschwindigkeit, Mechanischer Stammheber, Spalttisch und Seitenstützung. **Auf Anfrage:** Spaltkreuz.

Usò: la astilladora de troncos SVE-20 tiene un empuje de 20 toneladas y permite partir troncos de madera de dimensiones variables, hasta 110 cm de altura. La línea SVE-Pesada está dedicada al uso profesional y se suministra con cilindro de 1050 mm. Está dotada de un sistema automático de "control final de carrera" ajustable y de adecuados dispositivos de seguridad que protegen el usuario.

Estándar: motor eléctrico trifásico de 380V 8,5 HP, bomba de gran caudal, distribuidor hidráulico con caudal 40 l/min, con retorno automático de la caja, velocidad rápida de acercamiento de la cuchilla, cargador mecánico del tronco, plano de apoyo desmontable y soporte lateral. **Opcionales:** cuña en cruz.

Utilisation: la fendeuse de bûches SVE-20 a une poussée de 20 tonnes et permet de fendre des troncs de bois de dimensions variables, jusqu'à 110 cm de hauteur. La ligne SVE-Pesante est dédiée à l'usage professionnel et est équipée de série d'un vérin de 1050 mm. Elle est dotée d'un système automatique de "contrôle fin de course" réglable et de dispositifs de sécurité spécifiques qui protègent l'utilisateur.

De série: moteur électrique triphasé 380V 8,5 HP, pompe de portée considérable, distributeur oléodynamique de portée 40 l/min avec retour automatique du tiroir, vitesse d'approche rapide de couteau, chargement mécanique des troncs, plan d'appui amovible et support latéral. **Sur demande:** coin à croix.



L'apparecchiatura è conforme ai requisiti richiesti dalla direttiva 2000/14/CE per la limitazione del rumore ambientale.
The equipment complies with the requirements of Directive 2000/14/EC for the limitation of environmental noise.

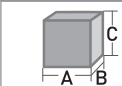

mod.	cod.	ton	HP	cm	kg	cm
SVE-20/1050 380 V - 4 POLI	1002414	20	8,5 (380V)	110	370	87×120×260
SVE-20/1050 380 V - 5 POLI	1003868	20	8,5 (380V)	110	370	87×120×260

cod.	A richiesta	On request	Auf Anfrage	Opcionales	Sur demande
3230748	Cuneo a croce	Cross wedge	Spaltkreuz	Cuña en cruz.	Coin à croix

cod.	Ricambi	Spare parts	Ersatzteile	Recambios	Pièces de rechange
5431013	Cilindro spaccalegna 1050 (20 t)	Wood-splitting 1050 (20 t)	Holzspaltzylinder m. 1050 (20 t)	Cilindro hendidora 1050 (20 t)	Cylindre pour fen. 1050 (20 t)
5023092	Motore elettrico 8,5 HP 380V 4 Poli	Electric motor 8,5 HP 380V 4 Poles	Elektromotor 8,5 HP 380V 4-Polig	Motor eléctrico 8,5 HP 380V 4 Polos	Moteur électrique 8,5 HP 380V 4 Pôles
5023148	Motore elettrico 8,5 HP 380V 5 Poli	Electric motor 8,5 HP 380V 5 Poles	Elektromotor 8,5 HP 380V 5-Polig	Motor eléctrico 8,5 HP 380V 5 Polos	Moteur électrique 8,5 HP 380V 5 Pôles
2131006	Campana di accoppiamento motore	Electric motor bell housings	Motor-Kupplungsglocke	Campanas de acoplamiento motor	Cloche d'accouplement moteur
5421005	Pompa	Pump	Pumpe	Bomba	Pompe
3230156	Piano di appoggio removibile	Removable working table	Spalttisch	Plano de apoyo desmontable	Plan d'appui amovible
3230298	Supporto laterale piano di appoggio	Side support for working table	Seitenstützung für Arbeitstisch	Soporte lateral plano de apoyo	Support latéral plan d'appui



SVT-20	TRACTOR VERTICAL LOG SPLITTER 20 t
SVT-20	STEHEND-HOLZSPALTER ZAPFWELLENANTRIEB 20 t
SVT-20	ASTILLADORA DE TRONCOS VERTICAL 20 t
SVT-20	FENDEUSE DE BÛCHES VERTICALE PDF TRACTEUR 20 t

Impiego: lo spaccalegna SVT-20 ha una spinta di 20 tonnellate e consente di spaccare tronchi di legno di dimensioni variabili, fino a 110 cm di altezza. La linea SVT-Pesante è dedicata all'uso professionale ed è fornita di serie con cilindro da 1050 mm. È dotato di un sistema automatico di controllo finecorsa registrabile e di appositi dispositivi di sicurezza che tutelano l'utilizzatore.

Di serie: scatola ingranaggi bagno d'olio, pompa di notevole portata, distributore oleodinamico con portata 40 lt/min. con ritorno automatico del cassetto, velocità rapida di accostamento coltello, carico meccanico del tronco, piano di appoggio removibile e supporto laterale.

A richiesta: cuneo a croce, cardano T-50.

Use: the SVT-20 log splitter has an 20 ton thrust and can split logs of various sizes, up to 110 cm in height. The SVT-Heavy line is for professional use and comes with a 1050 mm cylinder. It is equipped with automatic adjustable "end-ofstroke control" system, and special safety devices that protect the user.

Standard equipment: Gearbox oil filled, pump with considerable flow rate, hydraulic distributor with flow rate of 40 l/min. with automatic valve return, quick speed to reach the log, mechanical side wood-loader, removable working table and side support.

On request: cross wedge, PTO shaft T-50.

Verwendung: der Holzspalter SVT-20 hat eine Schubkraft von 20 tonnen und kann Stämme verschiedener Größen mit einer Höhe von bis zu 110 cm spalten. Die SVT-Schwerlinie ist für den professionellen Einsatz bestimmt und wird mit einem 1050-mm-Zylinder. Der Holzspalter ist mit einer automatisch einstellbaren Endschaltersteuerung und speziellen Sicherheitsvorrichtungen ausgestattet, die den Benutzer schützen.

Serienmäßig: Getriebeöl gefüllt, Pumpe mit beachtlicher Förderleistung, hydraulischer Verteiler mit einer Förderleistung von 40 l/min. mit automatischem Ventilrücklauf, Schnelle Messer-Anfahrsgeschwindigkeit, Mechanischer Stammheber, Spalttisch und Seitenstützung.

Auf Anfrage: Spaltkreuz und Gelenkwelle T-50.

Uso: la astilladora de troncos SVT-20 tiene un empuje de 20 toneladas y permite partir troncos de madera de dimensiones variables, hasta 110 cm de altura. La línea SVT-Pesada está dedicada al uso profesional y se suministra con cilindro de 1050 mm. Está dotada de un sistema automático de "control final de carrera" ajustable y de adecuados dispositivos de seguridad que protegen el usuario.

Estándar: caja de engranajes en baño de aceite, bomba de gran caudal, distribuidor hidráulico con caudal 40 l/min, con retorno automático de la caja, velocidad rápida de acercamiento de la cuchilla, cargador mecánico del tronco, plano de apoyo desmontable y soporte laterale.







Opcionales: cuña en cruz, cardán T-50.

Utilisation: la fendeuse de bûches SVT-20 a une poussée de 20 tonnes et permet de fendre des troncs de bois de dimensions variables, jusqu'à 110 cm de hauteur. La ligne SVT-Pesante est dédiée à l'usage professionnel et est équipée de série d'un vérin de 1050 mm. Elle est dotée d'un système automatique de "contrôle fin de course" réglable et de dispositifs de sécurité spécifiques qui protègent l'utilisateur.

De série: boîtier d'engrenages à bain d'huile, pompe de grande portée, distributeur oléodynamique de portée 40 l/min avec retour automatique du tiroir, vitesse d'approche rapide de couteau, chargement mécanique des troncs, plan d'appui amovible et support latéral.

Sur demande: coin à croix, cardan T-50.



						
mod.	cod.	ton	HP	cm	kg	cm
SVT-20/1050	1002413	20	30 - 90	110	365	87×120×260

cod.	A richiesta	On request	Auf Anfrage	Opcionales	Sur demande
5130005	Cardano T-50	PTO shaft T-50	Gelenkwelle T-50	Cardán T-50	Cardan T-50
3230748	Cuneo a croce	Cross wedge	Spaltkreuz	Cuña en cruz	Coin à croix

cod.	Ricambi	Spare parts	Ersatzteile	Recambios	Pièces de rechange
5431013	Cilindro spaccalegna 1050 (20 t)	Wood-splitting 1050 (20 t)	Holzspaltzylinder m. 1050 (20 t)	Cilindro hendidora 1050 (20 t)	Cylindre pour fen. 1050 (20 t)
5421009	Pompa destra	Pump right	Pumpe recht	Bomba dcha	Pompe droite
3230156	Piano di appoggio removibile	Removable working table	Spalttisch	Plano de apoyo desmontable	Plan d'appui amovible
3230298	Supporto laterale piano di appoggio	Side support for working table	Seitenstützung für Arbeitstisch	Soporte laterale plano de apoyo	Support latéral plan d'appui



SVI-20	HYDRAULIC VERTICAL LOG SPLITTER 20 t
SVI-20	STEHEND-HOLZSPALTER HYDRAULISCH 20 t
SVI-20	ASTILLADORA DE TRONCOS VERTICAL 20 t
SVI-20	FENDEUSE DE BÛCHES VERTICALE HYDRAULIQUE 20 t

Impiego: lo spaccalegna SVI-20 ha una spinta di 20 tonnellate e consente di spaccare tronchi di legno di dimensioni variabili, fino a 110 cm di altezza. La linea SVI-Pesante è dedicata all'uso professionale ed è fornita di serie con cilindro da 1050 mm. È dotato di un sistema automatico di controllo finecorsa registrabile e di appositi dispositivi di sicurezza che tutelano l'utilizzatore.

Di serie: Scatola ingranaggi bagno d'olio, pompa di notevole portata, distributore oleodinamico con portata 40 lt/min. con ritorno automatico del cassetto velocità rapida di accostamento coltello, carico meccanico del tronco, piano di appoggio removibile e supporto laterale.

A richiesta: cuneo a croce.

Use: the SVI-20 log splitter has an 20 ton thrust and can split logs of various sizes, up to 110 cm in height. The SVI-Heavy line is for professional use and comes with a 1050 mm. It is equipped with automatic adjustable "end-of-stroke control" system, and special safety devices that protect the user.

Standard equipment: Gearbox oil filled, pump with considerable flow rate, hydraulic distributor with flow rate of 40 l/min. with automatic valve return, quick speed to reach the log, mechanical side wood-loader, removable working table and side support.

On request: cross wedge.

Verwendung: der Holzspalter SVI-20 hat eine Schubkraft von 20 tonnen und kann Stämme verschiedener Größen mit einer Höhe von bis zu 110 cm spalten. Die SVI-Schwerlinie ist für den professionellen Einsatz bestimmt und wird mit einem 1050-mm-Zylindert. Der Holzspalter ist mit einer automatisch einstellbaren Endschaltersteuerung und speziellen Sicherheitsvorrichtungen ausgestattet, die den Benutzer schützen.

Serienmäßig: Getriebeöl gefüllt, Pumpe mit beachtlicher Förderleistung, hydraulischer Verteiler mit einer Förderleistung von 40 l/min. mit automatischer Kolbenrücklauf, Schnelle Messer-Anfahrsgeschwindigkeit, Mechanischer Stammheber, Spalttisch und Seitenstützung.

Auf Anfrage: Spaltkreuz.

Uso: la astilladora de troncos SVI-20 tiene un empuje de 20 toneladas y permite partir troncos de madera de dimensiones variables, hasta 110 cm de altura. La línea SVI-Pesada está dedicada al uso profesional y se suministra con cilindro de 1050 mm. Está dotada de un sistema automático de "control final de carrera" ajustable y de adecuados dispositivos de seguridad que protegen el usuario.

Estándar: caja de engranajes en baño de aceite, bomba de gran caudal, distribuidor hidráulico con caudal 40 l/min, con retorno automático de la caja, velocidad rápida de acercamiento de la cuchilla, cargador mecánico del tronco, plano de apoyo desmontable y soporte lateral.







Opcionales: cuña en cruz.

Utilisation: la fendeuse de bûches SVI-20 a une poussée de 20 tonnes et permet de fendre des troncs de bois de dimensions variables, jusqu'à 110 cm de hauteur. La ligne SVI-Pesante est dédiée à l'usage professionnel et est équipée de série d'un vérin de 1050 mm. Elle est dotée d'un système automatique de "contrôle fin de course" réglable et de dispositifs de sécurité spécifiques qui protègent l'utilisateur.

De série: boîtier d'engrenages à bain d'huile, pompe de grande portée, distributeur oléodynamique de portée 40 l/min avec retour automatique du tiroir, vitesse d'approche rapide de couteau, chargement mécanique des troncs, plan d'appui amovible et support latéral.

Sur demande: coin à croix.



						
mod.	cod.	ton	HP	cm	kg	cm
SVI-20/1050	1002415	20	--	110	325	87×120×260

cod.	A richiesta	On request	Auf Anfrage	Opcionales	Sur demande
3230748	Cuneo a croce	Cross wedge	Spaltkreuz	Cuña en cruz.	Coin à croix

cod.	Ricambi	Spare parts	Ersatzteile	Recambios	Pièces de rechange
5431013	Cilindro spaccalegna 1050 (20 t)	Wood-splitting 1050 (20 t)	Holzspaltzylinder m. 1050 (20 t)	Cilindro hendidora 1050 (20 t)	Cylindre pour fen. 1050 (20 t)
5422012	Distributore oleodinamico	Distributor	Verteiler	Distribuidor hidráulico	Distributeur oléodynamique
3230156	Piano di appoggio removibile	Removable working table	Spalttisch	Plano de apoyo desmontable	Plan d'appui amovible
3230298	Supporto laterale piano di appoggio	Side support for working table	Seitenstützung für Arbeitstisch	Soporte lateral plano de apoyo	Support latéral plan d'appui

25
ton



cod. 3230748
On request
Cuneo a croce
Cross wedge
Spaltkreuz
Cuña en cruz
Coin à croix



cod. 3230156 - cod. 3230298
On request

Piano di appoggio removibile e supporto laterale
Removable working table and side support
Spalttisch und Seitenstützung.
Plano de apoyo desmontable y soporte lateral.
plan d'appui amovible et support latéral

SVT-25



**SCAN
ME!**



mod.	cod.	ton	HP	cm	kg	cm
SVT-25	1002548	25	40 - 100	110	650	125×140×260

SVT-25	TRACTOR VERTICAL LOG SPLITTER 25 t
SVT-25	STEHEND-HOLZSPALTER ZAPFWELLENANTRIEB 25 t
SVT-25	ASTILLADORA DE TRONCOS VERTICAL 25 t
SVT-25	FENDEUSE DE BÛCHES VERTICALE PDF TRACTEUR 25 t



Standard equipment

Kit caricamento tronco meccanico
Mechanical side wood-loader
Mechanischer Stammheber
Cargador mecanico del tronco
Kit de chargement mécanique des troncs

Impiego: lo spaccalegna SVT-25 ha una spinta di 25 tonnellate e consente di spaccare tronchi di legno di dimensioni variabili, fino a 110 cm di altezza. La linea SVT-Pesante è dedicata all'uso professionale ed è fornita di serie con cilindro da 1050 mm. È dotato di un sistema automatico di controllo finecorsa registrabile e di appositi dispositivi di sicurezza che tutelano l'utilizzatore.

Di serie: scatola ingranaggi bagno d'olio, pompa di notevole portata, distributore oleodinamico con portata 80 lt/min. con ritorno automatico del cassetto, velocità rapida di accostamento coltello, carico meccanico del tronco.

A richiesta: cuneo a croce, cardano T-50, piano di appoggio removibile e supporto laterale.

Use: the SVT-25 log splitter has an 25 ton thrust and can split logs of various sizes, up to 110 cm in height. The SVT-Heavy line is for professional use and comes with a 1050 mm cylinder. It is equipped with automatic adjustable "end-ofstroke control" system, and special safety devices that protect the user.

Standard equipment: gearbox oil filled, pump with considerable flow rate, hydraulic distributor with flow rate of 80 l/min. with automatic valve return, quick speed to reach the log, mechanical side wood-loader.

On request: cross wedge, PTO shaft T-50, removable working table and side support.

Verwendung: der Holzspalter SVT-25 hat eine Schubkraft von 25 Tonnen und kann Stämme verschiedener Größen mit einer Höhe von bis zu 110 cm spalten. Die SVT-Schwerlinie ist für den professionellen Einsatz bestimmt und wird mit einem 1050-mm-Zylinder. Der Holzspalter ist mit einer automatisch einstellbaren Endschaltesteuerung und speziellen Sicherheitsvorrichtungen ausgestattet, die den Benutzer schützen.

Serienmäßig: Getriebeöl gefüllt, Pumpe mit beachtlicher Förderleistung, hydraulischer Verteiler mit einer Förderleistung von 80 l/min. mit automatischer Ventilrücklauf, Schnelle Messer-Anfahrsgeschwindigkeit, Mechanischer Stammheber.

Auf Anfrage: Spaltkreuz und Gelenkwelle T-50, Spalttisch und Seitenstützung.

Uso: la astilladora de troncos SVT-25 tiene un empuje de 25 toneladas y permite partir troncos de madera de dimensiones variables, hasta 110 cm de altura. La línea SVT-Pesada está dedicada al uso profesional y se suministra con cilindro de 1050 mm. Está dotada de un sistema automático de "control final de carrera" ajustable y de adecuados dispositivos de seguridad que protegen al usuario.

Estándar: caja de engranajes en baño de aceite, bomba de gran caudal, distribuidor hidráulico con caudal 80 l/min, con retorno automático de la caja, velocidad rápida de acercamiento de la cuchilla, cargador mecánico del tronco.

Opcionales: cuña en cruz, cardán T-50, plano de apoyo desmontable y soporte lateral.

Utilisation: la fendeuse de bûches SVT-25 a une poussée de 25 tonnes et permet de fendre des troncs de bois de dimensions variables, jusqu'à 110 cm de hauteur. La ligne SVT-Pesante est dédiée à l'usage professionnel et est équipée de série d'un vérin de 1050 mm. Elle est dotée d'un système automatique de "contrôle fin de course" réglable et de dispositifs de sécurité spécifiques qui protègent l'utilisateur.

De série: boîtier d'engrenages à bain d'huile, pompe de grande portée, distributeur oléodynamique de portée 80 l/min avec retour automatique du tiroir, vitesse d'approche rapide de couteau, chargement mécanique des troncs.

Sur demande: coin à croix, cardan T-50, plan d'appui amovible et support latéral.

cod.	A richiesta	On request	Auf Anfrage	Opcionales	Sur demande
5130005	Cardano T-50	PTO shaft T-50	Gelenkwelle T-50	Cardán T-50	Cardan T-50
3230748	Cuneo a croce	Cross wedge	Spaltkreuz	Cuña en cruz	Coin à croix
3230156	Piano di appoggio removibile	Removable working table	Spalttisch	Plano de apoyo desmontable	Plan d'appui amovible
3230298	Supporto laterale piano di appoggio	Side support for working table	Seitenstützung für Arbeitstisch	Soporte laterale plano de apoyo	Support latéral plan d'appui

cod.	Ricambi	Spare parts	Ersatzteile	Recambios	Pièces de rechange
5132004	Moltiplicatore att. maschio 1"3/8	Multiplier male attachment 1"3/8	Multiplikator männl. 1"3/8	Multiplicador conexión 1"3/8	Multiplicateur attelage 1"3/8
5421018	Pompa gruppo 3 C51 dx	Pump unit 3 C51 right	Pumpe aggregat 3 C51 recht	Grupo bomba 3 C51 dcha	Pompe groupe 3 C51 droite
5431041	Cilindro 25-1050	Cylinder 25-1050	Zylinder 25-1050	Cilindro 25-1050	Cylindre 25-1050





1964
2024
60
ANNIVERSARY

BIOTRITURATORI e MINI-DUMPERS
WOOD CHIPPER and MINI-DUMPERS
HOLZHÄCKSLER und MINI-RAUPENDUMPER
BIOTRITURADORAS y MINI-DUMPERS
BROYEURS DE VÉGÉTAUX et MINI-TOMBEREAUX

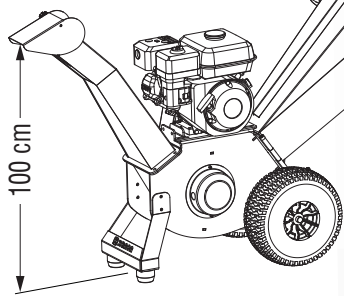

COMBUSTION ENGINE BIO-SHREDDER
HOLZHÄCKSLER MIT VERBRENNUNGSMOTOR
BIOTRITURADORA CON MOTOR DE GASOLINA
BIO-BROYEUR À MOTEUR À COMBUSTION



POWERED by
LONCIN



L'apparecchiatura è conforme ai requisiti richiesti dalla direttiva 2000/14/CE per la limitazione del rumore ambientale.

The equipment complies with the requirements of Directive 2000/14/EC for the limitation of environmental noise.



SCAN ME!



mod.	cod.	HP	kg	cm
CIP 100-S	1004006	LONCIN 212 cc - 7 HP	99	52×178×118

MOD	cm	rpm/min	nr	nr
CIP 100-S	7,5	2800	2	1

Di serie

- Motore a scoppio con avviamento manuale
- Sistema di taglio professionale con lame in acciaio di altissima qualità
- Ruote 13×5.00/6" tubeless
- Controlama a 2 taglienti riposizionabili
- Trasmissione a cinghia trapezoidale
- Protezioni antinfortunistiche conformi alla normativa CE

Standard equipment

- Combustion engine with manual start
- Professional cutting system with high quality steel blades
- 13×5.00/6" tubeless wheels
- Counter-blades with 2 repositionable cutting edges
- V-belt drive
- Protective equipment as per EC safety rules

Serienmässig

- Verbrennungsmotor mit Handstart
- Professionelles Schneidsystem mit hochwertigen Stahlmessern
- 13×5.00/6" schlauchlose Räder
- Gegenmesser mit 2 verstellbaren Schneidkanten
- Keilriemenantrieb
- Unfallschutz nach EU-Vorschriften

De serie

- Motor de gasolina con arranque manual
- Sistema de corte profesional con cuchillas de acero de alta calidad
- Ruedas sin cámara 13×5.00/6"
- Contracuchillas reposicionables de 2 filos
- Transmisión por correa trapezoidal
- Protecciones de seguridad de acuerdo con la norma CE

De série

- Moteur à combustion avec démarrage manuel
- Système de coupe professionnel avec des lames en acier de très haute qualité
- Roues sans chambre à air 13×5.00/6"
- Contre-lames à 2 tranchants repositionnables
- Entraînement par courroie trapézoïdale
- Protections contre les accidents conformes aux normes CE

cod.	Ricambi	Spare parts	Ersatzteile	Recambios	Pièces de rechange
5023154	Motore LONCIN HP 7	LONCIN HP 7 motor	Motor LONCIN HP 7	Motor LONCIN HP 7	Moteur LONCIN HP 7
5350302	Controlama	Counterblade	Gegenschlägel	Contracuchilla	Contre-lames
5353288	Frizione	Clutch	Kupplung	Fricción	Embrayage
5354101	Cinghia XPA900	Cug belt XPA900	Keilriemen XPA900	Correa XPA900	Courroie XPA900



60 1964
2024
ANNIVERSARY



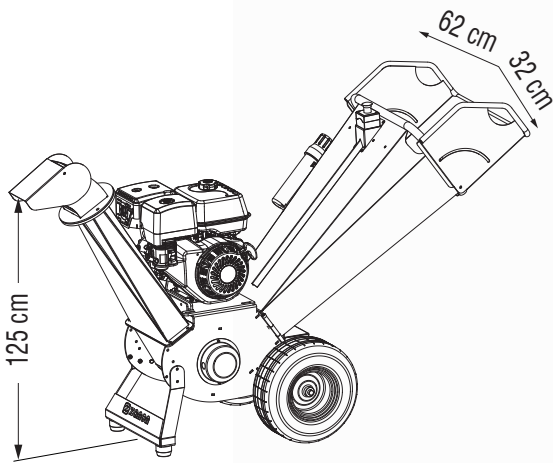









POWERED by
LONCIN

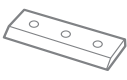

L'apparecchiatura è conforme ai requisiti richiesti dalla direttiva 2000/14/CE per la limitazione del rumore ambientale.

The equipment complies with the requirements of Directive 2000/14/EC for the limitation of environmental noise.

					
mod.	cod.	HP	kg	cm	
CIP 120-S	1004007	LONCIN 420 cc 13 HP	205	75×202×150	
CIP 120-S Avv. elettrico	1004008	LONCIN 420 cc 14 HP	205	75×202×150	
MOD					
mod.	cm	rpm/min	nr	nr	
CIP 120-S	10	2800	2	1	
CIP 120-S Avv. elettrico	10	2800	2	1	

Di serie

- Motore a scoppio con avviamento manuale o con avviamento elettrico
- Sistema di taglio professionale con lame in acciaio di altissima qualità
- Ruote 16×6,5/8" tubeless
- Scarico orientabile a 360°
- Controlame a 2 taglienti riposizionabili
- Trasmissione a doppia cinghia trapezoidale
- Protezioni antinfortunistiche conformi alla normativa CE

Standard equipment

- Combustion engine with manual or electric start
- Professional cutting system with high-quality steel blades
- 16×6,5/8" tubeless wheels
- 360° adjustable discharge
- Counter-blades with 2 repositionable cutting edges
- Double V-belt drive
- Protective equipment as per EC safety rules

Serienmässig

- Verbrennungsmotor mit Handstart oder Elektrostart
- Professionelles Schneidsystem mit hochwertigen Stahlmessern
- Schlauchlose Räder 16×6,5/8"
- 360° schwenkbarer Auswurf
- Gegenmesser mit 2 verstellbaren Schneidkanten
- Doppelter Keilriemenantrieb
- Unfallschutz nach EU-Vorschriften

De serie

- Motor de gasolina con arranque manual o eléctrico
- Sistema de corte profesional con cuchillas de acero de alta calidad
- Ruedas sin cámara 16×6,5/8"
- Escape orientable 360°
- Contracuchillas con 2 fillos reposicionables
- Doble transmisión por correa trapezoidal
- Protecciones de seguridad de acuerdo con la norma CE

De série

- Moteur à combustion avec démarrage manuel ou électrique
- Système de coupe professionnel avec des lames en acier de très haute qualité
- Roues sans chambre à air 16×6,5/8"
- Décharge orientable à 360°
- Contre-lames à 2 tranchants repositionnables
- Entraînement par double courroie trapézoïdale
- Protections contre les accidents conformes aux normes CE

CIP 120-S

COMBUSTION ENGINE BIO-SHREDDER

CIP 120-S

HOLZHÄCKSLER MIT VERBRENNUNGSMOTOR

CIP 120-S

BIOTRITURADORA CON MOTOR DE GASOLINA

CIP 120-S

BIO-BROYEUR À MOTEUR À COMBUSTION



ORIGINAL MADE IN ITALY

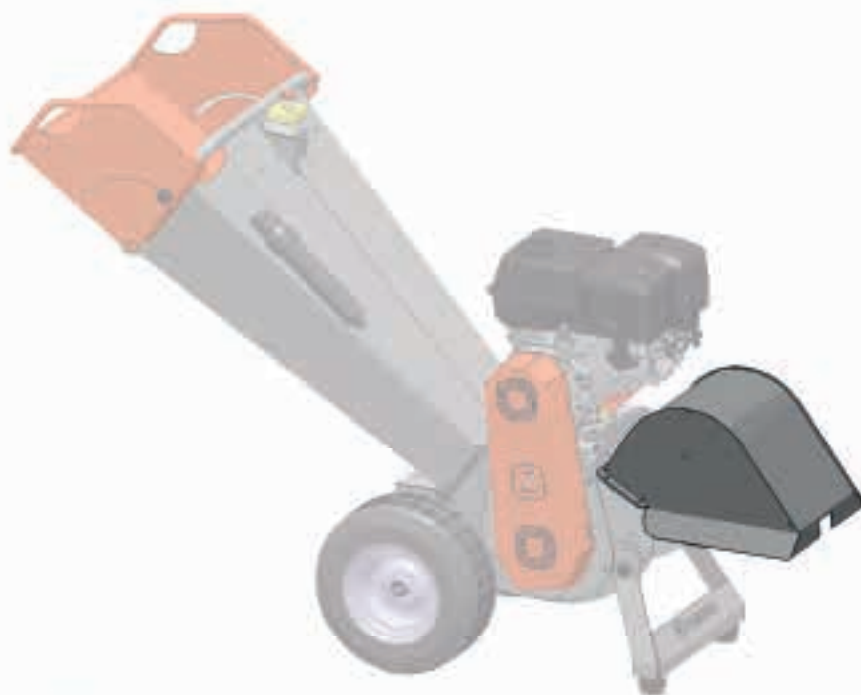

cod. 3233251

On request

Scarico a terra
(per rami con molte foglie)
Ground discharge
(for branches with many leaves)
Bodenauswurf
(für Äste mit vielen Blättern)
Descarga al suelo
(para ramas con muchas hojas)
Décharge au sol (pour les branches
avec beaucoup de feuilles)



cod. 3233240

On request

Bocca di scarico (h=155 cm)
Discharge mouth (h=155 cm)
Entladungsöffnung (h=155 cm)
Boca de descarga (h=155 cm)
Sortie (h=155 cm)

cod. 2051441

On request

Kit traino
(NON OMOLOGATO SU STRADA)
Towing kit
(NOT HOMOLOGATED FOR ROAD HAULAGE)
Abschleppkit
(NICHT AUF DER STRASSE GESTATTET)
Kit de remorque
(NO HOMOLOGADO PARA CARRETERA)
Kit d'attelage
(NON HOMOLOGUÉ POUR LA ROUTE)

cod.	A richiesta	On request	Auf Anfrage	Opcionales	Sur demande
3233251	Scarico a terra	Ground discharge	Bodenauswurf	Descarga al suelo	Décharge au sol
3233240	Bocca di scarico (h=155 cm)	Discharge mouth (h=155 cm)	Entladungsöffnung (h=155 cm)	Boca de descarga (h=155 cm)	Sortie (h=155 cm)
2051441	Kit traino	Towing kit	Abschleppkit	Kit de remorque	Kit d'attelage

cod.	Ricambi	Spare parts	Ersatzteile	Recambios	Pièces de rechange
5023155	Motore LONCIN HP 13	LONCIN HP 13 motor	Motor LONCIN HP 13	Motor LONCIN HP 13	Moteur LONCIN HP 13
5023156	Motore LONCIN HP 14	LONCIN HP 14 motor	Motor LONCIN HP 14	Motor LONCIN HP 14	Moteur LONCIN HP 14
5350301	Controlama	Counterblade	Gegenschlägel	Contracuchilla	Contre-lames
5353103	Frizione	Clutch	Kupplung	Fricción	Embrayage
5354047	Cinghia AX43	Cug belt AX43	Keilriemen AX43	Correa AX43	Courroie AX43



BC 30-E



BC 30-S

BC 30-S



L'apparecchiatura è conforme ai requisiti richiesti dalla direttiva 2000/14/CE per la limitazione del rumore ambientale.







The equipment complies with the requirements of Directive 2000/14/EC for the limitation of environmental noise.

MOD		HP		
mod.	cod.	HP	kg	cm
BC 30-E 220V	1002874	3 (220V)	75	53×125×122
BC 30-E 380V	1002877	3 (380V)	75	53×125×122

Versione con motore elettrico - Electric motor version - Elektromotor Version - Versión motor eléctrico - Version moteur électrique

BC 30-S HP 6,5	1002876	HONDA GP200 HP 6,5	80	53×125×122
BC 30-S HP 6	1003129	BRIGGS & STRATTON XR950 HP 6	80	53×125×122

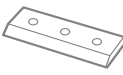
Versione con motore a benzina - Petrol engine version - Benzinmotor Version - Versión motor a gasolina - Version moteur à essence

MOD						
mod.	cm	m ³ /h	rpm/min	nr	nr	nr
BC 30-E 220V	3	2 - 3	2800	6	2	2
BC 30-E 380V	3	2 - 3	2800	6	2	2
BC 30-S	4	2 - 3	3200	6	2	2

Di serie

- Ruote impermeabili
- Setaccio di raffinazione regolabile
- Scarico orientabile
- Controlame a 4 taglienti riposizionabili
- Protezioni antinfortunistiche conformi alla normativa CE

Standard equipment

- Imperforable wheels
- Sieve of adjustable refining
- Adjustable discharge
- Counterblade with 4 repositionable cutting edges
- Protective equipment as per EC safety rules

Serienmässig

- Pannenschutzräder
- Einstellbares Verfeinerungssieb
- Einstellbarer Materialauswurf
- Repositionierbare Gegenklingen mit 4 Schneidkanten
- Unfallschutz nach EU-Vorschriften

Estándar

- Ruedas impermeables
- Tamiz de refinación ajustable
- Descarga ajustable
- Contracuchilla con 4 filos de corte reubicables
- Protecciones de seguridad de acuerdo con la norma CE

De série

- Roues imperforables
- Tamis de raffinage réglable
- Décharge réglable
- Contre-lame avec 4 arêtes de coupe repositionnables
- Protections contre les accidents aux normes CE





cod.	Ricambi	Spare parts	Ersatzteile	Recambios	Pièces de rechange
5350116	Martello	Hammer	Hammer	Martillo	Marteau
5215690	Bussola portamartelli	Hammer-holder bushing	Buchse schneidenhalterung	Porte martillo	Bague porte marteau
5350189	Lama	Blade	Blatt	Cuchilla	Lames
5350190	Controlama	Counterblade	Gegenschlägel	Contracuchilla	Contre-lames
5023113	Motore HONDA HP 6,5	HONDA HP 6,5 motor	HONDA-motor HP 6,5	Motor HONDA HP 6,5	Moteur HONDA HP 6,5
5023103	Motore BRIGGS & STRATTON HP 6	BRIGGS & STRATTON HP 6 motor	BRIGGS & STRATTON motor HP 6	Motor BRIGGS & STRATTON HP 6	Moteur BRIGGS & STRATTON HP 6
5023128	Motore elettrico 220V	Electric motor 220V	Elektromotor 220V	Motor eléctrico 220V	Moteur électrique 220V
5023129	Motore elettrico 380V	Electric motor 380V	Elektromotor 380V	Motor eléctrico 380V	Moteur électrique 380V

NEW

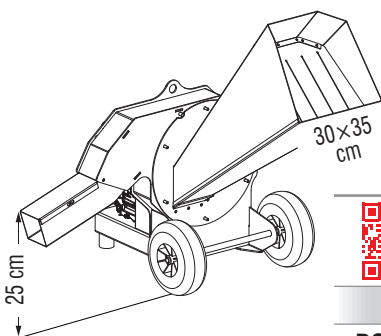
POWERED by
HONDA

POWERED by
LAUNTOP







				
mod.	cod.	HP	kg	cm
BC 50-S HP 6,5	1003179	HONDA GX 200 HP 6,5	110	100×134×113
BC 50-S HP 6	1003670	LAUNTOP HP 6	110	100×134×113

Versione con motore a benzina - Petrol engine version - Benzinmotor Version - Versión motor a gasolina - Version moteur à essence



L'apparecchiatura è conforme ai requisiti richiesti dalla direttiva 2000/14/CE per la limitazione del rumore ambientale.

The equipment complies with the requirements of Directive 2000/14/EC for the limitation of environmental noise.

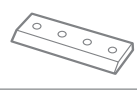
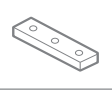
MOD						
mod.	cm	m ³ /h	rpm/min	nr	nr	nr
BC 50-S	5	4	3100	8	2	2

Di serie	Standard equipment	Serienmässig	Estándar	De série
<ul style="list-style-type: none"> Sistema di taglio professionale con lame in acciaio di altissima qualità Ruote imperforabili Setaccio di raffinazione regolabile Controlame Trasmissione a cinghia Protezioni antinfortunistiche conformi alla normativa CE 	<ul style="list-style-type: none"> Professional cutting system with steel blades of the highest quality Imperforable wheels Sieve of adjustable refining Counterblade Belt transmission Protective equipment as per EC safety rules 	<ul style="list-style-type: none"> Profi-Schneidsystem mit Klingen aus hochwertigem Stahl Pannenschutzräder Einstellbares Verfeinerungssieb Gegenklingen Riemenantrieb Unfallschutz nach EU-Vorschriften 	<ul style="list-style-type: none"> Sistema de corte profesional con hojas de acero de la más alta calidad Ruedas imperforables Tamiz de refinación ajustable Contracuchilla Transmisión por correa Protecciones de seguridad de acuerdo con la norma CE 	<ul style="list-style-type: none"> Système de coupe professionnel avec des lames en acier de la plus haute qualité Roues imperforables Tamis de raffinage réglable Contre-lame Transmission par courroie Protections contre les accidents aux normes CE

cod.	Ricambi	Spare parts	Ersatzteile	Recambios	Pièces de rechange
5350116	Martello	Hammer	Hammer	Martillo	Marteau
5350186	Lama	Blade	Blatt	Cuchilla	Lames
5350223	Controlama	Counterblade	Gegenschlägel	Contracuchilla	Contre-lames
5354089	Cinghia BC 50	Cug belt BC 50	Keilriemen BC 50	Correa BC 50	Courroie BC 50
5023093	Motore HONDA HP 6,5	HONDA HP 6,5 motor	HONDA-motor HP 6,5	Motor HONDA HP 6,5	Moteur HONDA HP 6,5
5023139	Motore LAUNTOP HP 6	LAUNTOP HP 6 motor	LAUNTOP-motor HP 6	Motor LAUNTOP HP 6	Moteur LAUNTOP HP 6

NEW



L'apparecchiatura è conforme ai requisiti richiesti dalla direttiva 2000/14/CE per la limitazione del rumore ambientale.

The equipment complies with the requirements of Directive 2000/14/EC for the limitation of environmental noise.

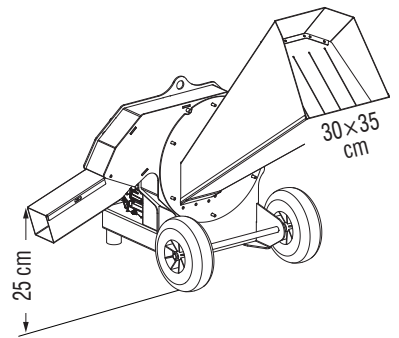

SCAN ME!

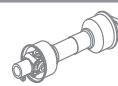

mod.	cod.	HP	type	kg	cm
BC 50-T	1003708	20 - 50	T-40+RL	130	115×134×113

Versione a trattore - Tractor version - Traktorversion - Versión tractor - Version tracteur

MOD

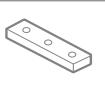
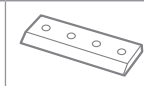

mod.	cm	m ³ /h	rpm/min	nr	nr	nr
BC 50-T	6	4	2850	8	2	2

Di serie

- Sistema di taglio professionale con lame in acciaio di altissima qualità
- Attacco a 3 punti cat. I-II
- Ruote imperforabili
- Setaccio di raffinazione regolabile
- Controlama
- Trasmissione a cinghia
- Protezioni antinfortunistiche conformi alla normativa CE

Standard equipment

- Professional cutting system with steel blades of the highest quality
- 3-point rear linkage cat. I-II
- Imperforable wheels
- Sieve of adjustable refining
- Counterblade
- Belt transmission
- Protective equipment as per EC safety rules

Serienmässig

- Profi-Schneidsystem mit Klingen aus hochwertigem Stahl
- Dreipunktanbaubock Kat. I-II
- Pannenschutzräder
- Einstellbares Verfeinerungssieb
- Gegenklingen
- Riemenantrieb
- Unfallschutz nach EU-Vorschriften

Estándar

- Sistema de corte profesional con hojas de acero de la más alta calidad
- Eenganche de 3 puntos cat. I-II
- Ruedas imperforables
- Tamiz de refinación ajustable
- Contracuchilla
- Transmisión por correa
- Protecciones de seguridad de acuerdo con la norma CE

De série

- Système de coupe professionnel avec des lames en acier de la plus haute qualité
- Attelage à 3 points cat. I-II
- Roues imperforables
- Tamis de raffinage réglable
- Contre-lame
- Transmission par courroie
- Protections contre les accidents aux normes CE

cod.

A richiesta

On request

Auf Anfrage

Opcionales

Sur demande

5130004

Cardano T-40 RL

PTO shaft T-40 RL

Gelenkwelle T-40 RL

Cardán T-40 RL

Cardan T-40 RL

cod.

Ricambi

Spare parts

Ersatzteile

Recambios

Pièces de rechange

5350116

Martello

Hammer

Hammer

Martillo

Marteau

5350186

Lama

Blade

Blatt

Cuchilla

Lames

5350223

Controlama

Counterblade

Gegenschlägel

Contracuchilla

Contre-lames

5354092

Cinghia CTAX26-1/2

Cug belt CTAX26-1/2

Keilriemen CTAX26-1/2

Correa CTAX26-1/2

Courroie CTAX26-1/2



mod.	cod.	HP	kg	cm
BC 60-E 220V	1002858	3 (220V)	120	70×140×120
BC 60-E 380V	1002859	4 (380V)	130	70×140×120

Versione con motore elettrico - Electric motor version - Elektromotor Version - Versión motor eléctrico - Version moteur électrique



L'apparecchiatura è conforme ai requisiti richiesti dalla direttiva 2000/14/CE per la limitazione del rumore ambientale.

The equipment complies with the requirements of Directive 2000/14/EC for the limitation of environmental noise.

MOD						
mod.	cm	m ³ /h	rpm/min	nr	nr	nr
BC 60-E 220V	4	4 - 5	2900	10	2	2
BC 60-E 380V	5	4 - 5	2900	10	2	2

Di serie

- Sistema di taglio professionale con lame in acciaio di altissima qualità
- Ruote imperforabili
- Setaccio di raffinazione regolabile
- Scarico orientabile
- Controlama a 4 taglienti riposizionabili
- Trasmissione a cinghia
- Protezioni antinfortunistiche conformi alla normativa CE

Standard equipment

- Professional cutting system with steel blades of the highest quality
- Imperforable wheels
- Sieve of adjustable refining
- Adjustable discharge
- Counterblade with 4 repositionable cutting edges
- Belt transmission
- Protective equipment as per EC safety rules

Serienmässig

- Profi-Schneidsystem mit Klingen aus hochwertigem Stahl
- Pannenschutzräder
- Einstellbares Verfeinerungssieb
- Einstellbarer Materialauswurf
- Repositionierbare Gegenklingen mit 4 Schneidkanten
- Riemenantrieb
- Unfallschutz nach EU-Vorschriften

Estándar

- Sistema de corte profesional con hojas de acero de la más alta calidad
- Ruedas imperforables
- Tamiz de refinación ajustable
- Descarga ajustable
- Contracuchilla con 4 filos de corte reubicables
- Transmisión por correa
- Protecciones de seguridad de acuerdo con la norma CE

De série

- Système de coupe professionnel avec des lames en acier de la plus haute qualité
- Roues imperforables
- Tamis de raffinage réglable
- Décharge réglable
- Contre-lame avec 4 arêtes de coupe repositionnables
- Transmission par courroie
- Protections contre les accidents aux normes CE

cod.	Ricambi	Spare parts	Ersatzteile	Recambios	Pièces de rechange
5350116	Martello	Hammer	Hammer	Martillo	Marteau
5350186	Lama	Blade	Blatt	Cuchilla	Lames
5350187	Controlama	Counterblade	Gegenschlägel	Contracuchilla	Contre-lames
5354088	Cinghia CTAX28	Cug belt CTAX28	Keilriemen CTAX28	Correa CTAX28	Couroie CTAX28
5023126	Motore elettrico 220V HP3	Electric motor 220V HP3	Elektromotor 220V HP3	Motor eléctrico 220V HP3	Moteur électrique 220V HP3
5023127	Motore elettrico 380V HP4	Electric motor 380V HP4	Elektromotor 380V HP4	Motor eléctrico 380V HP4	Moteur électrique 380V HP4



POWERED by
HONDA

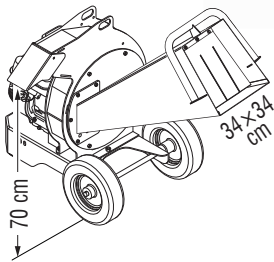

L'apparecchiatura è conforme ai requisiti richiesti dalla direttiva 2000/14/CE per la limitazione del rumore ambientale.

The equipment complies with the requirements of Directive 2000/14/EC for the limitation of environmental noise.

mod.	cod.	HP	kg	cm
BC 60-S HP 6,5	1002857	HONDA GX 200 HP 6,5	135	70×140×120
BC 60-S HP 6,5	1003130	VANGUARD 200 HP 6,5	135	70×140×120

Versione con motore a benzina - Petrol engine version - Benzinmotor Version - Versión motor a gasolina - Version moteur à essence

MOD						
mod.	cm	m ³ /h	rpm/min	nr	nr	nr
BC 60-S	6	4 - 5	3100	10	2	2

Di serie

- Sistema di taglio professionale con lame in acciaio di altissima qualità
- Ruote imperforabili
- Setaccio di raffinazione regolabile
- Scarico orientabile
- Controlame a 4 taglienti riposizionabili
- Trasmissione a cinghia
- Protezioni antinfortunistiche conformi alla normativa CE

Standard equipment

- Professional cutting system with steel blades of the highest quality
- Imperforable wheels
- Sieve of adjustable refining
- Adjustable discharge
- Counterblade with 4 repositionable cutting edges
- Belt transmission
- Protective equipment as per EC safety rules

Serienmässig

- Profi-Schneidsystem mit Klingen aus hochwertigem Stahl
- Pannenschutzräder
- Einstellbares Verfeinerungssieb
- Einstellbarer Materialauswurf
- Repositionierbare Gegenklingen mit 4 Schneidkanten
- Riemenantrieb
- Unfallschutz nach EU-Vorschriften

Estándar

- Sistema de corte profesional con hojas de acero de la más alta calidad
- Ruedas imperforables
- Tamiz de refinación ajustable
- Descarga ajustable
- Contracuchilla con 4 filos de corte reubicables
- Transmisión por correa
- Protecciones de seguridad de acuerdo con la norma CE

De série

- Système de coupe professionnel avec des lames en acier de la plus haute qualité
- Roues imperforables
- Tamis de raffinage réglable
- Décharge réglable
- Contre-lame avec 4 arêtes de coupe repositionnables
- Transmission par courroie
- Protections contre les accidents aux normes CE

cod.	Ricambi	Spare parts	Ersatzteile	Recambios	Pièces de rechange
5350116	Martello	Hammer	Hammer	Martillo	Marteau
5350186	Lama	Blade	Blatt	Cuchilla	Lames
5350187	Controlama	Counterblade	Gegenschlägel	Contracuchilla	Contre-lames
5354089	Cinghia BC 60-S	Cug belt BC 60-S	Keilriemen BC 60-S	Correa BC 60-S	Courroie BC 60-S
5023093	Motore HONDA HP 6,5	HONDA HP 6,5 motor	HONDA-motor HP 6,5	Motor HONDA HP 6,5	Moteur HONDA HP 6,5
5023134	Motore VANGUARD 200 HP 6,5	VANGUARD 200 HP 6,5 motor	VANGUARD 200 -motor HP 6,5	Motor VANGUARD 200 HP 6,5	Moteur VANGUARD 200 HP 6,5



L'apparecchiatura è conforme ai requisiti richiesti dalla direttiva 2000/14/CE per la limitazione del rumore ambientale.

The equipment complies with the requirements of Directive 2000/14/EC for the limitation of environmental noise.

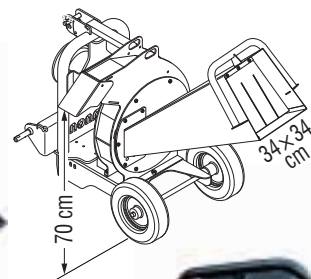

mod.	cod.	HP	type	kg	cm
BC 60-T	1002860	20 - 50	T-40+RL	140	70×140×120

Versione a trattore - Tractor version - Traktorversion - Versión tractor - Version tracteur



MOD						
mod.	cm	m ³ /h	rpm/min	nr	nr	nr
BC 60-T	7	4 - 5	2850	10	2	2

Di serie	Standard equipment	Serienmässig	Estándar	De série
<ul style="list-style-type: none"> Sistema di taglio professionale con lame in acciaio di altissima qualità Attacco a 3 punti cat. I-II Ruote imperforabili Setaccio di raffinazione regolabile Scarico orientabile Controlame a 4 taglienti riposizionabili Trasmissione a cinghia Protezioni antinfortunistiche conformi alla normativa CE 	<ul style="list-style-type: none"> Professional cutting system with steel blades of the highest quality 3-point rear linkage cat. I-II Imperforable wheels Sieve of adjustable refining Adjustable discharge Counterblade with 4 repositionable cutting edges Belt transmission Protective equipment as per EC safety rules 	<ul style="list-style-type: none"> Profi-Schneidsystem mit Klingen aus hochwertigem Stahl Dreipunktanbaock Kat. I-II Pannenschutzräder Einstellbares Verfeinerungssieb Einstellbarer Materialauswurf Repositionierbare Gegenklingen mit 4 Schneidkanten Riemenantrieb Unfallschutz nach EU-Vorschriften 	<ul style="list-style-type: none"> Sistema de corte profesional con hojas de acero de la más alta calidad Enganche de 3 puntos cat. I-II Ruedas imperforables Tamiz de refinación ajustable Descarga ajustable Contracuchilla con 4 filos de corte reubicables Transmisión por correa Protecciones de seguridad de acuerdo con la norma CE 	<ul style="list-style-type: none"> Système de coupe professionnel avec des lames en acier de la plus haute qualité Attelage à 3 points cat. I-II Roues imperforables Tamis de raffinage réglable Décharge réglable Contre-lame avec 4 arêtes de coupe repositionnables Transmission par courroie Protections contre les accidents aux normes CE

cod.	A richiesta	On request	Auf Anfrage	Opcionales	Sur demande
5130004	Cardano T-40 RL	PTO shaft T-40 RL	Gelenkwelle T-40 RL	Cardán T-40 RL	Cardan T-40 RL

cod.	Ricambi	Spare parts	Ersatzteile	Recambios	Pièces de rechange
5350116	Martello	Hammer	Hammer	Martillo	Marteau
5350186	Lama	Blade	Blatt	Cuchilla	Lames
5350187	Controlama	Counterblade	Gegenschlägel	Contracuchilla	Contre-lames
5354088	Cinghia BC 60-T	Cug belt BC 60-T	Keilriemen BC 60-T	Correa BC 60-T	Courroie BC 60-T

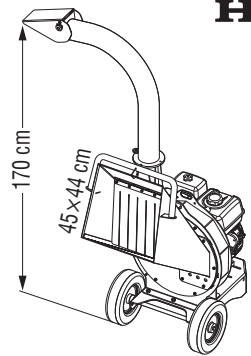

POWERED by
HONDA



WWW.ZANON.IT



Di serie	Standard equipment	Serienmässig	Estándar	De série
<ul style="list-style-type: none"> Sistema di taglio professionale con lame in acciaio di altissima qualità Frizione ad espansione per facilitare l'accensione Ruote impermeabili Setaccio di raffinazione regolabile Scarico orientabile Controlame a 4 taglienti riposizionabili Trasmissione a cinghia Protezioni antifuoribuscanti conformi alla normativa CE 	<ul style="list-style-type: none"> Professional cutting system with steel blades of the highest quality Expansion clutch to simplify startup Imperforable wheels Sieve of adjustable refining Adjustable discharge Counterblade with 4 repositionable cutting edges Belt transmission Protective equipment as per CE safety rules 	<ul style="list-style-type: none"> Profi-Schneidsystem mit Klingen aus hochwertigem Stahl Fliehkraftkupplung für leichtes Starten Pannenschutzräder Einstellbares Verfeinerungssieb Einstellbarer Materialauswurf Repositionierbare Gegenklingen mit 4 Schneidkanten Riemenantrieb Unfallschutz nach EU-Vorschriften 	<ul style="list-style-type: none"> Sistema de corte profesional con hojas de acero de la más alta calidad Embrague de expansión para facilitar el encendido. Ruedas impermeforables Tamiz de refinación ajustable Descarga ajustable Contracuchilla con 4 filos de corte reubicables Transmisión por correa Protecciones de seguridad de acuerdo con la norma CE 	<ul style="list-style-type: none"> Système de coupe professionnel avec des lames en acier de la plus haute qualité Embrayage à expansion facilitant le démarrage Roues imperforables Tamis de raffinage réglable Décharge réglable Contre-lame avec 4 arêtes de coupe repositionnables Transmission par courroie Protections contre les accidents aux normes CE



L'apparecchiatura è conforme ai requisiti richiesti dalla direttiva 2000/14/CE per la limitazione del rumore ambientale.

The equipment complies with the requirements of Directive 2000/14/EC for the limitation of environmental noise.









SCAN ME!



mod.	cod.	HP	kg	cm
BC 90-S HP 13	1002900	HONDA GX 390 HP 13	210	75×134×180
BC 90-S HP 14	1003131	VANGUARD 400 HP 14	210	75×134×180

Versione con motore a benzina - Petrol engine version - Benzinmotor Version - Versión motor a gasolina - Version moteur à essence

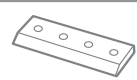

MOD						
mod.	cm	m ³ /h	rpm/min	nr	nr	nr
BC 90-S	9	5 - 6	3100	10	2	2

cod.	Ricambi	Spare parts	Ersatzteile	Recambios	Pièces de rechange
5350116	Martello	Hammer	Hammer	Martillo	Marteau
5350192	Lama	Blade	Blatt	Cuchilla	Lames
5350191	Controlama	Counterblade	Gegenschlägel	Contracuchilla	Contre-lames
5354093	Cinghia BC 90-S	Cug belt BC 90-S	Keilriemen BC 90-S	Correa BC 90-S	Courroie BC 90-S
5023077	Motore HONDA HP 13	HONDA HP 13 motor	HONDA-motor HP 13	Motor HONDA HP 13	Moteur HONDA HP 13
5023135	Motore VANGUARD 400 HP 14	VANGUARD 400 HP 14 motor	VANGUARD 400-motor HP 14	Motor VANGUARD 400 HP 14	Moteur VANGUARD 400 HP 14

NEW



Di serie

- Sistema di taglio professionale con lame in acciaio di altissima qualità
- Attacco a 3 punti cat. I-II
- Scatola ingranaggi a bagno d'olio
- Ruote imperforabili
- Setaccio di raffinazione regolabile
- Scarico orientabile
- Controlame a 4 taglianti riposizionabili
- Trasmissione a cinghia
- Protezioni antinfortunistiche conformi alla normativa CE

Serienmässig

- Profi-Schneidsystem mit Klingen aus hochwertigem Stahl
- Dreipunktanbaubock Kat. I-II
- Zahnradgehäuse im Ölbad
- Pannenschutzräder
- Einstellbares Verfeinerungssieb
- Einstellbarer Materialauswurf
- Repositionierbare Gegenklingen mit 4 Schneidkanten
- Riemenantrieb
- Unfallschutz nach EU-Vorschriften

Standard equipment

- Professional cutting system with steel blades of the highest quality
- 3-point rear linkage cat. I-II
- Gear box in an oil bath
- Imperforable wheels
- Sieve of adjustable refining
- Adjustable discharge
- Counterblade with 4 repositionable cutting edges
- Belt transmission
- Protective equipment as per EC safety rules

Estándar

- Sistema de corte profesional con hojas de acero de la más alta calidad
- Enganche de 3 puntos cat. I-II
- Caja de engranajes en baño de aceite
- Ruedas imperforables
- Tamiz de refinación ajustable
- Descarga ajustable
- Contracuchilla con 4 filos de corte reubicables
- Transmisión por correa
- Protecciones de seguridad de acuerdo con la norma CE

De série

- Système de coupe avec des lames en acier de la plus haute qualité
- Attelage à 3 points cat. I-II
- Boîte d'engrenages dans bain d'huile
- Roues imperforables
- Tamis de raffinage réglable
- Décharge réglable
- Contre-lame avec 4 arêtes de coupe repositionnables
- Transmission par courroie
- Protections contre les accidents aux normes CE



L'apparechiatura è conforme ai requisiti richiesti dalla direttiva 2000/14/CE per la limitazione del rumore ambientale.

The equipment complies with the requirements of Directive 2000/14/EC for the limitation of environmental noise.



SCAN ME!

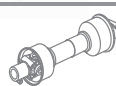

mod.	cod.	HP	type	kg	cm
BC 90-T	1002899	20 - 50	T-40+RL	220	70×140×120

Versione a trattore - Tractor version - Traktorversion - Versión tractor - Version tracteur

MOD						
mod.	cm	m ³ /h	rpm/min	nr	nr	nr
BC 90-T	10	5 - 6	2850	10	2	2



cod.	A richiesta	On request	Auf Anfrage	Opcionales	Sur demande
5130004	Cardano T-40 RL	PTO shaft T-40 RL	Gelenkwelle T-40 RL	Cardán T-40 RL	Cardan T-40 RL

cod.	Ricambi	Spare parts	Ersatzteile	Recambios	Pièces de rechange
5350116	Martello	Hammer	Hammer	Martillo	Marteau
5350192	Lama	Blade	Blatt	Cuchilla	Lames
5350191	Controlama	Counterblade	Gegenschlägel	Contracuchilla	Contre-lames
5354091	Cinghia BC 90-T	Cug belt BC 90-T	Keilriemen BC 90-T	Correa BC 90-T	Courroie BC 90-T



Cassone ribaltabile
Collapsible box
Faltbare box
Caja plegable
Boîte pliable

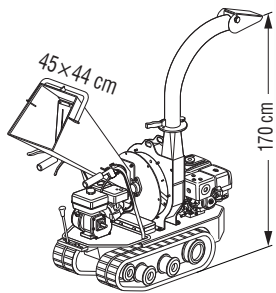











L'apparecchiatura è conforme ai requisiti richiesti dalla direttiva 2000/14/CE per la limitazione del rumore ambientale.

The equipment complies with the requirements of Directive 2000/14/EC for the limitation of environmental noise.



POWERED by **HONDA**

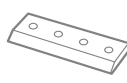

	SCAN ME!		HP			
mod.	cod.	HP	kg	cm		
BC 90-CINGO HP 13	1002934	HONDA GX 390 HP 13	350	75×134×180		
BC 90-CINGO HP 14	1003132	VANGUARD 400 HP 14	350	75×134×180		
MOD						
mod.	cm	m ³ /h	rpm/min	nr	nr	nr
BC 90-CINGO	9	5 - 6	3100	10	2	2

Di serie	Standard equipment	Serienmässig	Estándar	De série	
<ul style="list-style-type: none"> Setaccio di raffinazione regolabile Scarico orientabile Controlame a 4 taglienti riposizionabili Trasmissione a cinghia Frizione ad espansione per facilitare l'avviamento Carrello cingolato con 3 marce avanti 1 indietro Freni di stazionamento automatici Regolazione automatica tensionamento cingoli Cassone ribaltabile Protezioni antifornitistiche conformi alla normativa CE 	<ul style="list-style-type: none"> Adjustable refining sieve Adjustable exhaust 4 Repositionable cutting edges Belt drive Expanding clutch to facilitate starting Crawler truck with 3 forward gears 1 back Automatic parking brakes Automatic track tension adjustment Collapsible box Protective equipment as per EC safety rules 	<ul style="list-style-type: none"> Verstellbares raffinationssieb Einstellbarer auspuff 4 Umpositionierbare schneidkanten Riemenantrieb Spreizkupplung um den startvorgang zu erleichtern Raupenwagen mit 3 vorwärtsgängen 1 rückwärtsgang Automatische feststellbremse Automatische einstellung der kettenspannung Faltbare box Unfallschutz nach EU-Vorschriften 	<ul style="list-style-type: none"> Tamiz de refinación ajustable Escape ajustable 4 Filos de corte reposicionables Transmisión por correa Embrague de expansión para facilitar el arranque Camión de oruga con 3 engranajes delanteros 1 atrás Frenos de estacionamiento automáticos Ajuste automático de la tensión de la pista Caja plegable Protecciones de seguridad de acuerdo con la norma CE 	<ul style="list-style-type: none"> Tamis de raffinage ajustable Échappement réglable 4 Tranchants repositionnables Entraînement par courroie Embrayage à expansion facilitant le démarrage Chariot sur chenilles avec 3 vitesses avant 1 arrière Freins de stationnement automatiques Réglage automatique de la tension des chenilles Boîte pliable Protections contre les accidents aux normes CE 	
cod.	Ricambi	Spare parts	Ersatzteile	Recambios	Pièces de rechange
5350116	Martello	Hammer	Hammer	Martillo	Marteau
5350192	Lama	Blade	Blatt	Cuchilla	Lames
5350191	Controlama	Counterblade	Gegenschlägel	Contracuchilla	Contre-lames
5354092	Cinghia BC 90-CINGO	Cug belt BC 90-CINGO	Keilriemen BC 90-CINGO	Correa BC 90-CINGO	Courroie BC 90-CINGO
5023077	Motore HONDA HP 13	HONDA HP 13 motor	HONDA-motor HP 13	Motor HONDA HP 13	Moteur HONDA HP 13
5023135	Motore VANGUARD 400 HP 14	VANGUARD 400 HP 14 motor	VANGUARD 400-motor HP 14	Motor VANGUARD 400 HP 14	Moteur VANGUARD 400 HP 14

MINI-DUMPER MOTORIZZATO

DP 300



ORIGINAL MADE IN ITALY

MOTORISED MINI-DUMPER

MINIRAUPENDUMPER

MINIDUMPER MOTORIZADO

MINI-TOMBREAU MOTORISÉ



Cassone ribaltabile
Collapsible box
Faltbare box
Caja plegable
Boîte pliable



mod.	cod.	HP	kg	cm
DP 300	5446023	HP 6,5 - 200 cm ³	178	160×65×95

Dati tecnici	Technical data	Technische Daten	Datos técnicos	Données techniques
Carico massimo	Max load	Maximale Last	Carga máxima	Charge maximale 300 kg
Dimensioni cassone chiuso	Closed box dimensions	Abmessungen geschlossener Kasten	Dimensiones caja cerrada	Dimensions de la boîte fermée 91×60×20 cm
Dimensioni cassone aperto	Open box dimensions	Abmessungen offener Kasten	Dimensiones caja abierta	Dimensions de la boîte ouvert 104×86×20 cm
Marce	Speed	Getriebe	Velocidad	Vitesse 3 + 1
Larghezza cingoli	Track width	Spurbreite	Ancho de la pista	Largueur de la piste 180 mm

Di serie	Standard equipment	Serienmässig	Estándar	De série
<ul style="list-style-type: none"> Carrello cingolato con 3 marce avanti 1 indietro Freni di stazionamento automatici Regolazione automatica tensionamento cingoli Cassone ribaltabile Protezioni antinfortunistiche conformi alla normativa CE 	<ul style="list-style-type: none"> Crawler truck with 3 forward gears 1 back Automatic parking brakes Automatic track tension adjustment Collapsible box Protective equipment as per EC safety rules 	<ul style="list-style-type: none"> Raupenwagen mit 3 vorwärtsgängen 1 rückwärtsgang Automatische feststellbremse Automatische einstellung der kettenspannung Faltbare box Unfallschutz nach EU-Vorschriften 	<ul style="list-style-type: none"> Camión de oruga con 3 engranajes delanteros 1 atrás Frenos de estacionamiento automáticos Ajuste automático de la tensión de la pista Caja plegable Protecciones de seguridad de acuerdo con la norma CE 	<ul style="list-style-type: none"> Chariot sur chenilles avec 3 vitesses avant 1 arrière Freins de stationnement automatiques Réglage automatique de la tension des chenilles Boîte pliable Protections contre les accidents aux normes CE

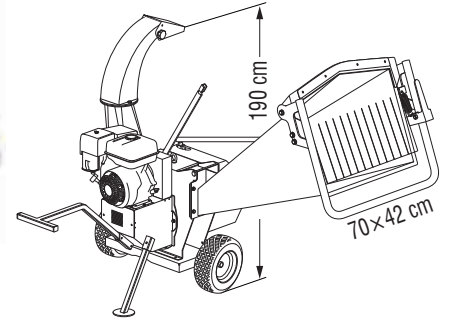

Maniglione di sicurezza
Safety handle
Sicherheitsgriff
Manilla de seguridad
Arceau de sécurité

BIO 8-B	13 HP Petrol engine
BIO 8-B	Motor-gasoline 13 HP
BIO 8-B	Motor de gasolina 13 HP
BIO 8-B	Moteur à essence 13 HP

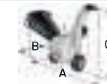





mod.	cod.	HP	kg	cm
BIO 8-B *	1002371	HONDA GX 390 HP 13	250	200×112×190
BIO 8-B **	1002374	HONDA GX 390 HP 13	250	200×112×190

* Avviamento a strappo - Starting with rope - Manueller Start - Arranque manual - Démarrage à lancer

** Avviamento elettrico - Electric starter - Elektrostart - Arranque eléctrico - Démarrage électrique

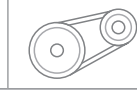

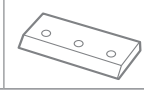
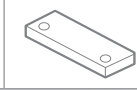
MOD							
mod.	cm	m ³ /h	rpm/min	nr (type)	nr	nr	nr
BIO 8-B	8,5	6 - 5	2850	2 (XPA 1032)	12	3	1

Di serie	Standard equipment	Serienmässig	Estándar	De série
<ul style="list-style-type: none"> • Ruote per spostamento • Tubo di scarico registrabile • Filtro olio a cartuccia • Frizione centrifuga per stacco automatico • Avanzamento rullo regolabile idraulicamente • Protezioni antinfortunistiche conformi alla normativa CE 	<ul style="list-style-type: none"> • Transfer wheels • Adjustable discharge pipe • Oil cartridge filter • Centrifugal clutch for automatic detachment • Adjustable working-speed controlled by hydraulic system • Protective equipment as per EC safety rules 	<ul style="list-style-type: none"> • Satz Hinterräder • Regulierbares Entladungsrohr • Ölfilterkartusche • Fliehkraftkupplung für automatische Absonderung • Hydraulisch einstellbarer Walzenvorschub • Unfallschutz nach EU-Vorschriften 	<ul style="list-style-type: none"> • Ruedas de transporte • Tubo de descarga orientable • Filtro de aceite (cartucho) • Embrague centrífugo para desacoplamiento automático • Rodillo de alimentación con regulación hidráulico. • Protecciones de seguridad de acuerdo con la norma CE 	<ul style="list-style-type: none"> • Roues de déplacement • Tuyau d'échappement réglable • Filtre à huile à cartouche • Friction centrifuge pour décrochage automatique • Avancement rouleau réglable hydrauliquement • Protections contre les accidents aux normes CE



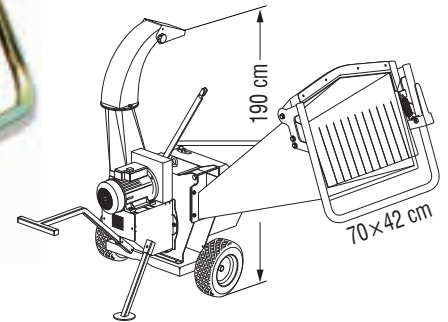

cod.	Ricambi	Spare parts	Ersatzteile	Recambios	Pièces de rechange
5023072	Motore orbitale	Orbital motor	Motor augenhöhlen	Motor orbital	Motor orbitaire
5023077	Motore HONDA avviamento a strappo	Motor HONDA starting with rope	Motor HONDA manueller Start	Motor HONDA arranque manual	Moteur HONDA démarrage à lancer
5023070	Motore HONDA avviamento elettrico	Motor HONDA electric starter	Motor HONDA Elektrostart	Motor HONDA arranque eléctrico	Moteur HONDA démarrage électrique
5210289	Lama	Blade	Blatt	Cuchilla	Lames
5210290	Controlama	Counterblade	Gegenschlägel	Contracuchilla	Contre-lames
5226590	Martello	Hammer	Hammer	Martillo	Marteau
5353103	Frizione BIO-8	Clutch BIO-8	Kupplung BIO-8	Fricción BIO-8	Embrayage BIO-8
5354051	Cinghia XPA-1032	Belt XPA-1032	Riemen XPA-1032	Correa XPA-1032	Courroie XPA-1032
5411020	Ruota	Wheel	Rad	Rueda	Roue
5433015	Cartuccia filtro olio	Cartridge filter oil	Patrine Filterölfilter	Cartucho filtro aceite	Huile du filtre de la cartouche
5433014	Filtro olio completo	Complete filter oil	Filterölfilter	Filtro aceite completo	Huile du filtre complète
2131005	Accoppiamento rotore pompa	Attachment rotor-pump	Rotor befestigungs pumpe	Conexión bomba / motor	Attelage pompe / rotor









Maniglione di sicurezza
Safety handle
Sicherheitsgriff
Manilla de seguridad
Arceau de sécurité

BIO 8-E	With 10 HP electric three-phase motor
BIO 8-E	Elektrischer dreiphasiger Motor 10 HP
BIO 8-E	Motor eléctrico trifásico 10 HP
BIO 8-E	Moteur électrique triphasé 10 HP

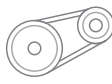

				
mod.	cod.	HP	kg	cm
BIO 8-E	1002372	HP 10 - 380V	230	200×112×190

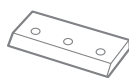
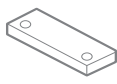
							
mod.	cm	m ³ /h	rpm/min	nr (type)	nr	nr	nr
BIO 8-E	8,5	6 - 5	2850	2 (XPA 1032)	12	3	1



Di serie	Standard equipment	Serienmässig	Estándar	De série
<ul style="list-style-type: none"> Ruote per spostamento Tubo di scarico registrabile Filtro olio a cartuccia Avanzamento rullo regolabile idraulicamente Protezioni antinfortunistiche conformi alla normativa CE 	<ul style="list-style-type: none"> Transfer wheels Adjustable discharge pipe Oil cartridge filter Adjustable working-speed controlled by hydraulic system Protective equipment as per EC safety rules 	<ul style="list-style-type: none"> Satz Hinterräder Regulierbares Entladungsrohr Ölfilterkartusche Hydraulisch einstellbarer Walzenvorschub Unfallschutz nach EU-Vorschriften 	<ul style="list-style-type: none"> Ruedas de transporte Tubo de descarga orientable Filtro de aceite (cartucho) Rodillo de alimentación con regulación hidráulico. Protecciones de seguridad de acuerdo con la norma CE 	<ul style="list-style-type: none"> Roues de déplacement Tuyau d'échappement réglable Filtre à huile à cartouche Avancement rouleau réglable hydrauliquement Protections contre les accidents aux normes CE

cod.	Ricambi	Spare parts	Ersatzteile	Recambios	Pièces de rechange
5023072	Motore orbitale	Orbital motor	Motor augenhöhlen	Motor orbital	Motor orbitaire
5023073	Motore elettrico 10 HP 380V	Electric motor 10 HP 380V	Motor 10 HP 380V	Motor eléctrico 10 HP 380V	Mateur électrique 10 HP 380V
5210289	Lama	Blade	Blatt	Cuchilla	Lames
5210290	Controlama	Counterblade	Gegenschlägel	Contracuchilla	Contre-lames
5226590	Martello	Hammer	Hammer	Martillo	Marteau
5354052	Cinghia AX 41 1/2 Dentellata	Belt AX 41 1/2 Dentellata	Riemen AX 41 1/2 Dentellata	Correa AX 41 1/2 Dentellata	Courroie AX 41 1/2 Dentellata
5411020	Ruota	Wheel	Rad	Rueda	Roue
5433015	Cartuccia filtro olio	Cartridge filter oil	Patrine Filterölfilter	Cartucho filtro aceite	Huile du filtre de la cartouche
5433014	Filtro olio completo	Complete filter oil	Filterölfilter	Filtro aceite completo	Huile du filtre complète
2131005	Accoppiamento rotore pompa	Attachment rotor-pump	Rotor befestigungs pumpe	Conexión bomba / motor	Attelage pompe / rotor





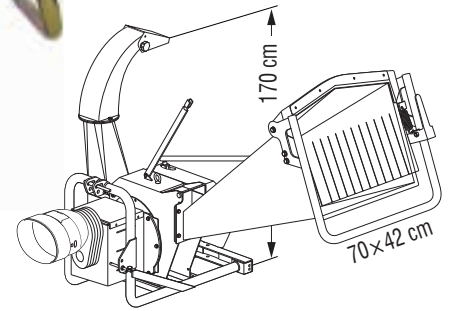



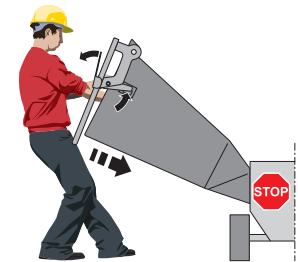

Maniglione di sicurezza
Safety handle
Sicherheitsgriff
Manilla de seguridad
Arceau de sécurité

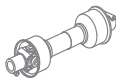

BIO 8-T	Tractor
BIO 8-T	Traktor
BIO 8-T	Tractor
BIO 8-T	Tracteur

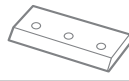
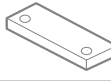

						
mod.	cod.	HP	type	kg	cm	
BIO 8-T	1002370	30 - 80	T-40+RL	270	200×112×190	
MOD						
mod.	cm	m³/h	rpm/min	nr	nr	nr
BIO 8-T	8,5	6 - 5	2850	12	3	1

Di serie	Standard equipment	Serienmässig	Estándar	De série
<ul style="list-style-type: none"> Attacco a 3 punti cat. I-II Tubo di scarico registrabile Filtro olio a cartuccia Scatola ingranaggi a bagno d'olio Gancio traino Avanzamento rullo regolabile idraulicamente Protezioni antinfortunistiche conformi alla normativa CE 	<ul style="list-style-type: none"> 3-point rear linkage cat. I-II Adjustable discharge pipe Oil cartridge filter Oil bath gear box Tow hook Adjustable Working-speed controlled by hydraulic system. Protective equipment as per EC safety rules 	<ul style="list-style-type: none"> Dreipunktanbauck Kat. I-II Regulierbares Entladungsrohr Ölfilterkartusche Ölbad-Getriebe Anhänggekupplung Hydraulisch einstellbarer Walzenvorschub Unfallschutz nach EU-Vorschriften 	<ul style="list-style-type: none"> Eganche de 3 puntos cat. I-II Tubo de descarga orientable Filtro de aceite (cartucho) Caja de engranajes Gancho de remolque Rodillo de alimentación con regulación hidráulico. Protecciones de seguridad de acuerdo con la norma CE 	<ul style="list-style-type: none"> Attelage à 3 points cat. I-II Tuyau d'échappement réglable Filtre à huile à cartouche Boîtier engrenages à bain d'huile Crochet de remorquage Avancement rouleau réglable hydrauliquement Protections contre les accidents aux normes CE

cod.	A richiesta	On request	Auf Anfrage	Opcionales	Sur demande
5130004	Cardano T-40 RL	PTO shaft T-40 RL	Gelenkwelle T-40 RL	Cardán T-40 RL	Cardan T-40 RL
cod.	Ricambi	Spare parts	Ersatzteile	Recambios	Pièces de rechange
5023072	Motore orbitale	Orbital motor	Motor augenhöhlen	Motor orbital	Motor orbitaire
2020046	Scatola ingranaggi	Gearbox	Ölbad-Getriebe	Caja de engranajes	Bôte d'engrenages
5210289	Lama	Blade	Blatt	Cuchilla	Lames
5210290	Controlama	Counterblade	Gegenschlägel	Contracuchilla	Contre-lames
5226590	Martello	Hammer	Hammer	Martillo	Marteau
5421011	Pompa idraulica	Idraulic pump	Rad	Bomba hidraulica	Pompe idraulique
5433015	Cartuccia filtro olio	Cartridge filter oil	Patrine Filterölfilter	Cartucho filtro aceite	Huile du filtre de la cartouche
5433014	Filtro olio completo	Complete filter oil	Filterölfilter	Filtro aceite completo	Huile du filtre complète
2131004	Accoppiam. moltiplicatore-rotore	Attachment rotor-multiplier	Befestigungs rotor vermehrer	Acoplamiento rotor-multiplicador	Accouplem. multiplicateur-rotor

POWERED by
HONDA

Maniglione di sicurezza
Safety handle
Sicherheitsgriff
Manilla de seguridad
Arceau de sécurité





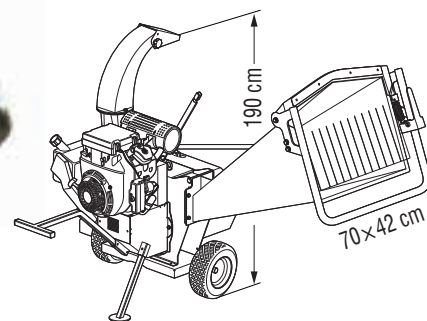

L'apparecchiatura è conforme ai requisiti richiesti dalla direttiva 2000/14/CE per la limitazione del rumore ambientale.





The equipment complies with the requirements of Directive 2000/14/EC for the limitation of environmental noise.

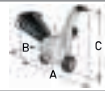

BIO 10-B	20 HP Petrol engine
BIO 10-B	Motor-gasoline 20 HP
BIO 10-B	Motor de gasolina 20 HP
BIO 10-B	Moteur à essence 20 HP

				
mod.	cod.	HP	kg	cm
BIO 10-B *	1002388	HP 20 HONDA GX 630	320	200×112×190

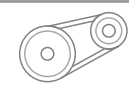
* Avviamento elettrico - Electric starter - Elektrostart - Arranque eléctrico - Démarrage électrique

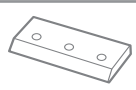
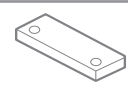
MOD							
mod.	cm	m ³ /h	rpm/min	nr (type)	nr	nr	nr
BIO 10-B	8,5	6 - 5	2850	2 (XPA 1082)	12	3	1

Di serie	Standard equipment	Serienmässig	Estándar	De série
<ul style="list-style-type: none"> Avviamento elettrico Ruote per spostamento Tubo di scarico registrabile Filtro olio a cartuccia Frizione centrifuga per stacco automatico Avanzamento rullo regolabile idraulicamente Protezioni antinfortunistiche conformi alla normativa CE 	<ul style="list-style-type: none"> Electric start Transfer wheels Adjustable discharge pipe Oil cartridge filter Centrifugal clutch for automatic detachment Adjustable working-speed controlled by hydraulic system Protective equipment as per EC safety rules 	<ul style="list-style-type: none"> Elektrostart Satz Hinterräder Regulierbares Entladungsrohr Ölfilterkartusche Fliehkraftkupplung für automatische Absonderung Hydraulisch einstellbarer Walzenvorschub Unfallschutz nach EU-Vorschriften 	<ul style="list-style-type: none"> Arranque eléctrico Ruedas de transporte Tubo de descarga orientable Filtro de aceite (cartucho) Embrague centrifugo para desacoplamiento automático Rodillo de alimentación con regulación hidráulico. Protecciones de seguridad de acuerdo con la norma CE 	<ul style="list-style-type: none"> Démarrage électrique Roues de déplacement Tuyau d'échappement réglable Filtre à huile à cartouche Friction centrifuge pour décrochage automatique Avancement rouleau réglable hydrauliquement Protections contre les accidents aux normes CE

cod.	Ricambi	Spare parts	Ersatzteile	Recambios	Pièces de rechange
5023072	Motore orbitale	Orbital motor	Motor augenhöhlen	Motor orbital	Motor orbitaire
5023087	Motore HONDA 20 HP avv. elettrico	Motor HONDA 20 HP elec. starter	Motor HONDA 20 HP Elektrostart	Motor HONDA 20 HP arr. eléctrico	Moteur HONDA 20 HP dém. élect.
5210289	Lama	Blade	Blatt	Cuchilla	Lames
5210290	Controlama	Counterblade	Gegenschlägel	Contracuchilla	Contre-lames
5226590	Martello	Hammer	Hammer	Martillo	Marteau
5353113	Frizione BIO 10	Clutch BIO 10	Kupplung BIO 10	Fricción BIO 10	Embrayage BIO 10
5354059	Cinghia XPA 1082	Belt XPA 1082	Riemen XPA 1082	Correa XPA 1082	Courroie XPA 1082
5411020	Ruota	Wheel	Rad	Rueda	Roue
5433015	Cartuccia filtro olio	Cartridge filter oil	Patrine Filterölfilter	Cartucho filtro aceite	Huile du filtre de la cartouche
5433014	Filtro olio completo	Complete filter oil	Filterölfilter	Filtro aceite completo	Huile du filtre complète
2131005	Accoppiamento rotore pompa	Attachment rotor-pump	Rotor befestigungs pumpe	Conexión bomba / motor	Attelage pompe / rotor

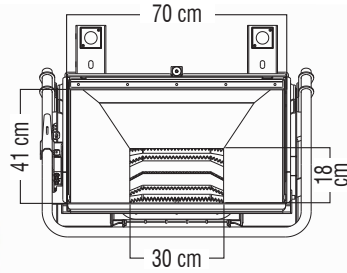





Maniglione di sicurezza
Safety handle
Sicherheitsgriff
Manilla de seguridad
Arceau de sécurité

POWERED by
HONDA



L'apparecchiatura è conforme ai requisiti richiesti dalla direttiva 2000/14/CE per la limitazione del rumore ambientale.

The equipment complies with the requirements of Directive 2000/14/EC for the limitation of environmental noise.

				
mod.	cod.	HP	kg	cm
BIO 130-S	1003992	HONDA GX 630CC HP 20	480	87×180×150

Di serie	Standard equipment	Serienmässig	De serie	De série
<ul style="list-style-type: none"> • Motore a benzina HONDA • Avanzamento del materiale con rullo pick up gestito elettronicamente da sistema «NO STRESS» • Carrello semovente con differenziale idraulico per facilitare lo spostamento • Sistema di taglio composto da 36 martelli, 3 lame e 1 controlama • Centralina elettronica di controllo triturazione • Tubo di scarico regolabile • Timone per lo spostamento della macchina dotato di sistema di protezione a due mani • Tramoggia, timone e tubo di scarico ripiegabili per ridurre l'ingombro della macchina • Protezioni antinfortunistiche conformi alla normativa CE 	<ul style="list-style-type: none"> • HONDA petrol engine • Material feed with pick-up roller electronically controlled by 'NO STRESS' system • Self-propelled trolley with hydraulic differential for easy movement • Cutting system comprising 36 hammers, 3 blades and 1 counter-blade • Electronic shredding control unit • Adjustable discharge pipe • Drawbar for moving the machine equipped with two-hand protection system • Foldable hopper, drawbar and discharge pipe to reduce machine dimensions • Protective equipment as per EC safety rules 	<ul style="list-style-type: none"> • HONDA-Benzinmotor • Materialzufuhr mit elektronisch gesteuerter Aufnahmewalze durch 'NO STRESS'-System • Selbstfahrender Wagen mit hydraulischem Differential für einfache Bewegung • Schneidsystem bestehend aus 36 Hämmern, 3 Klingen und 1 Gegenmesser • Elektronische Zerkleinerungssteuerung • Einstellbares Auswurfrohr • Deichsel zum Bewegen der Maschine, ausgestattet mit einem Zweihand-Schutzsystem • Klappbarer Trichter, Deichsel und Auswurfrohr zur Reduzierung des Platzbedarfs der Maschine • Unfallschutz nach EU-Vorschriften 	<ul style="list-style-type: none"> • Motor de gasolina HONDA • Alimentación de material con rodillo de recogida controlado electrónicamente por el sistema "NO STRESS". • Carro autopropulsado con diferencial hidráulico para facilitar el desplazamiento • Sistema de corte compuesto por 36 martillos, 3 cuchillas y 1 contracuchilla • Unidad electrónica de control de trituración • Tubo de descarga ajustable • Barra de tracción para desplazar la máquina equipada con sistema de protección bimanual • Tolva, lanza y tubo de descarga plegables para reducir el espacio ocupado por la máquina • Protecciones de seguridad de acuerdo con la norma CE 	<ul style="list-style-type: none"> • Moteur à essence HONDA • Avancement du matériel avec rouleau de ramassage contrôlé électroniquement par le système «NO STRESS» • Chariot autottracté avec différentiel hydraulique pour faciliter le déplacement • Système de coupe composé de 36 marteaux, 3 lames et 1 contre-lame • Unité de contrôle électronique du broyage • Tuyau de décharge réglable • Timon pour le déplacement de la machine équipé d'un système de protection bimanuelle • Trémie, timon et tuyau de décharge repliables pour réduire l'encombrement de la machine • Protections contre les accidents conformes aux normes CE

BIO 130-S	<i>Self-propelled Bio-Shredder with petrol engine</i>
BIO 130-S	Selbstfahrender Bio-Häcksler mit Benzinmotor
BIO 130-S	<i>Biotrituradora semipropulsada con motor de gasolina</i>
BIO 130-S	Bio-Broyeur autotracté avec moteur à essence



Impiego	Use	Verwendung	Uso	Emploi
---------	-----	------------	-----	--------

Il biotrituratore BIO 130-S permette di ridurre del 45% il volume degli scarti vegetali. Consente di triturare residui di potatura di vite, olivo, pino o palma, e rifiuti vegetali anche umidi e fibrosi oppure per la distruzione di rami verdi, aventi un diametro massimo di 13 cm.

La tramoggia è posizionata ad altezza adeguata per ridurre lo sforzo di sollevamento del materiale da tritare durante il lavoro.

Il rullo di trascinamento idraulico, il cui senso di rotazione viene controllato elettronicamente mediante un maniglione che funge anche da blocco di sicurezza del trascinamento, è collegato ad una centralina elettronica «NO STRESS» che regola automaticamente l'avanzamento del materiale in base allo sforzo di triturazione.

The BIO 130-S bio-shredder reduces the volume of plant waste by 45%. It allows the shredding of vine, olive, pine or palm tree pruning residue, as well as vegetable waste, including wet and fibrous waste, or the destruction of dry branches up to 15 cm in diameter.

The hopper is positioned at a suitable height to reduce the effort required to lift the material to be shredded during work.

The hydraulic drive roller, whose rotation direction is electronically controlled by a handle that also acts as a safety lock on the drive, is connected to a 'NO STRESS' electronic control unit that automatically adjusts the material feed according to the shredding effort.

Der Biohäcksler BIO 130-S ermöglicht es, das Volumen der pflanzlichen Abfälle um 45 % zu reduzieren. Er kann für die Häckselung von Reb-, Oliven-, Kiefern- oder Palmenchnittresten und pflanzlichen Abfällen, einschließlich nasser und faseriger Abfälle, oder für die Zerkleinerung von grünen Ästen mit einem Durchmesser von bis zu 13 cm verwendet werden. Der Trichter ist in einer geeigneten Höhe angebracht, um den Kraftaufwand für das Anheben des zu zerkleinernden Materials während der Arbeit zu verringern.

Die hydraulische Antriebswalze, deren Drehrichtung elektronisch über einen Griff gesteuert wird, der gleichzeitig als Sicherheitssperre für den Antrieb dient, ist mit einer elektronischen "NO STRESS"-Steuerung verbunden, die den Materialvorschub automatisch an den Zerkleinerungsaufwand anpasst.

La biotrituradora BIO 130-S permite reducir el volumen de residuos vegetales en un 45%. Permite triturar residuos de poda de vid, olivo, pino o palmera, así como residuos vegetales, incluidos residuos húmedos y fibrosos, o para la destrucción de ramas secas con un diámetro máximo de 13 cm. La tolva está situada a una altura adecuada para reducir el esfuerzo necesario para levantar el material a triturar durante el trabajo.

El rodillo de accionamiento hidráulico, cuyo sentido de giro se controla electrónicamente mediante una manivela que también actúa como bloqueo de seguridad del accionamiento, está conectado a una unidad de control electrónico "NO STRESS" que ajusta automáticamente la alimentación de material en función del esfuerzo de trituración.

Le bio-broyeur BIO 130-S permet de réduire de 45 % le volume des déchets végétaux. Il permet de broyer les résidus de taille de la vigne, de l'olivier, du pin ou du palmier, ainsi que les déchets humides et fibreux, ou de détruire les branches sèches de 13 cm de diamètre maximum.

La trémie est placée à une hauteur appropriée afin de réduire l'effort nécessaire pour soulever le matériel à broyer pendant le travail.

Le rouleau d'entraînement hydraulique, dont le sens de rotation est contrôlé électroniquement au moyen d'une poignée qui sert également de verrou de sécurité à l'entraînement, est relié à une unité de contrôle électronique « NO STRESS » qui ajuste automatiquement l'avancement du matériel en fonction de l'effort de broyage.



Rullo pick-up per l'avanzamento del materiale
Roll pick-up for material feed
Angetriebene Pick-up Walze für die Materialzufuhr
Rodillo pick-up para la alimentación de material
Rouleau pick-up pour l'alimentation en matériaux



Visualizzatore giri elettronico «NO STRESS»
Display device turns electronic "NO STRESS"
Elektronische Umdrehungen-Anzeige "NO STRESS"
Visualización electrónica de vueltas «NO STRESS»
Visualiseur électronique du régime "NO STRESS"



Timone con comandi
Drawbar with controls
Beichsel mit Bedienelementen
Barra de tiro con mandos
Barre de traction avec commandes

MOD							
mod.	cm	m ³ /h	rpm/min	nr (type)	nr	nr	nr
BIO 130-S	13	9 - 10	2850	2 (AX6I)	36	3	1

cod.	Ricambi	Spare parts	Ersatzteile	Recambios	Pièces de rechange
5023087	Motore a benzina HONDA	HONDA petrol engine	HONDA Benzinmotor	Motor de gasolina HONDA	Moteur à essence HONDA
5350116	Martello	Hammer	Hammer	Martillo	Marteau
5350161	Lama	Blade	Blatt	Cuchilla	Lames
5350295	Controlama	Counterblade	Gegenschlägel	Contracuchilla	Contre-lames
5314026	Filtro olio completo	Complete filter oil	Filterölfilter	Filtro aceite completo	Huile du filtre complète
5354025	Cinghia AX6I	Belt AX6I	Riemen AX6I	Correa AX6I	Courroie AX6I



**NO
STRESS**

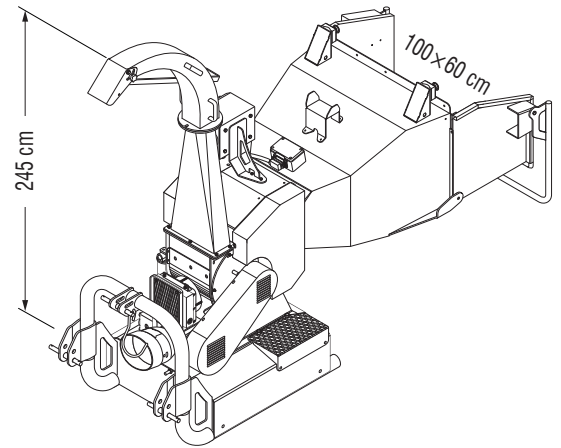

Maniglione di sicurezza
Safety handle
Sicherheitsgriff
Manilla de seguridad
Arceau de sécurité

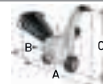
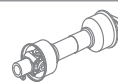
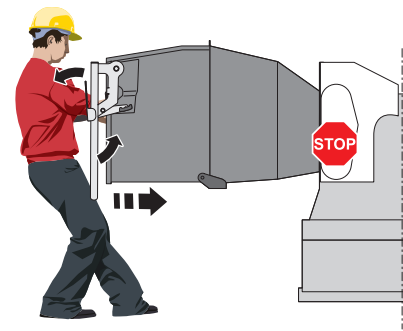

mod.	cod.	HP	type	kg	cm
BIO 160-T	1002732	50 - 100	T-50	655	270×129×245

Di serie	Standard equipment	Serienmässig	Estándar	De série	
<ul style="list-style-type: none"> Attacco a 3 punti cat. I-II Tubo di scarico registrabile Filtro olio a cartuccia Avanzamento del materiale gestito elettronicamente da sistema «NO STRESS» 2 rulli pick-up azionati indipendentemente Centralina elettronica di controllo triturazione Avviamento idraulico dei motori gestiti elettronicamente Pompa a portata fissa Scambiatore di calore Protezioni antinfortunistiche conformi alla normativa CE 	<ul style="list-style-type: none"> 3-point rear linkage cat. I-II Adjustable discharge pipe Oil cartridge filter Movement of material managed electronically by the «NO STRESS» system 2 rolls pick-up independently Electronic shredding control unit Hydraulic ignition of the electronically managed engines Pump with a fixed capacity Heat exchanger Protective equipment as per EC safety rules 	<ul style="list-style-type: none"> Dreipunktanbaubock Kat. I-II Regulierbares Entladungsrohr Ölfilterkartusche Materialeinführung wird elektronisch über das No-Stress-System gesteuert 2 angetriebene Pick-up Walzen Elektronische Steuerung der Zerkleinerung Hydraulische Inbetriebsetzung der elektrisch gesteuerten Motoren Konstantpumpe Wärmetauscher Unfallschutz nach EU-Vorschriften 	<ul style="list-style-type: none"> Enganche de 3 puntos cat. I-II Tubo de descarga orientable Filtro de aceite (cartucho) Exceso de material gestionado electrónicamente por el sistema «NO STRESS» 2 rodillos pick-up de accionamiento independiente Centralita electrónica de control de la trituración Arranque hidráulico de los motores gestionados de manera electrónica Bomba de capacidad fija Intercambiador de calor Protecciones de seguridad de acuerdo con la norma CE 	<ul style="list-style-type: none"> Attelage à 3 points cat. I-II Tuyau d'échappement réglable Filtre à huile à cartouche Avancement déchets géré électroniquement par le système «NO STRESS» 2 rouleaux pick-up indépendants Unité électronique de contrôle broyage Démarrage hydraulique des moteurs géré électroniquement Pompe à débit fixe Échangeur de chaleur Protections contre les accidents aux normes CE 	
cod.	A richiesta	On request	Auf Anfrage	Opcionales	Sur demande
5130005	Cardano T-50	PTO shaft T-50	Gelenkwelle T-50	Cardán T-50	Cardan T-50

BIO 160-T

BIO 160-T*Bio shredder for tractor***BIO 160-T**

Häcksler für Traktor

BIO 160-T*Biotriturador para tractor***BIO 160-T**

Broyeur pour tracteur



ORIGINAL MADE IN ITALY

Impiego**Use****Verwendung****Uso****Utilisation**

Il Biotrituratore BIO 160-T consente di triturare grandi quantità di rifiuti vegetali anche umidi e fibrosi aventi un diametro massimo di 15 cm.

La tramoggia, la cui forma inoltre rispetta tutte le normative europee attualmente in vigore, è posizionata ad altezza adeguata a ridurre lo sforzo di sollevamento.

I due rulli di trascinamento idraulici, il cui senso di rotazione viene controllato elettronicamente mediante il maniglione di comando esterno che funge anche da blocco di sicurezza del trascinamento, sono collegati ad un dispositivo elettronico «NO STRESS» di serie che regola automaticamente l'introduzione del materiale in base allo sforzo di triturazione.

The BIO 160-T shredder allows you to shred large amounts of vegetable waste, even moist and fibrous, with a maximum diameter of 15 cm.

The hopper, the shape of which complies with the current European regulations, is placed at the right height to reduce the lifting stress.

The two hydraulic drive rollers, the direction of rotation of which is controlled electronically by means of the external control handle which also serves as a safety lock for the drive, are connected to a standard «NO STRESS» electronic device which automatically adjusts the introduction of the material depending on the shredding stress.

Der BIO 160-T ermöglicht eine Zerkleinerung großer Mengen an Pflanzen-Abfällen, die auch feucht und faserig sein können, mit einem maximalen Durchmesser von 15 cm. Der Trichter, dessen Form allen aktuell gültigen europäischen Vorschriften entspricht, ist so positioniert, dass möglichst wenig Kraft zum Anheben der Abfälle benötigt wird. Die zwei hydraulischen Anlaufrollen, deren Drehrichtung elektronisch über den Steuerbügel geregelt wird, der gleichzeitig als Sicherheitsverriegelung für den Anlauf gilt, werden an eine elektrische, serienmäßige «NO STRESS»-Vorrichtung angeschlossen. Sie regelt die Zufuhr des Materials automatisch auf der Grundlage des Zerkleinerungsfortschritts.

El BIO 160-T permite triturar grandes cantidades de residuos vegetales, incluso húmedos y fibrosos, con un diámetro máximo de 15 cm.

La tolva, cuya forma respeta todas las normas europeas vigentes en la actualidad, está colocada a una altura adecuada para reducir el esfuerzo de elevación.

Los dos rodillos hidráulicos de arrastre, cuyo sentido de rotación se controla de forma electrónica mediante el tirador de mando externo que sirve también como bloqueo de seguridad del arrastre, están conectados a un dispositivo electrónico «NO STRESS» de serie que regula de forma automática la introducción del material en función del esfuerzo de trituración.

Le BIO 160-T permet de broyer de grandes quantités de déchets végétaux, y compris les déchets humides et fibreux, d'un diamètre maximum de 15 cm. La trémie, dont la forme respecte toutes les normes européennes actuellement en vigueur, est positionnée à une hauteur adaptée, de façon à réduire l'effort de soulèvement. Les deux rouleaux hydrauliques d'entraînement, dont le sens de rotation est contrôlé électroniquement via la poignée de commande externe qui sert également d'arrêt de sécurité de l'entraînement, sont reliés à un dispositif électronique «NO STRESS» de série, qui régule automatiquement l'introduction des déchets en fonction de l'effort de broyage.



2 rulli pick-up azionati indipendentemente
2 rolls pick-up independently
2 angetriebene Pick-up Walzen
2 rodillos pick-up de accionamiento independiente
2 rouleaux pick-up indépendants



Scambiatore di calore
Heat exchanger
Wärmetauscher
Intercambiador de calor
Échangeur de chaleur



Visualizzatore giri elettronico «NO STRESS»
Display device turns electronic «NO STRESS»
Elektronische Umdrehungen-Anzeige «NO STRESS»
Visualización electrónica de vueltas «NO STRESS»
Visualiseur électronique du régime «NO STRESS»

MOD						
mod.	cm	m ³ /h	rpm/min	nr (type)	nr	nr
BIO 160-T	15	20 - 25	2850	4 (SPB 1450)	3	1

cod.	Ricambi	Spare parts	Ersatzteile	Recambios	Pièces de rechange
5023072	Motore orbitale	Orbital motor	Motor augenhöhlen	Motor orbital	Motor orbitaire
5350161	Lama	Blade	Blatt	Cuchilla	Lames
5350162	Controlama	Counterblade	Gegenschlägel	Contracuchilla	Contre-lames
5433015	Cartuccia filtro olio	Cartridge filter oil	Patrine Filterölfilter	Cartucho filtro aceite	Huile du filtre de la cartouche
5433014	Filtro olio completo	Complete filter oil	Filterölfilter	Filtro aceite completo	Huile du filtre complète
5354072	Cinghia SPB-1450	Belt SPB-1450	Riemen SPB-1450	Correa SPB-1450	Courroie SPB-1450





MOTORIZED MINI-DUMPER
MINIRAUPENDUMPER
MINIDUMPER MOTORIZADO
MINI-TOMBEREAU MOTORISÉ



POWERED by
LONCIN



L'apparecchiatura è conforme ai requisiti richiesti dalla direttiva 2000/14/CE per la limitazione del rumore ambientale.

The equipment complies with the requirements of Directive 2000/14/EC for the limitation of environmental noise.

DC 300-B

Cassone ribaltabile con molle a gas e sponde estensibili
Dumper box with gas springs and extendable sides

Kippmulde mit Gasfedern und ausziehbaren Heckklappen

Caja de volquete con resortes de gas y compuertas traseras extensibles

Caisse à bascule avec ressorts à gaz et côtés extensibles



mod.	cod.	HP	Gear Shift	kg	kg	cm
DC 300-B	5446053	LONCIN 196 cc, 6,5 HP	3F+1R	300	178	77×87×116

Di serie	Standard equipment	Serienmässig	De serie	De série
<ul style="list-style-type: none"> • Motore a scoppio con avviamento manuale • Carrello cingolato con 3 marce avanti 1 indietro • Maniglie di guida in metallo con sistema di sicurezza • Sistema di avanzamento tramite cingoli • Velocità di avanzamento da 0-5 km/h • Cassone con capacità di carico di 300 kg, ribaltabile con molle a gas e sponde estensibili per aumentare lo spazio a disposizione per il carico • Larghezza dei cingoli 18 cm • Protezioni antinfortunistiche conformi alla normativa CE 	<ul style="list-style-type: none"> • Combustion engine with manual start • Crawler cart with 3 forward gears and 1 reverse gear • Metal driving handles with safety system • Track drive system • Advance speed from 0-5 km/h • Dumper box with a load capacity of 300 kg, gas-spring tipping and extendable sides to increase the space available for loading • Track width 18 cm • Protective equipment as per EC safety rules 	<ul style="list-style-type: none"> • Verbrennungsmotor mit Handstart • Raupenfahrwerk mit 3 Vorwärtsgängen und 1 Rückwärtsgang • Metallfahrgriffe mit Sicherheitssystem • Kettenantriebssystem • Fahrgeschwindigkeit 0-5 km/h • Behälter mit einer Kapazität von 300 kg, Gasfederklippung und ausziehbaren Heckklappen zur Vergrößerung des Laderaums • Spurbreite 18 cm • Schutzvorrichtungen nach EG-Richtlinien 	<ul style="list-style-type: none"> • Motor de gasolina con arranque manual • Carro de orugas con 3 marchas adelante 1 marcha atrás • Empuñaduras de conducción metálicas con sistema de seguridad • Sistema de tracción sobre orugas • Velocidad de avance de 0-5 km/h • Contenedor con una capacidad de carga de 300 kg, basculante con resorte de gas y compuertas traseras extensibles para aumentar el espacio disponible para la carga. • Ancho de vía de 18 cm • Protecciones de seguridad conforme a la normativa CE 	<ul style="list-style-type: none"> • Moteur à explosion avec démarrage manuel • Chariot sur chenilles avec 3 vitesses avant et 1 vitesse arrière • Poignées en métal avec système de sécurité • Système d'avancement par chenilles • Vitesse d'avancement de 0 à 5 km/h • Caisson d'une capacité de charge de 300 kg, basculement par ressort à gaz et hayons extensibles pour augmenter l'espace disponible pour le chargement • Largeur des chenilles 18 cm • Protections contre les accidents conformes aux normes CE



SCAN ME!

DC 500-B

Cassone ribaltabile **con molle a gas** e sponde estensibili
 Dumper box **with gas springs** and extendable sides
 Kippmulde **mit Gasfedern** und ausziehbaren Heckklappen
 Caja de volquete **con resortes de gas** y compuertas traseras extensibles
 Caisse à bascule **avec ressorts à gaz** et côtés extensibles

POWERED by
LONCIN



L'apparecchiatura è conforme ai requisiti richiesti dalla direttiva 2000/14/CE per la limitazione del rumore ambientale.

The equipment complies with the requirements of Directive 2000/14/EC for the limitation of environmental noise.



MOTORIZED MINI-DUMPER
 MINIRAUPENDUMPER
 MINIDUMPER MOTORIZADO
 MINI-TOMBREAU MOTORISÉ



SCAN ME!

DC 500-BH

Cassone con **ribaltamento idraulico** e sponde estensibili
 Hydraulic dumper box and extendable sides
 Hydraulische Kippmulde und ausziehbare Seitenwände
 Caja de volquete **hidráulica** y compuertas traseras extensibles
 Caisse à bascule **hydraulique** et côtés extensibles



MOD		HP				
mod.	cod.	HP	Gear Shift	kg	kg	cm
DC 500-B	5446052	LONCIN 196 cc, 6,5 HP	3F+1R	500	228	77×87×143
DC 500-BH	5446054	LONCIN 270 cc, 9 HP	3F+1R	500	264	77×87×143

Di serie	Standard equipment	Serienmässig	De serie	De série
<ul style="list-style-type: none"> • Motore a scoppio con avviamento manuale • Carrello cingolato con 3 marce avanti 1 indietro • Maniglie di guida in metallo con sistema di sicurezza • Sistema di avanzamento tramite cingoli • Velocità di avanzamento da 0-5 km/h • Cassone con capacità di carico di 500 kg, con sponde estensibili e ribaltabile con molle a gas o con pistone idraulico. • Larghezza dei cingoli 18 cm • Protezioni antinfortunistiche conformi alla normativa CE 	<ul style="list-style-type: none"> • Combustion engine with manual start • Crawler cart with 3 forward gears and 1 reverse gear • Metal driving handles with safety system • Track drive system • Advance speed from 0-5 km/h • Dumper box with a load capacity of 500 kg, with extendable sides and tipping with gas springs or hydraulic piston. • Track width 18 cm • Protective equipment as per EC safety rules 	<ul style="list-style-type: none"> • Verbrennungsmotor mit Handstart • Raupenfahrwerk mit 3 Vorwärtsgängen und 1 Rückwärtsgang • Metallfahrgriffe mit Sicherheitssystem • Kettenantriebssystem • Fahrgeschwindigkeit 0-5 km/h • Behälter mit einer Kapazität von 500 kg, mit ausziehbaren Seitenwänden und Kippen mit Gasfedern oder Hydraulikkolben. • Spurbreite 18 cm • Schutzvorrichtungen nach EG-Richtlinien 	<ul style="list-style-type: none"> • Motor de gasolina con arranque manual • Carro de orugas con 3 marchas adelante 1 marcha atrás • Empuñaduras de conducción metálicas con sistema de seguridad • Sistema de tracción sobre orugas • Velocidad de avance de 0-5 km/h • Contenedor con una capacidad de carga de 500 kg, con hayons extensibles y basculante con resorte de gas o pistón hidráulico. • Ancho de vía de 18 cm • Protecciones de seguridad conforme a la normativa CE 	<ul style="list-style-type: none"> • Moteur à explosion avec démarrage manuel • Chariot sur chenilles avec 3 vitesses avant et 1 vitesse arrière • Poignées en métal avec système de sécurité • Système d'avancement par chenilles • Vitesse d'avancement de 0 à 5 km/h • Caisson d'une capacité de charge de 500 kg, avec hayons extensibles et basculement par ressorts à gaz ou piston hydraulique. • Largeur des chenilles 18 cm • Protections contre les accidents conformes aux normes CE

CONDIZIONI RICHIESTA DI PRIMO AVVIAMENTO

COME RICHIEDERE IL SERVIZIO

Il servizio di primo avviamento permette di usufruire di un supporto tecnico specializzato, fornito da personale qualificato ZANON per minimizzare le problematiche di messa in funzione della macchina.

In cosa consiste il servizio di primo avviamento

Si tratta di un'attività accessoria alla vendita dei nostri prodotti mediante la quale si può usufruire della consulenza di tecnici specializzati per evitare problematiche dovute a un'errata installazione e messa in opera.

Le principali attività del tecnico

- Accurata verifica delle condizioni di installazione della macchina e il rispetto delle norme di installazione redatte dal costruttore.
- Verifica del collegamento della macchina al trattore.
- Suggerimenti e consigli relativi alle migliori impostazioni da utilizzare sulla macchina e sui dispositivi di controllo al fine di operare le selezioni più corrette alla tipologia di lavoro.
- Istruzioni sulla regolare manutenzione della macchina per ridurre i costi di mantenimento e poter lavorare in totale sicurezza.

Procedura di attivazione del servizio

Per attivare il servizio, accedere all'**area riservata** del nostro sito e scaricare l'apposito modulo per la richiesta di primo avviamento inserito nella cartella Modulistica.

La domanda dovrà essere compilata in tutte le sue parti, lasciando in bianco gli spazi indicati come *spazio riservato al personale Zanon*. Una volta completata, la richiesta dovrà essere inviata via email all'indirizzo **assistenza4@zanon.it**.

Al ricevimento del modulo compilato, ZANON farà una valutazione e invierà un preventivo in cui viene indicato il costo, i termini del servizio e tutte le opzioni elencate.

La richiesta di attivazione del servizio dev'essere inoltrata con un preavviso di **almeno 10 giorni lavorativi** per mail.

Note aggiuntive:

- È sempre necessaria la presenza in loco del personale tecnico del concessionario di riferimento.
- La macchina oggetto della richiesta di assistenza dovrà essere completamente assemblata in tutte le sue parti.
- I mezzi e le spese di trasporto sono a carico del cliente così come le eventuali spese di manodopera e le spese accessorie (vedi "Modulo richiesta primo avviamento")

Per ogni ulteriore approfondimento contattare il proprio rivenditore di zona.



CONDITIONS REQUIRED FOR INITIAL COMMISSIONING ON THE FIELD

HOW TO REQUEST THE SERVICE

The initial start-up service provides specialised technical support provided by ZANON's qualified staff to minimise machine start-up problems.

What does the initial commissioning service include

This is an add-on activity to the sale of our products through which you can benefit from the advice of specialised technicians to avoid problems caused by incorrect installation and commissioning.

Technician's main activities:

- Careful verification of the machine's set-up conditions and compliance with the installation regulations drawn up by the manufacturer;
- Checking the connection of the machine to the tractor;
- Suggestions and advice on the best set-up to use on the machine and on the control devices in order to select the most correct settings for the type of work;
- Instructions on regular maintenance of the machine to reduce maintenance costs and to be able to work in total safety.

Procedure for service activation

To activate the service, log in to the **reserved area** of our website and download the application form for the initial commissioning in the Forms folder.

The application must be completed in full, leaving the spaces indicated as *reserved for Zanon staff* blank. Once completed, the application should be sent by email to assistenza4@zanon.it.

Upon receipt of the completed form, ZANON will make an assessment and send a quotation indicating costs, terms of service and all options listed.

The service activation request must be submitted at **least 10 working days in advance** by email.

Additional notes:

- The on-site presence of the local dealer's technical staff is always required.
- The machine covered by the service request must be fully assembled in all its parts.
- Any vehicles and transport costs shall be covered by the customer as well as any labour costs and incidental expenses (see 'Initial commissioning request form').

For further information, please contact your local dealer.

VORAUSSETZUNGEN FÜR DIE ERSTE INBETRIEBNAHME

WIE MAN DEN DIENST ANFORDERT

Der Inbetriebnahmeservice bietet spezialisierte technische Unterstützung. Er wird von qualifiziertem ZANON-Personal durchgeführt, um Probleme bei der Inbetriebnahme der Maschine zu minimieren.

Worin besteht die Dienstleistung der Erstinbetriebnahme?

Hierbei handelt es sich um eine Zusatzaktivität zum Verkauf unserer Produkte, durch die du von der Beratung durch spezialisierte Techniker profitieren kannst, um Probleme aufgrund einer falschen Installation und Inbetriebnahme zu vermeiden.

Die Haupttätigkeiten des Technikers

- Sorgfältige Prüfung der Installationsbedingungen der Maschine und der Einhaltung der Installationsvorschriften des Herstellers.
- Überprüfung des Anschlusses der Maschine an den Traktor.
- Hinweise und Tipps zu den besten Einstellungen an der Maschine und den Steuergeräten, um die richtige Auswahl für die jeweilige Arbeit zu treffen.
- Anweisungen zur regelmäßigen Wartung der Maschine, um die Wartungskosten zu senken und sicher zu arbeiten.

Verfahren zur Aktivierung des Dienstes

Um den Service zu aktivieren, geht man in den **reservierten Bereich** unserer Website und lädt das entsprechende Formular für die erste Anfrage zur Inbetriebnahme aus dem Ordner Formulare herunter.

Der Antrag muss vollständig ausgefüllt werden, wobei die für das *Zanon-Personal reservierten Felder* freizulassen sind. Der ausgefüllte Antrag ist per E-Mail an assistenza4@zanon.it zu senden.

Nach Erhalt des ausgefüllten Formulars wird ZANON eine Bewertung vornehmen und einen Kostenvorschlag erstellen, der die Kosten, die Bedingungen der Dienstleistung und alle aufgeführten Optionen enthält.

Der Antrag auf Aktivierung des Dienstes muss **mindestens 10 Arbeitstage** im Voraus per E-Mail gestellt werden.

Weitere Hinweise:

- Die Anwesenheit des technischen Personals des betreffenden Händlers vor Ort ist immer erforderlich.
- Die Maschine, die Gegenstand der Serviceanfrage ist, muss in allen Teilen vollständig montiert sein.
- Die Transportmittel gehen zu Lasten des Kunden, ebenso wie die Arbeitskosten und die Nebenkosten (siehe „Formular für die Erstinbetriebnahme“)

Für weitere Informationen wende dich bitte an deinen lokalen Händler.



CONDICIONES NECESARIAS PARA LA PRIMERA PUESTA EN MARCHA

COMO SOLICITAR EL SERVICIO

El servicio de puesta en marcha inicial ofrece asistencia técnica especializada proporcionada por personal cualificado de ZANON para minimizar los problemas de puesta en marcha de la máquina..

¿En qué consiste el servicio inicial de puesta en marcha?

Se trata de una actividad auxiliar a la venta de nuestros productos a través de la cual podrá beneficiarse del asesoramiento de técnicos especializados para evitar problemas derivados de una incorrecta instalación y puesta en marcha.

Actividades principales del técnico

- Comprobación minuciosa de las condiciones de instalación de la máquina y del cumplimiento de las normas de instalación del fabricante..
- Comprobación de la conexión de la máquina al tractor.
- Sugerencias y consejos sobre los mejores ajustes que se deben utilizar en la máquina y los dispositivos de control para realizar las selecciones más correctas según el tipo de trabajo..
- Instrucciones sobre el mantenimiento periódico de la máquina para reducir los costes de mantenimiento y trabajar con seguridad.

Proceso de activación del servicio

Para activar el servicio, visite el **área reservada** de nuestro sitio web y descargue el formulario especial para la primera solicitud de puesta en marcha en la carpeta Formularios.

La solicitud debe cumplimentarse en su totalidad, dejando en blanco los *espacios indicados como reservados al personal de Zanon*. Una vez cumplimentada, la solicitud deberá enviarse por correo electrónico a **assistenza4@zanon.it**.

Una vez recibido el formulario cumplimentado, ZANON realizará una evaluación y enviará un presupuesto indicando el coste, las condiciones del servicio y todas las opciones indicadas.

La solicitud de activación del servicio debe realizarse con **al menos 10 días laborables** de antelación por correo electrónico.

Notas adicionales:

- Siempre es necesario que el personal técnico del distribuidor de la zona esté presente in situ.
- La máquina objeto de la solicitud de servicio debe estar completamente montada en todas sus partes.
- Los medios y gastos de transporte correrán a cargo del cliente, así como los costes de mano de obra y los gastos imprevistos (véase el «Formulario de solicitud de primera puesta en marcha»).

Para más información, no dudes en ponerte en contacto con tu distribuidor local.

CONDITIONS NÉCESSAIRES AU PREMIER DÉMARRAGE

COMMENT DEMANDER LE SERVICE

Le service de première installation offre une assistance technique spécialisée fournie par le personnel qualifié de ZANON afin de minimiser les problèmes de démarrage de la machine.

En quoi consiste le service de démarrage initial?

Il s'agit d'une activité accessoire à la vente de nos produits qui vous permet de bénéficier des conseils de techniciens spécialisés afin d'éviter les problèmes causés par une installation et une mise en service incorrectes.

Principales activités du technicien

- Vérification minutieuse des conditions d'installation de la machine et du respect des règles d'installation établies par le fabricant.
- Contrôle de l'attelage de la machine au tracteur.
- Suggestions et conseils sur les meilleurs réglages à utiliser sur la machine et les dispositifs de contrôle afin d'effectuer les sélections les plus correctes pour le type de travail.
- Instructions sur l'entretien régulier de la machine afin de réduire les coûts d'entretien et de pouvoir travailler en toute sécurité.

Procédure d'activation du service

Pour activer le service, connectez-vous à la **zone réservée** de notre site web et téléchargez le formulaire spécial pour la première demande de mise en service dans le dossier Formulaires.

Cette demande doit être complétée dans son intégralité, en laissant en blanc les espaces indiqués comme *étant réservés au personnel de Zanon*. Une fois complétée, la demande doit être envoyée par courrier électronique à **assistenza4@zanon.it**.

Dès réception du formulaire dûment rempli, ZANON procédera à une évaluation et enverra un devis indiquant le coût, les conditions du service et toutes les options énumérées.

La demande d'activation du service doit être faite **au moins 10 jours ouvrables à l'avance** par courrier électronique.

Notes complémentaires:

- La présence sur place du personnel technique du concessionnaire concerné est toujours requise.
- La machine faisant l'objet de la demande d'intervention doit être entièrement montée dans toutes ses parties.
- Les moyens de transport sont à la charge du client, de même que les coûts de main-d'œuvre et les frais accessoires (voir « Formulaire de demande de mise en service »).

Pour plus d'informations, veuillez contacter votre revendeur local.



CONDIZIONI GENERALI DI VENDITA

1. Le condizioni generali di vendita si applicano a tutte le Vendite di Prodotti tra ZANON S.r.l. ed i propri Clienti, e possono essere modificate con validità a partire dalla pubblicazione sul sito web www.zanon.it.

Deroghe ammissibili si hanno per differenti pattuizioni in forma scritta negli ordini o nelle conferme d'ordine. ZANON S.r.l. non si riterrà vincolata dalle Condizioni Generali del Cliente.

2. La vendita dovrà ritenersi conclusa:

- nel momento in cui il Cliente riceve da ZANON S.r.l. una conferma d'ordine conforme ai termini ed alle condizioni dell'ordine
- nel caso in cui il Cliente riceva da parte di ZANON S.r.l. una conferma d'ordine contenente termini difformi da quelli contenuti nell'Ordine, decorsi tre giorni lavorativi dalla data di ricezione della stessa senza che pervenga a ZANON S.r.l. contestazione scritta da parte del Cliente.
- o in assenza di conferma scritta da parte di ZANON S.r.l., nel momento in cui i prodotti saranno consegnati al Cliente.

Gli ordini regolarmente accettati da ZANON S.r.l. non potranno essere annullati e/o modificati dal Cliente senza il consenso scritto di ZANON S.r.l. Salvo diverso accordo scritto, ZANON S.r.l. non accetta resi dei Prodotti acquistati.

3. I prezzi dei prodotti saranno quelli indicati nel Listino Prezzi aggiornato sul sito www.zanon.it/area-riservata/listini-prezzi in vigore all'inoltro dell'Ordine da parte del Cliente, ovvero quelli comunicati da ZANON S.r.l. tramite Conferma d'ordine.

Il prezzo si riferisce al bene oggetto di vendita, franco fabbrica, ed ogni altro onere o accessorio è da ritenersi a parte. ZANON S.r.l. manterrà la proprietà dei prodotti fino al completo versamento del prezzo pattuito.

Cambiamenti su prezzi dovuti a cause di forza maggiore potranno essere applicati anche su Ordini confermati e non evasi, previa notifica.

4. La consegna avverrà entro il termine comunicato nella Conferma d'Ordine. Tale data è da considerarsi indicativa e non essenziale ai sensi dell'art. 1457 C.C., e non include i tempi di trasporto.

5. Il pagamento dell'ordine andrà effettuato in Euro (€) e secondo le indicazioni ed i termini pattuiti nella Conferma d'Ordine. Il pagamento cambiario graverà il cliente di commissioni ed interessi ad un tasso BCE maggiorato di 3 punti. Il mancato o ritardato pagamento, anche parziale, attribuisce a ZANON S.r.l. il diritto di sospendere immediatamente la consegna e ogni ulteriore prestazione da eseguirsi. Al Cliente moroso verranno applicati interessi di mora al tasso BCE, maggiorato di 7 punti (art.5, comma 2 D.Lgs. 231/2002)

6. Garanzia: ZANON S.r.l. garantisce che i prodotti forniti sono collaudati, esenti da vizi e/o difetti e sono idonei e conformi all'uso a cui sono destinati, per un periodo di 12 mesi decorrenti dalla data di consegna attestabile mediante attivazione della garanzia sul sito: www.zanon.it/area-riservata.

Il reclamo dovrà essere inoltrato entro 8 giorni dalla scoperta del vizio, nell'utilizzo diretto ovvero entro 8 giorni dalla comunicazione del vizio al Rivenditore dal Cliente finale via raccomandata a/r o pec, corredando la pratica di opportuna documentazione fotografica (vista d'insieme ex-ante eventuale intervento di riparazione, matricola e particolari del prodotto).

I prodotti dovranno essere inviati presso la Sede ZANON S.r.l. a spese del Cliente per l'effettuazione dei necessari controlli.

La garanzia non opera per i difetti dovuti a:

- danni da trasporto*
- uso imperito od improprio dei prodotti*
- riparazioni, modifiche o manomissioni di personale non autorizzato.*
- errate modalità di installazione dei nostri prodotti o utilizzo di pezzi errati utilizzati per l'installazione.*

ZANON S.r.l. non risponderà per motori, parti elettriche/elettroniche o elementi normalmente esposti a usura e consumo.

La responsabilità di ZANON S.r.l. è altresì esclusa se i vizi e/o difetti erano conosciuti o conoscibili dal Cliente e/o derivino da istruzioni o pezzi e apparecchiature forniti da quest'ultimo, o per danni a persone o cose provocati da errato o superficiale utilizzo dei nostri prodotti. L'eventuale vizio del prodotto, coperto da garanzia e notificato secondo modalità descritta, sarà sanato da ZANON S.r.l. - a propria discrezione - mediante sostituzione o riparazione, ma non saranno riconosciuti indennizzi per costi di manodopera, trasporti o spese sostenute in autonomia.

Per prassi interna, tutti i ricambi saranno fatturati all'atto della spedizione con pagamento in contrassegno: il riconoscimento della garanzia, previo ricevimento e verifica del pezzo guasto, darà diritto all'accredito.

7. I prodotti sono conformi alla legge Italiana e alle Direttive Europee. Sarà cura dell'Importatore estero assicurarsi delle conformità cui sottostare nel Paese di destino, impegnandosi a fornire dichiarazione di conformità, il manuale d'istruzioni, l'eventuale documentazione tecnica e la propria garanzia. La documentazione tecnica aggiornata è disponibile sul sito web: www.zanon.it, ed a questa il Cliente è tenuto a far riferimento.

8. ZANON S.r.l. avrà facoltà di risolvere, ai sensi art. 1456 CC, mediante comunicazione via raccomandata a/r o pec, la singola vendita nel caso di mancato ritiro o ricezione dei beni o nell'eventualità di inadempimento delle obbligazioni previste dai punti: 5; 7; 9.

9. I diritti di proprietà intellettuale sono di totale ed esclusiva proprietà di ZANON S.r.l., ed il Cliente si obbliga a non compiere alcun atto incompatibile con essi, quindi non utilizzerà o registrerà Marchi simili o confondibili con i Marchi ZANON, utilizzando invece Marchi e Diritti ZANON in ottemperanza alle istruzioni della Casa Madre e per i fini di cui alle presenti Condizioni di Vendita.

10. Il trattamento dei dati personali avverrà secondo quanto disposto dal Reg. UE 679/2016, nel rispetto della normativa vigente, in relazione all'attività commerciale ed obblighi contrattuali. Il titolare del trattamento dei dati personali è ZANON S.r.l.

11. Per ogni controversia è competente il foro di Padova, e per tutti i contratti, la legge applicabile sarà quella Italiana.

GENERAL TERMS AND CONDITIONS OF SALE

1. These general terms and conditions of sale shall apply to all Sales of Products between ZANON S.r.l. and its Customers and may be amended with effect from their publication on www.zanon.it website. Exceptions shall be granted following different written agreements set out in orders or order confirmations. The Customer's General Terms and Conditions shall not be considered to be binding on ZANON S.r.l.

2. A sale shall be deemed to have been concluded:

- When the Customer receives an order confirmation from ZANON S.r.l. that complies with the terms and conditions set out in the order;
- Upon three business days having elapsed since receipt of the order confirmation without ZANON S.r.l. receiving a written objection from the Customer if the Customer receives an order confirmation from ZANON S.r.l. containing terms and conditions other than those set out in the Order; or
- Upon the products being delivered to the Customer if no written confirmation is received from ZANON S.r.l.

Orders regularly accepted by ZANON S.r.l. may not be cancelled and/or changed by the Customer without ZANON S.r.l.'s written consent. Unless otherwise agreed in writing, ZANON S.r.l. shall not accept returns of purchased Products.

3. The prices of the products will be those indicated in the updated Price List on the site www.zanon.it/en/reserved-area/price-list in force at the time the Order is placed by the Customer, or those communicated by ZANON S.r.l. by means of Order Confirmation. The price shall refer to the item being sold, ex-works, with any other cost or accessory being considered as not included. ZANON S.r.l. shall retain ownership of the Products until the agreed price shall have been paid in full. Changes in prices due to force majeure events may also be applied to confirmed and unfulfilled Orders, subject to prior notice.

4. Delivery shall take place within the date as stated in the Order Confirmation. This date shall be considered to be approximate and not essential for the purposes of Section 1457 of the Italian Civil Code, and shall not include transport time.

5. Order payment shall be made in EUR (€) and in accordance with the instructions and deadline as set out in the Order Confirmation. Payment by promissory note shall cause the customer to incur commissions and interest at an ECB rate plus 3 points. Non-payment or delayed payment, whether in part or in whole, shall entitle ZANON S.r.l. to suspend forthwith delivery as well as any other service to be provided. Customers in arrears shall be charged default interest at the ECB rate plus 7 points (Article 5(2) of Legislative Decree 231/2002).

6. Warranty: ZANON S.r.l. hereby guarantees that the Products supplied are tested, free from defects and/or faults and are suitable for and compliant with their intended use for a period of 12 months from the date of delivery, as certified following activation of the warranty on www.zanon.it/en/reserved-area website.

Any complaint must be submitted within 8 days after discovery of the defect, in the case of direct use, or within 8 days after notification of the defect to the Retailer by the end Customer by registered letter with return receipt or by certified email [PEC], complete with adequate photographic evidence (overall view before any repair work, serial number and product details). The Products must be sent to ZANON S.r.l. headquarters at the Customer's expense in order that the necessary checks may be performed.

The warranty shall not apply to defects cause by:

- i) *damage during transportation*
- ii) *inappropriate or improper use of the products*
- iii) *repairs, changes or tampering by unauthorised personnel.*
- iv) *incorrect installation procedure or use of incorrect parts during installation.*

ZANON S.r.l. shall not be liable for fair wear and tear of motors, electrical/electronic parts or elements.

ZANON S.r.l. shall also not be held liable (i) if the Customer was aware of or knowledgeable about any defects and/or faults and/or if such defects and/or faults are deemed to arise from instructions or parts and equipment supplied by the Customer, or (ii) for damage to persons or property caused by improper or careless use of our products. Any defect in the product - covered under the warranty and notified as described - shall be remedied by ZANON S.r.l., at its sole discretion, by replacement or repair, but no compensation shall be granted for labour costs, transport or expenses incurred independently.

In accordance with corporate policies, all spare parts shall be invoiced at the time of dispatch: acknowledgement of warranty shall, subject to receipt of and checks performed on the faulty part, entitle the Customer to receive credit.

7. The products comply with Italian law and European Directives. It shall be the responsibility of the foreign importer to ensure product compliance in the country of destination, undertaking to provide a declaration of conformity, an operation manual, any technical documentation and its own warranty. Updated technical documentation is available on www.zanon.it, to which the Customer shall be required to refer.

8. Pursuant to section 1456 of the Italian Civil Code, ZANON S.r.l. shall, by serving a notice to be sent by registered letter with return receipt or by email, have the right to terminate individual sales in the event of failure to collect or receive the goods or in the event of failure to comply with the obligations under 5; 7; 9 hereof.

9. The intellectual property rights shall be the total and exclusive property of ZANON S.r.l., and the Customer undertakes to refrain from engaging in any conduct deemed to be in contrast with such rights. As a result, the Customer shall not use or register any Trademark similar to or capable of being confused with ZANON's Trademarks, using instead ZANON's Trademarks and Rights in compliance with ZANON's instructions and for the purposes set forth hereunder.

10. Personal data shall be processed in accordance with the provisions of Regulation EU 679/2016, in compliance with current legislation, in relation to commercial activity and contractual obligations. The data controller of personal data shall be ZANON S.r.l.

11. The court of Padua shall have jurisdiction over any dispute, while Italian law shall apply to all contracts.

ALLGEMEINE VERKAUFSBEDINGUNGEN

1. Die Allgemeine Verkaufsbedingungen gelten für alle Verkäufe von Produkten zwischen der Firma ZANON S.r.l. und deren Kunden. Die Bedingungen können mit Gültigkeit ab dem Zeitpunkt der Veröffentlichung auf der Website www.zanon.it geändert werden. Anderslautende Ausnahmeregelungen müssen in den Bestellungen oder Auftragsbestätigungen in Schriftform festgelegt werden. ZANON S.r.l. ist nicht an die Allgemeinen Geschäftsbedingungen der Kunden gebunden.

2. Der Verkauf gilt als abgeschlossen:

- sobald der Kunde eine Auftragsbestätigung von ZANON S.r.l. erhält, die den Auftragsbedingungen entspricht
- für den Fall, dass der Kunde eine Auftragsbestätigung von ZANON S.r.l. erhält, die vom Auftrag abweichende Bedingungen enthält, nach Ablauf von drei Werktagen ab dem Datum des Erhalts derselben, ohne dass ein schriftlicher Einspruch des Kunden bei ZANON S.r.l. eingegangen ist.
- wenn keine schriftliche Bestätigung durch ZANON S.r.l. vorliegt, in dem Moment, in dem die Produkte dem Kunden geliefert werden.

Aufträge, die von ZANON S.r.l. ordnungsgemäß angenommen werden, können vom Kunden nicht ohne schriftliche Zustimmung von ZANON S.r.l. storniert und / oder geändert werden. Vorbehaltlich anderslautender schriftlicher Vereinbarungen, akzeptiert ZANON S.r.l. keine Rücksendungen von gekauften Produkten.

3. Die Preise der Produkte sind die, die in der aktualisierten Preisliste auf der Website www.zanon.it/de/reservierter-bereich/preisliste angegeben sind, die zum Zeitpunkt der Bestellung des Kunden in Kraft ist, oder die, die von ZANON S.r.l. durch die Auftragsbestätigung mitgeteilt werden. Der Preis bezieht sich auf den Verkaufsgegenstand ab Werk. Sonstige Kosten oder Aufpreise sind gesondert zu berücksichtigen. ZANON S.r.l. behält sich das Eigentum an den Produkten bis zur vollständigen Bezahlung des vereinbarten Preises vor. Preisänderungen aufgrund höherer Gewalt können auch auf bestätigte und nicht abgewickelte Aufträge angewandt werden, sofern eine Benachrichtigung vorliegt.

4. Die Lieferung erfolgt innerhalb der in der Auftragsbestätigung mitgeteilten Frist. Diese Frist ist gemäß Art. 1457 italienisches ZGB [C.C.] als richtungswesend und nicht wesentlich zu betrachten und beinhaltet nicht die Transportzeit.

5. Die Zahlung des Auftrags erfolgt in Euro (€) gemäß den Angaben und Bedingungen, die in der Auftragsbestätigung vereinbart wurden. Dem Kunden werden Bearbeitungsgebühren und Zinsen in der Höhe des um 3 Punkte erhöhten EZB-Leitzinssatzes berechnet. Nichtzahlung oder Zahlungsverzug, auch teilweise, berechtigen ZANON S.r.l. zur sofortigen Einstellung der Lieferung sowie jeder weiteren Leistung. Dem säumigen Kunden werden Verzugszinsen in der Höhe des EZB-Leitzinssatzes zuzüglich 7 Punkte berechnet (Artikel 5, Absatz 2 italienische Gesetzesverordnung [D.Lgs.] 231/2002).

6. Garantie: ZANON S.r.l. gewährleistet, dass die gelieferten Produkte geprüft, frei von Mängeln und / oder Fehlern sind und für den bestimmungsmäßigen Zweck geeignet sind, und zwar für einen Zeitraum von 12 Monaten ab dem Lieferdatum, das durch die Aktivierung der Garantie auf der Website: www.zanon.it/de/reservierter-bereich nachweisbar ist.

Die Reklamation muss innerhalb von 8 Tagen nach dem Entdecken des Mangels bei direkter Nutzung erfolgen oder innerhalb von 8 Tagen nach der Mitteilung des Mangels an den Händler seitens des Endkunden per Einschreiben mit Rückschein oder per Mail an die zertifizierte Mail-Adresse. Zu diesem Zweck müssen die Unterlagen mit entsprechender Fotodokumentation (Gesamtansicht vor einer eventuellen Reparatur, Seriennummer und Produktdetails) beigelegt werden. Die Produkte müssen auf Kosten des Kunden zur Überprüfung an den Firmensitz von ZANON S.r.l. geschickt werden.

Die Garantie gilt nicht für Mängel aufgrund von:

- Transportschäden*
- mangelhafter oder unsachgemäßer Verwendung der Produkte*
- Reparaturen, Änderungen oder Eingriffe durch nicht autorisiertes Personal.*
- falschen Installationsweisen unserer Produkte oder Verwendung falscher Teile, die für die Installation verwendet wurden.*

ZANON S.r.l. haftet nicht für Motoren, elektrischen / elektronischen Teile oder Komponenten, die verschleißanfällig sind.

Zudem haftet ZANON S.r.l. auch nicht, wenn Mängel und / oder Fehler dem Kunden bekannt waren oder erkennbar gewesen sein müssten und / oder wenn sie auf Anweisungen oder Teile und Ausrüstungen zurückzuführen sind, die von Letzterem bereitgestellt wurden. Zudem haftet ZANON S.r.l. nicht für Personen- oder Sachschäden, die durch falsche oder fehlerhafte Benutzung der eigenen Produkte hervorgerufen worden sind. Jeder Produktmangel, der unter die Garantie fällt und in der beschriebenen Weise gemeldet wurde, wird von ZANON S.r.l. - nach eigenem Ermessen - durch Austausch oder Reparatur behoben, wobei jedoch keine Entschädigungen für Arbeit, Transport oder selbst getragene Kosten anerkannt werden.

Intern wird es so gehandhabt, dass alle Ersatzteile zum Zeitpunkt des Versands in Rechnung gestellt werden: Bevor die Garantie anerkannt wird, wird der fehlerhafte Teil nach seinem Eingang geprüft und erst dann erhält Kunde eine Gutschrift.

7. Die Produkte entsprechen dem italienischen Recht und den Europäischen Richtlinien. Es liegt in der Verantwortung des ausländischen Importeurs, die Konformität im Bestimmungsland sicherzustellen. Zu diesem Zweck ist dieser verpflichtet, eine Konformitätserklärung, das Benutzerhandbuch, etwaige technischen Unterlagen und seine Garantie zur Verfügung zu stellen. Die aktualisierten technischen Unterlagen sind auf der Website www.zanon.it verfügbar. Der Kunde ist verpflichtet, darauf Bezug zu nehmen.

8. ZANON S.r.l. ist befugt, den einzelnen Verkauf gemäß Art. 1456 ZGB per Einschreiben mit Rückschein oder Mail an die zertifizierte Mail-Adresse aufzuheben, wenn die Waren nicht abgeholt oder nicht empfangen werden oder wenn die in unter den Punkten 5, 7, 9 vorgesehenen Verpflichtungen nicht erfüllt werden.

9. Die geistigen Eigentumsrechte sind das vollständige und ausschließliche Eigentum von ZANON S.r.l. Der Kunde ist verpflichtet, keine Handlungen vorzunehmen, die damit unvereinbar sind. Er darf also keine Marken verwenden oder eintragen zu lassen, die den Marken von ZANON ähnlich oder mit diesen verwechselbar sind. Stattdessen muss er die Marken und Rechte von ZANON verwenden, die den Anweisungen des Mutterunternehmens und den in den Verkaufsbedingungen festgelegten Zwecken entsprechen.

10. Die Verarbeitung der personenbezogenen Daten erfolgt in Übereinstimmung mit den Bestimmungen der EU-Verordnung 679/2016, in Übereinstimmung mit der aktuellen Gesetzgebung, in Bezug auf die Geschäftstätigkeit und die vertraglichen Verpflichtungen. Der Verantwortliche für die Verarbeitung der personenbezogenen Daten ist ZANON S.r.l.

11. Das Gericht von Padua ist für alle Streitigkeiten zuständig. Für die Verträge findet italienisches Recht Anwendung.

CONDICIONES GENERALES DE VENTA

1. Las condiciones generales de venta se aplican a todas las Ventas de Productos entre ZANON S.r.l. y sus Clientes, y pueden ser modificadas con validez a partir de la publicación en la página web www.zanon.it.

Las excepciones admisibles se obtienen mediante otros acuerdos por escrito en los pedidos o en las confirmaciones de pedido. ZANON S.r.l. no estará sujeta a las Condiciones Generales del Cliente.

2. La venta deberá considerarse concluida:

- cuando el Cliente recibe una confirmación de pedido de ZANON S.r.l. de acuerdo con los términos y condiciones de pedido;
- cuando el Cliente recibe una confirmación de pedido de ZANON S.r.l. que contenga otros términos diferentes de aquellos contenidos en el Pedido, transcurridos tres días laborables desde la fecha de recepción del mismo, sin que ZANON S.r.l. reciba reclamación por escrito del Cliente;
- o si no hubiera una confirmación por escrito de ZANON S.r.l., en el momento en que los productos serán entregados al Cliente.

Los pedidos que ZANON S.r.l. ha aceptado no podrán ser anulados ni modificados por el Cliente sin el consentimiento por escrito de ZANON S.r.l. ZANON S.r.l. no acepta devoluciones de los Productos comprados, salvo acuerdo en contrario por escrito.

3. Los precios de los productos serán los indicados en la Lista de precios Zanon actualizada en el sitio web www.zanon.it/es/area-reservada/lista-de-precios, vigente a la fecha de envío del pedido, o bien el precio comunicado por Zanon en la confirmación del pedido.

El precio se refiere a la mercancía vendida, franco fábrica (Ex Works); otros gastos o costes adicionales serán cargados en cuenta por separado. ZANON S.r.l. se reserva la propiedad de los productos hasta el pago total del precio convenido. Los cambios en los precios a causa de fuerza mayor también se podrán aplicar a Pedidos confirmados y no servidos, previa notificación.

4. Los productos se entregarán en el plazo comunicado en la Confirmación de Pedido. Esta fecha debe considerarse indicativa y no vinculante de conformidad con el art. 1457 del Código Civil italiano, y no incluye los tiempos de transporte.

5. El pago del pedido se realizará en euros (€) y según las indicaciones y plazos convenidos en la Confirmación de Pedido. Las comisiones e intereses debido al pago de la letra de cambio correrán por cuenta del cliente al tipo aplicado por el BCE más 3 puntos porcentuales. En caso de incumplimiento o demora en el pago, incluso parcial, ZANON S.r.l. tendrá derecho a suspender de inmediato la entrega y cualquier otro servicio que deba cumplir. Los intereses de demora se aplicarán al cliente moroso al tipo aplicado por el BCE, más 7 puntos porcentuales (art. 5, apdo. 2 del DLeg. italiano 231/2002).

6. Garantía: ZANON S.r.l. garantiza que los productos suministrados están probados, libres de vicios y/o defectos y son adecuados y conformes al uso al que están destinados, durante un período de 12 meses a partir de la fecha de entrega que debe confirmarse activando la garantía en la página web: www.zanon.it/es/area-reservada.

La reclamación deberá enviarse antes de los 8 días siguientes a la fecha de descubrimiento del vicio, durante el uso directo, o antes de los 8 días siguientes a la fecha de la comunicación del vicio al Distribuidor por parte del Cliente final mediante carta certificada con acuse de recibo, o correo electrónico certificado, acompañando el expediente con la respectiva documentación fotográfica (vista general antes y después de posibles reparaciones, número de serie y detalles del producto). Los productos deberán enviarse al domicilio de ZANON S.r.l. por cuenta del Cliente para la realización de los controles necesarios.

La garantía no es válida para los defectos debidos a:

- daños de transporte*
- uso no autorizado o inadecuado de los productos*
- reparaciones, modificaciones o alteraciones realizadas por personal no autorizado.*
- métodos incorrectos de instalación de nuestros productos o uso de piezas inadecuadas para la instalación.*

ZANON S.r.l. no se asume ninguna responsabilidad por motores, piezas eléctricas/electrónicas o elementos normalmente expuestos a desgaste o consumibles.

ZANON S.r.l. tampoco es responsable si los vicios y/o defectos eran conocidos o debían ser conocidos por el Cliente y/o derivan de instrucciones o piezas y equipos proporcionados por este último, ni tampoco de daños a personas o bienes causados por un uso incorrecto o superficial de nuestros productos. Cualquier vicio en el producto, amparado por garantía y notificado de la manera descrita, será subsanado por ZANON S.r.l. - a su discreción - mediante sustitución o reparación, pero no se reconocerán indemnizaciones por gastos de mano de obra, transporte u otros gastos en los que se haya incurrido.

Por cuestiones internas, todas las piezas de repuesto serán facturadas en el momento del envío: el reconocimiento de la garantía, tras recibir y verificar la pieza defectuosa, dará derecho al crédito.

7. Los productos son conformes a la ley italiana y a las Directivas Europeas. El importador extranjero tendrá la responsabilidad de asegurarse del respeto de la conformidad en el país de destino, comprometiéndose a proporcionar una declaración de conformidad, el manual de instrucciones, posible documentación técnica y su propia garantía. La documentación técnica actualizada está disponible en la página web: www.zanon.it, y el Cliente deberá tomarla como referencia.

8. ZANON S.r.l. tendrá la facultad de resolver la venta, de conformidad con el art. 1456 del Código Civil italiano y mediante carta certificada con acuse de recibo o correo electrónico certificado, si el cliente no recogiera o recibiera la mercancía o en caso de incumplimiento de las obligaciones establecidas en los puntos: 5; 7; 9.

9. Los derechos de propiedad intelectual son propiedad total y exclusiva de ZANON S.r.l., y el Cliente se compromete a no realizar ningún acto incompatible con los mismos, por lo que no utilizará ni registrará Marcas similares ni confundibles con las Marcas ZANON, sino que utilizará las Marcas y Derechos ZANON respetando las instrucciones de la empresa matriz y para los fines a los que se refieren estas Condiciones de Venta.

10. Los datos personales serán tratados de acuerdo con lo establecido en el Reglamento UE 679/2016, en cumplimiento de la normativa vigente, en relación con la actividad comercial y las obligaciones contractuales. El responsable del tratamiento de datos personales es ZANON S.r.l.

11. En caso de litigios será competente el tribunal de Padua, y para todos los contratos, la ley aplicable será la ley italiana.

CONDITIONS GÉNÉRALES DE VENTE

1. Les conditions générales de vente s'appliquent à toutes les ventes de produits conclues entre ZANON S.r.l. et ses clients; toute éventuelle modification prendra effet à dater de sa publication sur le site web www.zanon.it. Pour être admises, toutes dérogations doivent être formalisées par des accords écrits dans les commandes ou dans les confirmations de commande. Les conditions générales du Client ne seront pas contraignantes pour ZANON S.r.l.

2. La vente sera considérée comme conclue:

- au moment où le client reçoit de ZANON S.r.l. une confirmation de commande conforme aux termes et aux conditions de la commande;
- au cas où le client recevrait de ZANON S.r.l. une confirmation de commande contenant des termes différents de ceux spécifiés dans la commande, une fois écoulé le délai de trois jours ouvrables à dater de sa réception à défaut de contestation écrite du client parvenue à ZANON S.r.l.;
- ou à défaut de confirmation écrite de la part de ZANON S.r.l., au moment où les produits seront livrés au client.

Les commandes régulièrement acceptées par ZANON S.r.l. ne pourront être annulées et/ou modifiées par le client à défaut de l'autorisation écrite de ZANON S.r.l. Sauf accord différent devant faire l'objet d'un écrit, ZANON S.r.l. n'accepte pas les rendus des produits achetés.

3. Les prix à jour des produits sont indiqués sur le tarif des prix ZANON dans le site www.zanon.it/fr/zone-reserve/liste-de-prix en vigueur au moment de l'envoi de la commande par le client, ou ceux communiqués par ZANON S.r.l. dans la confirmation de commande. Le prix se réfère au bien faisant l'objet de la vente, départ usine; toutes autres charges ainsi que tous autres frais accessoires seront considérés à part. ZANON S.r.l. conservera la propriété des produits jusqu'au versement du montant total du prix convenu. Tous changements apportés sur les prix imputables à des causes de force majeure pourront être appliqués également sur les commandes confirmées mais auxquelles il n'a pas encore été donné suite, moyennant communication préalable.

4. La livraison aura lieu dans le délai communiqué dans la confirmation de commande. Cette date doit être considérée comme indicative et non essentielle au sens de l'article 1457 du Code civil italien et elle ne comprend pas le temps de transport.

5. Le paiement de la commande devra être effectué en Euros (€) et selon les indications et les délais convenus dans la confirmation de commande. Le paiement par lettre de change comportera, à la charge du client, l'application de commissions et d'intérêts à un taux BCE majoré de 3 points. En cas de tout défaut ou retard de paiement, même partiel, à ZANON S.r.l. sera reconnu le droit de suspendre immédiatement la livraison non moins que toutes autres prestations devant être exécutées. Au client retardataire seront appliqués des intérêts moratoires au taux BCE, majoré de 7 points (article 5, alinéa 2 du décret législatif italien 231/2002)

6. Garantie: ZANON S.r.l. garantit que les produits fournis sont testés, exempts de vices et/ou de défauts et appropriés et conformes à l'usage auquel ils sont destinés, pour une période de 12 mois à compter de la date de livraison attestée moyennant l'activation de la garantie sur le site: www.zanon.it/fr/zone-reserve.

La réclamation devra être envoyée dans les 8 jours pour tout délai à dater de la découverte du vice, en cas d'utilisation directe, ou dans les 8 jours à compter de la communication du vice au Revendeur par le client final, par lettre recommandée A/R ou courrier électronique certifié PEC; elle devra être accompagnée d'une documentation photographique adéquate (vue d'ensemble ex-ante, éventuelle intervention de réparation, numéro de matricule et détails du produit). Les produits devront être expédiés au siège de ZANON S.r.l. aux frais du client aux fins de l'exécution des contrôles nécessaires.

La garantie ne joue pas pour les défauts imputables aux faits suivants:

- dommages occasionnés par le transport;*
- usage imprudent ou inapproprié des produits;*
- réparations, modifications ou manipulations effectuées par un personnel non autorisé;*
- modalités d'installation erronées de nos produits ou utilisation de matériels inappropriés pour l'installation.*

ZANON S.r.l. ne répondra pas des moteurs, des parties électriques/électroniques ou des éléments normalement soumis à l'usure et à la consommation.

La responsabilité de ZANON S.r.l. n'est pas engagée si le client connaissait, ou pouvait connaître, les vices et défauts, ou si ceux-ci seraient imputables à des instructions ou des matériels qu'il aurait fournis, ou encore pour tous dommages causés aux personnes et aux choses dérivant d'un usage impropre ou imprudent de nos produits. Il appartiendra à ZANON S.r.l. de remédier à l'éventuel vice du produit couvert par la garantie et communiqué conformément aux modalités spécifiées, moyennant, à sa seule discrétion, son remplacement ou sa réparation, mais aucune indemnisation pour les coûts de main-d'œuvre, de transport ou de frais autonomement exposés à défaut d'autorisation ne sera reconnue.

Par pratique interne, toutes les pièces de rechange seront facturées au moment de l'expédition: la reconnaissance de la garantie, suite à la réception et la vérification de la pièce défectueuse, donnera droit au remboursement par virement.

7. Les produits seront conformes à la loi italienne et aux directives européennes. Il appartiendra à l'importateur étranger de s'assurer des normes et règlements auxquels se conformer dans le pays de destination, et de s'engager à fournir toute déclaration de conformité, le manuel d'instructions, l'éventuelle documentation technique ainsi que sa propre garantie. La documentation technique mise à jour est à disposition sur le site web: www.zanon.it et le client est tenu à y faire référence.

8. ZANON S.r.l. aura la faculté, au sens de l'article 1456 du Code civil italien, de résilier une vente moyennant communication par lettre recommandée A.R. ou PEC, en cas de non retrait ou de réception des biens, ou en cas d'inexécution des obligations visées aux points 5, 7 et 9.

9. Les droits de propriété intellectuelle appartiennent exclusivement à ZANON S.r.l., et le client s'interdit d'accomplir tout acte incompatible avec lesdits droits, à savoir d'utiliser ou d'enregistrer des marques similaires ou susceptibles de prêter à confusion avec les Marques ZANON, et il s'oblige à utiliser les marques et les droits ZANON dans le respect des instructions de la maison-mère et pour les finalités spécifiées dans les présentes conditions de vente.

10. Le traitement des données personnelles sera effectué conformément aux dispositions du Règlement UE 679/2016 dans le respect de la législation en vigueur, relativement à l'activité commerciale et aux obligations contractuelles. Le titulaire du traitement des données personnelles est ZANON S.r.l.

11. Toute controverse sera soumise à la compétence du Tribunal de Padoue et pour tous les contrats la loi applicable sera la loi italienne.

INDICE A-Z

INDEX A-Z

INHALT VON A-Z

ÍNDICE A-Z

INDEX A-Z

Mod.	Pag.	Mod.	Pag.	Mod.	Pag.
AR ARIEGGIATORE	150	SLS-10	166	TMH-PRO	136
BC 30	184	SLS-8	159	TMH	134
BC 50-S	185	SLT-10	164	TMJ	126
BC 50-T	186	SLT-9.5	161	TMK-PRO	110
BC 60-E	187	SVE-10/12	167	TMK	108
BC 60-S	188	SVE-16 ECOLINE	169	TMO-SE	130
BC 60-T	189	SVE-20	173	TMO	128
BC 90-CINGO	192	SVEK-14/16	171	TMP	116
BC 90-S	190	SVI-20	175	TMR-PRO	100
BC 90-T	191	SVT-10/12	168	TMR	98
BIO 10-B	197	SVT-16 ECOLINE	170	TMS-PRO	70
BIO 130-S	198	SVT-20	174	TMS	68
BIO 160-T	200	SVT-25	176	TMU	66
BIO 8-B	194	SVTK-14/16	172	TN/DT SPECIAL	124
BIO 8-E	195	TCK	102	TPE	140
BIO 8-T	196	TDR	58	TPK	112
CIP 100-S	180	TF/DT SPECIAL	122	TRE-PRO	84
CIP 120-S	182	TFA	54	TRG	92
DC 300-B	202	TFB	64	TRL	86
DC 500-B DC 500-BH	203	TFG	52	TRP	96
DMI	50	TFL-S	34	TRV-PRO	90
FALK	148	TFL	32	TSF-PRO	74
IT-M	44	TFM/P	38	TSF	72
IT-PRO	48	TFM/R	88	TSM MONOLAMA	22
IT	46	TFO	56	TSM OFF-ROAD	24
LFG	62	TFX	36	TSP	60
MINI DUMPER DP 300	193	TFZ-PRO	42	TSS	30
RFG	94	TFZ	40	ZRA BILAMA	146
ROBY-PRO 550	144	TL	120	ZRF-T FALCIATRICE	154
ROBY-PRO 800	145	TLK-PRO	106	ZRF-TL FALCIATRICE	156
RYDER	26	TLK	104	ZRF FALCIATRICE	152
RYDER TRACTOR	28	TLP	114	ZTS-DT	78
SLE-10	162	TM	118	ZTS-MEGA	80
SLE-8	158	TMA-S	138	ZTS	76
SLE-9	160	TMC	132	ZTS TWIN	82





Certificazioni / Certifications:

ISO 9001 – Gestione Qualità / Quality management system

ISO 14001 – Gestione Ambientale / Environmental management system

ISO 45001 – Salute e Sicurezza sul Lavoro / Occupational health and safety management system

UNI EN 1090 - Conformità componenti strutturali in acciaio o alluminio / Conformity of steel or aluminium structural components



MEMBER



Via Madonnetta, 30 - 35011 CAMPODARSEGO (PD) ITALY

Tel. +39 049 9200433 | mail: info@zanon.it

zanon.it    

Dati tecnici ed immagini sono indicativi.

ZANON, nello sforzo di dare un prodotto innovativo sempre più aderente alle esigenze dei propri clienti, si riserva di apportare modifiche costruttive e tecniche in qualsiasi momento e senza alcun preavviso.

Technical data and images are indicative.

ZANON is committed to constantly improving its products to meet the needs of the sector. It therefore reserves the right to make construction and technical changes at any time and without notice.

Technische Daten und Fotos sind indikativ

ZANON ist bestrebt, ein innovatives Produkt anzubieten, das immer näher an den Bedürfnissen seiner Kunden liegt, und behält sich das Recht vor, Design und technische Änderungen jederzeit und ohne Vorankündigung vorzunehmen.

Los datos técnicos y las imágenes son indicativos.

En el esfuerzo de brindar a sus clientes un producto cada vez más cercano a sus exigencias, ZANON se reserva de aportar modificaciones constructivas y técnicas en todo momento y sin previa antelación.

Les données techniques et les images sont indicatifs.

Dans l'effort de proposer un produit répondant de plus en plus aux exigences de ses clients, ZANON se réserve le droit de apporter des modifications constructives et techniques en tout moment et sans préavis.