

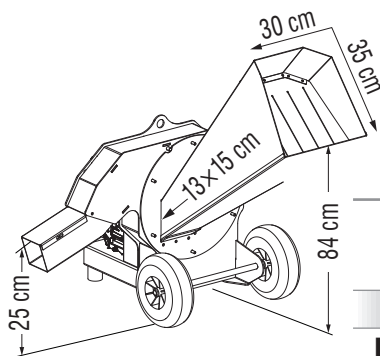





**NEW**







POWERED by  
**HONDA**

POWERED by  
**LAUNTOP**

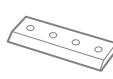

				
mod.	cod.	HP	kg	cm
<b>BC 50-S</b> HP 6,5	1003179	HONDA GX 200 HP 6,5	110	100×134×113
<b>BC 50-S</b> HP 6	1003670	LAUNTOP HP 6	110	100×134×113

Versione con motore a benzina - Petrol engine version - Benzinmotor Version - Versión motor a gasolina - Version moteur à essence

MOD							
mod.	cm	m <sup>3</sup> /h	rpm/min	nr	nr	nr	
<b>BC 50-S</b>	5	4	3100	8	2	2	



L'apparecchiatura è conforme ai requisiti richiesti dalla direttiva 2000/14/CE per la limitazione del rumore ambientale.

The equipment complies with the requirements of Directive 2000/14/EC for the limitation of environmental noise.

### Di serie

- Sistema di taglio professionale con lame in acciaio di altissima qualità
- Ruote imperforabili
- Setaccio di raffinazione regolabile
- Controlame
- Trasmissione a cinghia
- Protezioni antinfortunistiche conformi alla normativa CE

### Standard equipment

- Professional cutting system with steel blades of the highest quality
- Imperforable wheels
- Sieve of adjustable refining
- Counterblade
- Belt transmission
- Protective equipment as per EC safety rules

### Serienmässig

- Profi-Schneidsystem mit Klingen aus hochwertigem Stahl
- Pannenschutzräder
- Einstellbares Verfeinerungssieb
- Gegenklingen
- Riemenantrieb
- Unfallschutz nach EU-Vorschriften

### Estándar

- Sistema de corte profesional con hojas de acero de la más alta calidad
- Ruedas imperforables
- Tamiz de refinación ajustable
- Contracuchilla
- Transmisión por correa
- Protecciones de seguridad de acuerdo con la norma CE

### De série

- Système de coupe professionnel avec des lames en acier de la plus haute qualité
- Roues imperforables
- Tamis de raffinage réglable
- Contre-lame
- Transmission par courroie
- Protections contre les accidents aux normes CE

cod.	Ricambi	Spare parts	Ersatzteile	Recambios	Pièces de rechange
5350116	Martello	Hammer	Hammer	Martillo	Marteau
5350186	Lama	Blade	Klinge	Cuchilla	Lames
5350223	Controlama	Counterblade	Gegenmesser	Contracuchilla	Contre-lames
5354089	Cinghia BC 50	Cug belt BC 50	Keilriemen BC 50	Correa BC 50	Courroie BC 50
5023093	Motore HONDA HP 6,5	HONDA HP 6,5 motor	HONDA-motor HP 6,5	Motor HONDA HP 6,5	Moteur HONDA HP 6,5
5023139	Motore LAUNTOP HP 6	LAUNTOP HP 6 motor	LAUNTOP-motor HP 6	Motor LAUNTOP HP 6	Moteur LAUNTOP HP 6