

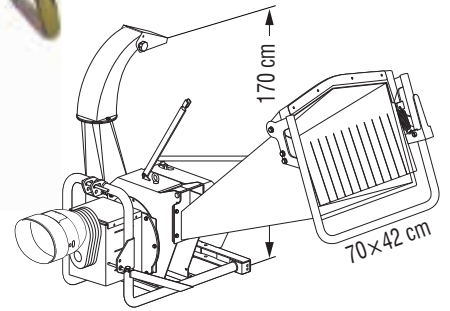











Maniglione di sicurezza
Safety handle
Sicherheitsgriff
Manilla de seguridad
Arceau de sécurité

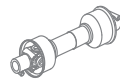

| | |
|---------|----------|
| BIO 8-T | Tractor |
| BIO 8-T | Traktor |
| BIO 8-T | Tractor |
| BIO 8-T | Tracteur |

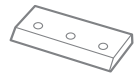
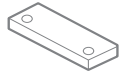

| | | | | | | |
|---|---|---|--|---|---|---|
|  |  |  |  |  |  | |
| mod. | cod. | HP | type | kg | cm | |
| BIO 8-T | 1002370 | 30 - 80 | T-40+RL | 270 | 200×112×190 | |
| MOD |  |  |  |  |  |  |
| mod. | cm | m ³ /h | rpm/min | nr | nr | nr |
| BIO 8-T | 8,5 | 6 - 5 | 2850 | 12 | 3 | 1 |

| Di serie | Standard equipment | Serienmässig | Estándar | De série |
|---|---|--|--|--|
| <ul style="list-style-type: none"> Attacco a 3 punti cat. I-II Tubo di scarico registrabile Filtro olio a cartuccia Scatola ingranaggi a bagno d'olio Gancio traino Avanzamento rullo regolabile idraulicamente Protezioni antinfortunistiche conformi alla normativa CE | <ul style="list-style-type: none"> 3-point rear linkage cat. I-II Adjustable discharge pipe Oil cartridge filter Oil bath gear box Tow hook Adjustable Working-speed controlled by hydraulic system. Protective equipment as per EC safety rules | <ul style="list-style-type: none"> Dreipunktanbauck Kat. I-II Regulierbares Entladungsrohr Ölfilterkartusche Ölbad-Getriebe Anhänggekupplung Hydraulisch einstellbarer Walzenvorschub Unfallschutz nach EU-Vorschriften | <ul style="list-style-type: none"> Enganche de 3 puntos cat. I-II Tubo de descarga orientable Filtro de aceite (cartucho) Caja de engranajes Gancho de remolque Rodillo de alimentación con regulación hidráulico. Protecciones de seguridad de acuerdo con la norma CE | <ul style="list-style-type: none"> Attelage à 3 points cat. I-II Tuyau d'échappement réglable Filtre à huile à cartouche Boîtier engrenages à bain d'huile Crochet de remorquage Avancement rouleau réglable hydrauliquement Protections contre les accidents aux normes CE |

| cod. | A richiesta | On request | Auf Anfrage | Opcionales | Sur demande |
|---------|----------------------------------|-----------------------------|------------------------------|----------------------------------|---------------------------------|
| 5130004 | Cardano T-40 RL | PTO shaft T-40 RL | Gelenkwelle T-40 RL | Cardán T-40 RL | Cardan T-40 RL |
| cod. | Ricambi | Spare parts | Ersatzteile | Recambios | Pièces de rechange |
| 5023072 | Motore orbitale | Orbital motor | Motor augenhöhlen | Motor orbital | Motor orbitaire |
| 2020046 | Scatola ingranaggi | Gearbox | Ölbad-Getriebe | Caja de engranajes | Bôte d'engrenages |
| 5210289 | Lama | Blade | Blatt | Cuchilla | Lames |
| 5210290 | Controlama | Counterblade | Gegenschlägel | Contracuchilla | Contre-lames |
| 5226590 | Martello | Hammer | Hammer | Martillo | Marteau |
| 5421011 | Pompa idraulica | Idraulic pump | Rad | Bomba hidraulica | Pompe idraulique |
| 5433015 | Cartuccia filtro olio | Cartridge filter oil | Patrine Filterölfilter | Cartucho filtro aceite | Huile du filtre de la cartouche |
| 5433014 | Filtro olio completo | Complete filter oil | Filterölfilter | Filtro aceite completo | Huile du filtre complète |
| 2131004 | Accoppiam. moltiplicatore-rotore | Attachment rotor-multiplier | Befestigungs rotor vermehrer | Acoplamiento rotor-multiplicador | Accouplem. multiplicateur-rotor |