

VERSIONE DOPPIA

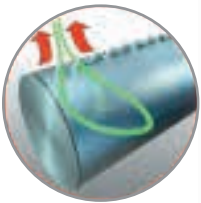





DOUBLE VERSION
DOPPELTE VERSION
VERSIÓN DOBLE
VERSION DOUBLE



JOYSTICK MULTIFUNZIONE

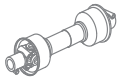
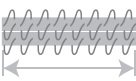

Sistema rapido per il cambio dei fili
Quick and tool-free wire replacement system
Schnelles und werkzeugloses Drahtwechselsystem
Sistema cambio de hilo rápido
Système rapide de remplacement du fil

								
mod.	cod.	HP	lt	rpm/min	type	cm	cm	kg
CST+DMI doppia	1002955	50 - 100	80	540	T-50 / T-60	75	220×175×110	620
CST+DMI doppia compatta	1003033	50 - 100	80	540	T-50 / T-60	75	168×165×110	510

Di serie	Standard equipment	Serienmässig	Estándar	De série
<ul style="list-style-type: none"> Attacco a 3 punti Cat. I-II Impianto oleodinamico completo di serbatoio, sistema filtrante e scambiatore di calore Joystick multifunzione Spostamento laterale idraulico apertura/chiusura Regolazioni posizione rotore regolabili idraulicamente Regolazione dei giri direttamente dal trattore Sistema rapido per il cambio dei fili Sistema antishock regolabile per l'attenuazione dell'urto Ruote di appoggio con cresta regolabili in altezza Protezioni antinfortunistiche conformi alla normativa CE 	<ul style="list-style-type: none"> 3-point linkage cat. I-II Hydraulic system complete with tank, filter system and heat exchanger Multifunction Joystick Hydraulic side shift opening/closing Hydraulically adjustable rotor positions RPM adjustment directly from the tractor Quick and tool-free wire replacement system Adjustable anti-shock system for shock absorption Height-adjustable crest wheels Protective equipment as per EC safety rules 	<ul style="list-style-type: none"> 3-Punkt-Anbau Kat. I-II Hydraulisches System komplett mit Tank, Filtersystem und Wärmetauscher Multifunktions-Joystick Hydraulische Seitenverschiebung öffnen/schließen Hydraulisch einstellbare Rotorpositionen Drehzahleinstellung direkt vom Traktor aus Schnelles und werkzeugloses Drahtwechselsystem Einstellbares Anfahrssicherung-System zur Stoßdämpfung Höhenverstellbare Räder mit Führung Unfallschutz nach EU-Vorschriften 	<ul style="list-style-type: none"> Enganche a 3 punto Cat. I-II Kit de centralita hidráulica completa de depósito, sistema filtrante e intercambiador de calor Joystick multifunción Desplazamiento lateral hidráulico apertura/cierre Regulación de la posición del rotor hidráulicamente Regulación del número de vueltas desde el tractor Sistema cambio de hilo rápido Sistema anti impacto, regulable para amortiguar golpe Rueda de apoyo con regulación en altura Protecciones de seguridad de acuerdo con la norma CE 	<ul style="list-style-type: none"> Attelage 3 points Cat. I-II Système hydraulique complet avec réservoir, système de filtrage et échangeur de chaleur Joystick multifonction Déplacement latéral hydraulique ouverture/fermeture Réglages hydraulique de la position du rotor Réglage de la vitesse géré directement de le tracteur Système rapide de remplacement du fil Système antichoc réglable pour atténuer l'impact Roues de support avec guide réglables en hauteur Protections contre les accidents aux normes CE

cod.	A richiesta	On request	Auf Anfrage	Opcionales	Sur demande
5130005	Cardano T-50	PTO shaft T-50	Gelenkwelle T-50	Cardán T-50	Cardan T-50
5130009	Cardano T-60	PTO shaft T-60	Gelenkwelle T-60	Cardán T-60	Cardan T-60
5411041	Ruota in ferro senza cresta	Smooth iron wheel	Glatte Eisenräder	Rueda de hierro lisa	Roue en fer lisse

CST+DMI DOPPIA

INDIPENDENT CASTLE with INTER-ROW MECHANICAL WEEDER

CST+DMI DOPPIA

MECHANISCHE UNKRAUTMÄHBÜRSTE

CST+DMI DOPPIA

DES BROZADORA INTERLÍNEAS MECÁNICA

CST+DMI DOPPIA

MACHINE À ÉBOURGEONNER AVEC PALPEUR MÉCANIQUE



ORIGINAL MADE IN ITALY

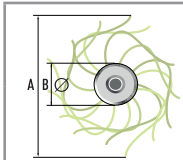

Ø A
450 mm

Ø B
130 mm

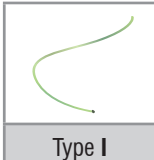

Type I



Sistema antishock regolabile per l'attenuazione dell'urto
Adjustable anti-shock system for shock absorption
Einstellbares Anfahrtsicherung-System zur Stoßdämpfung
Sistema anti impacto regulable para amortiguar golpe
Système antichoc réglable pour atténuer l'impact

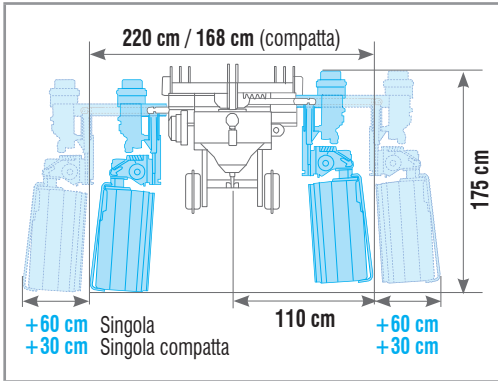
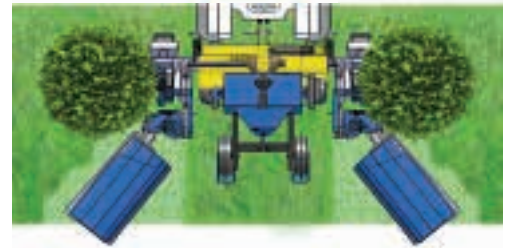

Regolazione giri rotore
Rotor speed control
Einstellung Rotorgeschwindigkeit
Regulación vueltas rotor
Réglage de la vitesse du rotor

Joystick multifunzione con base magnetica
Multifunction Joystick with magnetic base
Multifunktions-Joystick bedienung mit magnet
Joystick multifunción con base magnética
Joystick multifonction avec base magnétique



Scambiatore di calore
Heat exchanger
Wärmetauscher
Intercambiador de calor
Échangeur de chaleur

cod.	Ricambi	Spare parts	Ersatzteile	Recambios	Pièces de rechange
5450043	Bobina filo 630 mt Ø 4 mm	Wire 630 mt Ø 4 mm	Garnrolle 630 mt Ø 4 mm	Hilo 630 mt Ø 4 mm	Bobine de fil 630 mt Ø 4 mm